

32 YEARS
EXPERIENCE

ALCER
Aluminium Extrusion

PROFILE CATALOGUE

STANDARD SERIES

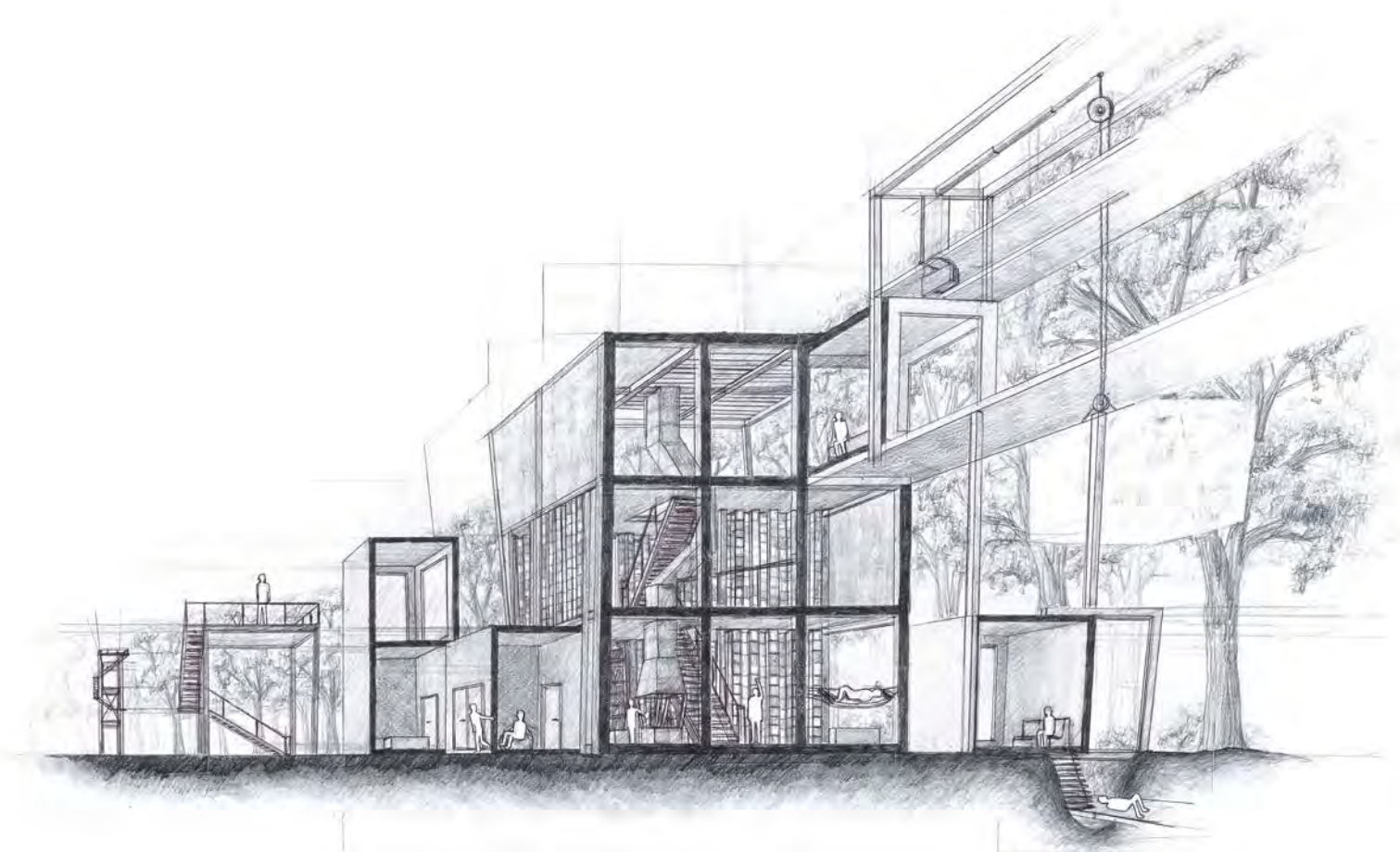

İÇİNDEKİLER INDEX



ALDOKS SERİSİ	19
<i>WINDOWS DOOR SYSTEM</i>	
AHŞAP KASA PROFİLLERİ	41
<i>WOODEN DOOR FRAME PROFILES</i>	
ARA BÖLME PROFİLLERİ	51
<i>PARTITION PROFILES</i>	
HC60 SERİ	59
<i>HC60 SERIE</i>	
DAR TUBA SERİSİ	87
<i>SLIDING WINDOWS SERIE</i>	
GENİŞ TUBA SERİSİ	99
<i>SLIDING WINDOWS SERIE</i>	
VERANDA PROFİLLERİ	109
<i>VERANDA PROFILES</i>	
KOMPOZİT PROFİLLERİ	129
<i>COMPOSITE PANEL PROFILES</i>	
KÜPEŞTE PROFİLLERİ	137
<i>HANDRAILS PROFILES</i>	
KARE KÜPEŞTE PROFİLLERİ	181
<i>SQUARE HANDRAILS PROFILES</i>	
CAM KÜPEŞTE PROFİLLERİ	191
<i>GLASS HANDRAILS PROFILES</i>	
MOBİLYA PROFİLLERİ	197
<i>FURNITURE PROFILES</i>	
SERAMİK PROFİLLERİ	223
<i>CERAMIC PROFILES</i>	
TEMİZ ODA PROFİLLERİ	251
<i>COOLING ROOM PROFILES</i>	
VİTRİN PROFİLLERİ	259
<i>SHOWCASE PROFILE</i>	
GÜNEŞ KIRICI PROFİLLER	263
<i>SUNBREAKER PROFILES</i>	
ZEMİN PROFİLLERİ	269
<i>FLOORING PROFILE</i>	
PANJUR PROFİLLERİ	283
<i>SHUTTER PROFILES</i>	
DENİZLİK, SÜPÜRGELİK PROFİLLERİ	291
<i>WINDOWSILL, SKIRTING PROFILES</i>	
BORU PROFİLLERİ	297
<i>PIPE PROFILES</i>	
DİKDÖRTGEN VE KARE PROFİLLER	301
<i>RECTANGULAR AND SQUARE PROFILES</i>	
KÖŞEBENT, T, U VE LAMA PROFİLLERİ	305
<i>KÖŞEBENT, T, U AND FLAT BAR PROFILES</i>	

ALCER
GLOBAL SOLUTION PARTNER

PROFİL KATALOĐU

ALDOKS SERİSİ

WINDOWS DOOR SYSTEM









★ Profil Ağırlıkları Teorik Olup Teslim Anındaki Ağırlık Geçerlidir

★ *Weight of profiles are theoretical, net weight will valid at the time of delivery.*

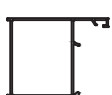

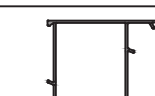
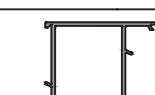
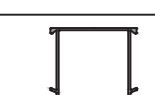
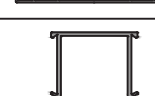
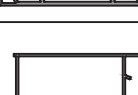

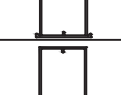

ALDOKS SERİSİ

WINDOWS DOOR SYSTEM

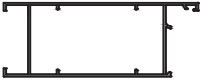
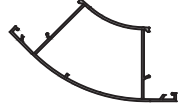
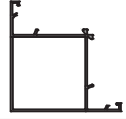
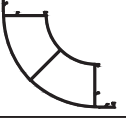
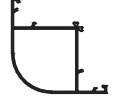
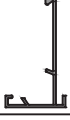
★ Yandaki profil birim ağırlıkları, bilgisayarda hesaplanmış teorik ağırlıklardır.

PROFİL KESİTİ	PROFİL KODU	PROFİL ADI	AĞIRLIK	ATALET MOMENTLERİ		SAYFA NO
				J_x (cm ⁴)	J_y (cm ⁴)	
	1339	Dar Kasa Profili	0,460 kg/m	5,38	1,88	
	1338	Dar Kanat Profili	0,549 kg/m	8,05	2,53	
	1340	Dar Orta Kayıt Profili	0,549 kg/m	6,05	3,99	
	1096	Kasa Profili	0,599 kg/m	8,60	5,58	
	2937	Kasa Profili	0,888 kg/m	11,47	8,09	
	1095	Kanat Profili	0,699 kg/m	13,42	6,10	
	2411	Kanat Profili	1,041 kg/m	18,20	8,80	
	1097	Orta Kayıt Profili	0,696 kg/m	10,48	8,44	
	2412	Orta Kayıt Profili	1,041 kg/m	14,12	12,26	
	2860	Geniş Kasa Profili	1,061 kg/m	33,19	13,67	
	2120	Geniş Kanat Profili	1,166 kg/m	44,27	14,45	
	2859	Geniş Orta Kayıt Profili	1,189 kg/m	43,58	15,81	
	2123	Takviyeli Kasa Profili	1,086 kg/m	34,34	14,41	
	2124	Takviyeli Kanat Profili	1,191 kg/m	34,37	16,37	

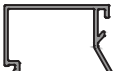
★ Yandaki profil birim ağırlıkları, bilgisayarda hesaplanmış teorik ağırlıklardır.

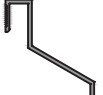
PROFİL KESİTİ	PROFİL KODU	PROFİL ADI	AĞIRLIK	ATALET MOMENTLERİ		SAYFA NO
				J_x (cm ⁴)	J_y (cm ⁴)	
	2121	Etek Profili	1,287 kg/m	63,94	18,08	
	4157	135° Dönüş Profili	0,974 kg/m	
	4158	90° Dönüş Profili	0,806 kg/m	
	4159	90° Dönüş Profili	1,520 kg/m	
	4160	90° Dönüş Profili	0,720 kg/m	
	4161	Tırnak Adaptörü	0,272 kg/m	
	4162	Düz Seri Çarpma Kapı Adaptörü	0,341 kg/m	
	4163	Düz Seri Çarpma Kapı Adaptörü	0,260 kg/m	
	1750	Cam Çıtası	0,215 kg/m	
	1090	Cam Çıtası	0,232 kg/m	
	1749	Tek Cam Çıtası	0,215 kg/m	
	2413	Tek Cam Çıtası	0,243 kg/m	
	1088	Tek Cam Çıtası	0,232 kg/m	
	1094	Damlalık	0,188 kg/m	

ALDOKS SERİSİ

WINDOWS DOOR SYSTEM













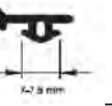

★ Yandaki profil birim ağırlıkları, bilgisayarda hesaplanmış teorik ağırlıklardır.

PROFİL KESİTİ	PROFİL KODU	PROFİL ADI	AĞIRLIK	ATALET MOMENTLERİ		SAYFA NO
				J_x (cm ⁴)	J_y (cm ⁴)	
	1404	Fugalı Te Bini	0,275 kg/m	
	1175	İspayolet Yuvası	0,135 kg/m	
	1176	Fugalı Te Bini	0,94 kg/m	
	1406	Dar U Bağlantı Profili	0,451 kg/m	
	1330	Geniş U Bağlantı Profili	0,627 kg/m	
	1114	Köşebent	0,823 kg/m	
	1333	Köşe Takozu	0,772 kg/m	
	1099	Köşe Takozu	1,122 kg/m	

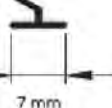
ALDOKS SERİSİ

WINDOWS DOOR SYSTEM

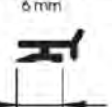





★ Yandaki profil birim ağırlıkları, bilgisayarda hesaplanmış teorik ağırlıklardır.

AKSESUAR KESİTİ	AKSESUAR KODU	AKSESUAR ADI	AĞIRLIK	PAKETLEME	SAYFA NO
 HA57-01 CAM FİTİLİ 1 Pk 100mt 6,10kg GLASS GASKET	HA57-01	Cam Fiteli	6,10 kg	1 Pk/ 100mt	
 HA57-02 CAM FİTİLİ 1 Pk 100mt 7,85kg GLASS GASKET	HA57-02	Cam Fiteli	7,85 kg	1 Pk/ 100mt	
 HA57-03 CAM FİTİLİ 1 Pk 100mt 8,80kg GLASS GASKET	HA57-03	Cam Fiteli	8,80 kg	1 Pk/ 100mt	
 HA57-04 OMEGA FİTİLİ 1 Pk 100mt 2,6kg OMEGA GASKET	HA57-04	Omega Fiteli	2,60 kg	1 Pk/ 100mt	
 HA57-05 OMEGA FİTİLİ 1 Pk 100mt 2,8kg OMEGA GASKET	HA57-05	Omega Fiteli	2,80 kg	1 Pk/ 100mt	
 HA59-06/1/1 HA59-06/1/2		Çakma Fitel	3,30 kg	1 Pk/ 100mt	
 HA59-06/1/3 HA59-06/1/4		Çakma Fitel	3,80 kg	1 Pk/ 100mt	
 HA57-15	HA57-15	Aldoks Fitel	1,80 kg ...	1 Pk/ 100mt	
 HA57-16	HA57-16	Aldoks Fitel	2,10 kg	1 Pk/ 100mt	
 HA57-18	HA57-18	Aldoks Çift Kulak Fitel	2,60 kg	1 Pk/ 100mt	
 HA57-19	HA57-19	Aldoks Çift Kulak Fitel	2,80 kg	1 Pk/ 100mt	
 HA57-22	HA57-22	Maçalı Fitel	2,30 kg	1 Pk/ 100mt	
 HA57-23	HA57-23	Maçalı Fitel	2,80 kg	1 Pk/ 100mt	
 HA57-24	HA57-24	Maçalı Fitel	3,20 kg	1 Pk/ 100mt	

ALDOKS SERİSİ

WINDOWS DOOR SYSTEM

★ Yandaki profil birim ağırlıkları, bilgisayararda hesaplanmış teorik ağırlıklardır.

AKSESUAR KESİTİ	AKSESUAR KODU	AKSESUAR ADI	AĞIRLIK	PAKETLEME	SAYFA NO
 HA32-15/1/8 ALDOKS MENTEŞE DÜZ KODU: HA32-15/1/8 ALDOKS MENTEŞE DÜZ ALDOKS MENTEŞE DÜZ	HA32-15/1/8	Aldoks Mentеше Düz	...	240 Ad/ 1 Paket	
 HA32-15/2/7 ALDOKS MENTEŞE FUGALI KODU: HA32-15/2/7 ALDOKS MENTEŞE FUGALI ALDOKS MENTEŞE FUGALI	HA32-15/2/7	Aldoks Mentеше Fugalı	...	240 Ad/ 1 Paket	
 HA32-08/5 İSPANYOLET KOL PARKALEZLİ ÇATALLI KODU: HA32-08/5 İSPANYOLET KOL PARKALEZLİ ÇATALLI	HA32-08/5	İspanyollet Kol Parmak İzli Çatallı	...	120 Ad/ 1 Paket	
 HA31-01 YAYLI SOSİS KOL KODU: HA31-01 YAYLI SOSİS KOL YAYLI SOSİS KOL	HA31-01	Yaylı Sosis Kol	...	50 Ad/ 1 Paket	
 HA31-09/2 GENİŞ AYNALI SOSİS KOL KODU: HA31-09/2 GENİŞ AYNALI SOSİS KOL	HA31-09/2	Geniş Aynalı Sosis Kol	...	25 Ad/ 1 Paket	
 HA31-11 KIVRIK BORU KOL KODU: HA31-11 KIVRIK BORU KOL KIVRIK BORU KOL	HA31-11	Kıvrık Boru Kol	...		
 HA31-28 BANT LAMA KOL KODU: HA31-28 BANT LAMA KOL BANT LAMA KOL	HA31-28	Bant Lama Kol	...		
 HA31-16 YARIM AY DÖKÜM KOL KODU: HA31-16 YARIM AY DÖKÜM KOL YARIM AY DÖKÜM KOL	HA31-16	Yarım Ay Döküm Kol	...	30 Ad/ 1 Paket	
 HA32-16/2 DÜZ ALDOKS GEÇME MENTEŞE KODU: HA32-16/2 DÜZ ALDOKS GEÇME MENTEŞE DÜZ ALDOKS GEÇME MENTEŞE	HA32-16/2	Düz Aldoks Geçme Mentеше	...	240 Ad/ 1 Paket	
 HA32-19/3-4E ÜSTTEN MONTELİ MENTEŞE KODU: HA32-19/3-4E ÜSTTEN MONTELİ MENTEŞE	HA32-19/3-4E	Üstten Monteli Mentеше	...	250 Ad/ 1 Paket	
 HA32-05/1 ALDOKS DİLLİ KİLİT KARŞILIĞI KODU: HA32-05/1 ALDOKS DİLLİ KİLİT KARŞILIĞI	HA32-05/1	Aldoks Dilli Kilit Karşılığı	...	550 Ad/ 1 Paket	
 HA33-05/2 ALDOKS MAKARALI KİLİT KARŞILIĞI KODU: HA33-05/2 ALDOKS MAKARALI KİLİT KARŞILIĞI	HA33-05/2	Aldoks Makaralı Kilit Karşılığı	...	550 Ad/ 1 Paket	
 HA33-04/2 ALÜMİNYUM KAPI ALTI FIRÇASI KODU: HA33-04/2 ALÜMİNYUM KAPI ALTI FIRÇASI	HA33-04/2	Alüminyum Kapı Altı Fırçası	...	100 Ad/ 1 Paket	
 HA32-34/1 ALDOKS PİM TAKIMI KODU: HA32-34/1 ALDOKS PİM TAKIMI	HA32-34/1	Aldoks Pim Takımı	...	100 Ad/ 1 Paket	

★ Yandaki profil birim ağırlıkları, bilgisayarda hesaplanmış teorik ağırlıklardır.

AKSESUAR KESİTİ	AKSESUAR KODU	AKSESUAR ADI	AĞIRLIK	PAKETLEME	SAYFA NO
 HA32-31 ALÜMİNYUM İSPANYOLET TİJA ÇUBUĞU RULAVANTİ 200 KÖLİ 40/11/11 1/2/20/10/10 DİRENİMLİ VE KESİCİ	HA32-31	Alüminyum İspanyolet Tij Çubuğu	...	100 Ad/ 1 Paket	
 HA31-26 SAPLAMA TAKIMI 1 Pk 50 Tix 0,30 kg NUT KİT	HA31-26	Saplama Takımı	...	50 Ad/ 1 Paket	
 HA33-08/2 80 VOLTIZM YAKIŞTIR MAKAS 13CM RULAVANTİ 200 KÖLİ 40/11/11 1/2/20/10/10 TORNAL HİSTERİSİZ TRANSFORMASYONLUK 13CM	HA33-08/2	Aldoks Vasistas Makas 13 cm	...	700 Ad/ 1 Paket	
 HA33-08/1 80 VOLTIZM YAKIŞTIR MAKAS 22CM RULAVANTİ 200 KÖLİ 40/11/11 1/2/20/10/10 TORNAL HİSTERİSİZ TRANSFORMASYONLUK 22CM	HA33-08/1	Aldoks Vasistas Makas 22 cm	...	500 Ad/ 1 Paket	
 HA33-16 GÖMME SÜRGÜ RULAVANTİ 200 KÖLİ 40/11/11 1/2/20/10/10 ALÜMİNYUM HİSTERİSİZ 13CM	HA33-16	Gömme Sürgü	...	500 Ad/ 1 Paket	
 HA32-27/1 BAĞ DENEYİ ORTA KAYIT BAĞLANTI 1 Pk 100 Ad 200 mg METAL LARGE HULLERIN CONNECTOR	HA32-27/1	Saç Geniş Orta Kayıt Bağlantı	...	100 Ad/ 1 Paket	
 HA32-28/2 BAĞ ALYAN BAĞLANTI 1 Pk 250 Ad 200 mg 20.5kg METAL ALIEN CONNECTOR	HA32-28/2	Saç Alyan Bağlantı	...	250 Ad/ 1 Paket	
	HA34-04-N	153 20 mm 62 mm Barelli Nikel Kilit	...	30 Ad/ 1 Paket	
	HA35-15/1	269 WC 20 mm Aldoks Kilit Barelsiz Nikel	...	40 Ad/ 1 Paket	
	HA34-01/2/2	68 mm Cerman Mandallı Nikel Barel	...	12 Ad/ 1 Paket	
 HA32-22/3 ALDOKS BABA MENTEŞE RULAVANTİ 200 KÖLİ 40/11/11 1/2/20/10/10 ALÜMİNYUM HİSTERİSİZ	HA32-22/3	Aldoks Baba Menteşe	...	120 Ad/ 1 Paket	
	HA33-15	Aldoks Vasistas Çarpma	...	500 Ad/ 1 Paket	
	HA31-25	Kare Kol	...	180 Ad/ 1 Paket	
	HA31-21	D Kol	...	40 Ad/ 1 Paket	

★ Yandaki profil birim ağırlıkları, bilgisayarla hesaplanmış teorik ağırlıklardır.

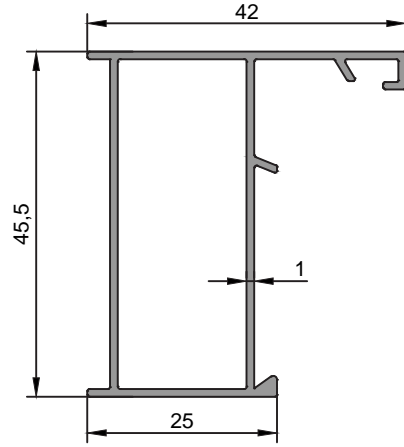

1339
Dar Kasa Profili
0,460 kg/m
Jx=5,38 cm ⁴ Jy=1,88 cm ⁴

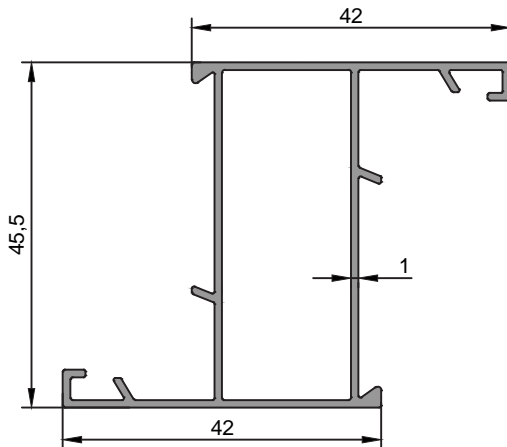

1338
Dar Kanat Profili
0,549 kg/m
Jx=8,05 cm ⁴ Jy=2,53 cm ⁴

ALDOKS SERİSİ

WINDOWS DOOR SYSTEM

★ Yandaki profil birim ağırlıkları, bilgisayarla hesaplanmış teorik ağırlıklardır.

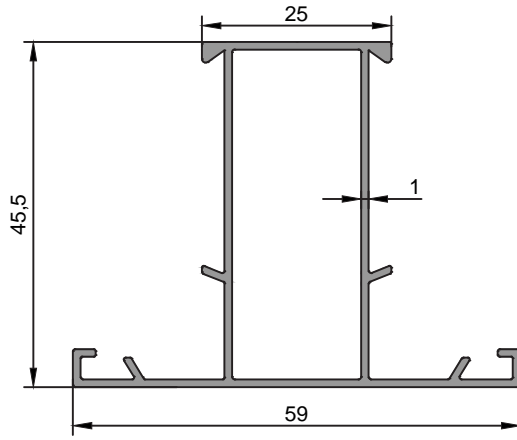

1340
Dar Orta Kayıt Profili
0,549 kg/m
$Jx=6,05 \text{ cm}^4$ $Jy=3,99 \text{ cm}^4$

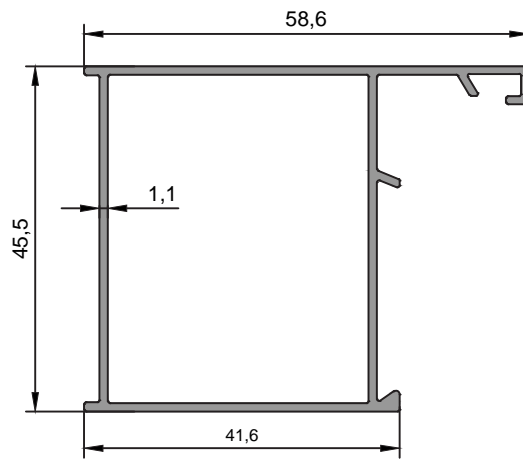

1096
Kasa Profili
0,599 kg/m
$Jx=8,60 \text{ cm}^4$ $Jy=5,58 \text{ cm}^4$

★ Yandaki profil birim ağırlıkları, bilgisayarla hesaplanmış teorik ağırlıklardır.

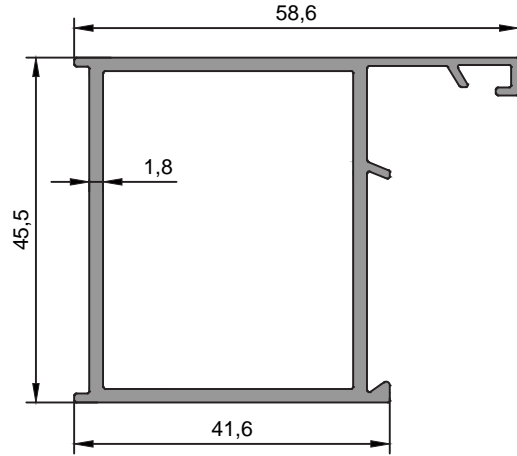

2937
Kasa Profili
0,888 kg/m
Jx=11,47 cm ⁴ Jy=8,09 cm ⁴

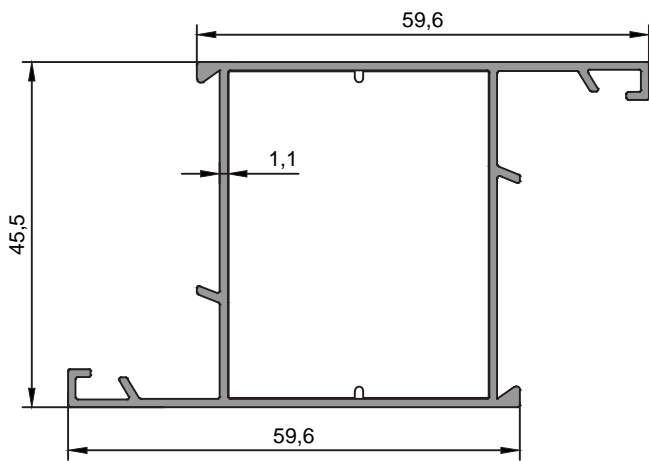

1095
Kanat Profili
0,699 kg/m
Jx=13,42 cm ⁴ Jy=6,10 cm ⁴

ALDOKS SERİSİ

WINDOWS DOOR SYSTEM

★ Yandaki profil birim ağırlıkları, bilgisayarla hesaplanmış teorik ağırlıklardır.

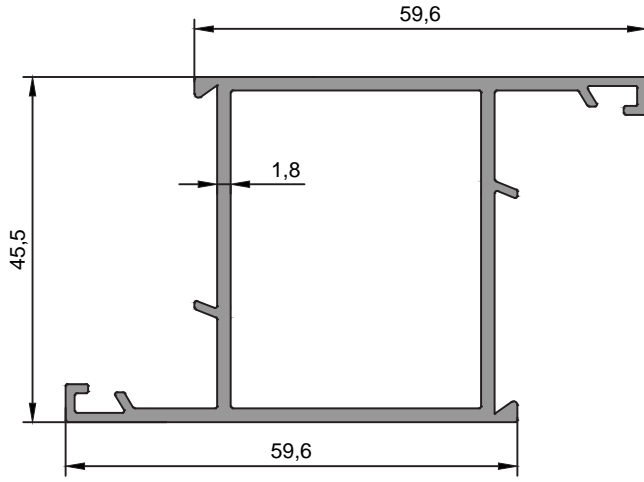

2411
Kanat Profili
1,041 kg/m
$Jx=18,20 \text{ cm}^4$ $Jy=8,80 \text{ cm}^4$

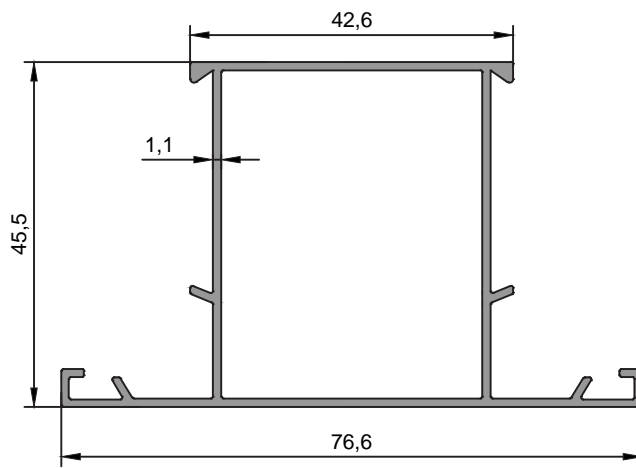

1097
Orta Kayıt Profili
0,696 kg/m
$Jx=10,48 \text{ cm}^4$ $Jy=8,44 \text{ cm}^4$

★ Yandaki profil birim ağırlıkları, bilgisayarla hesaplanmış teorik ağırlıklardır.

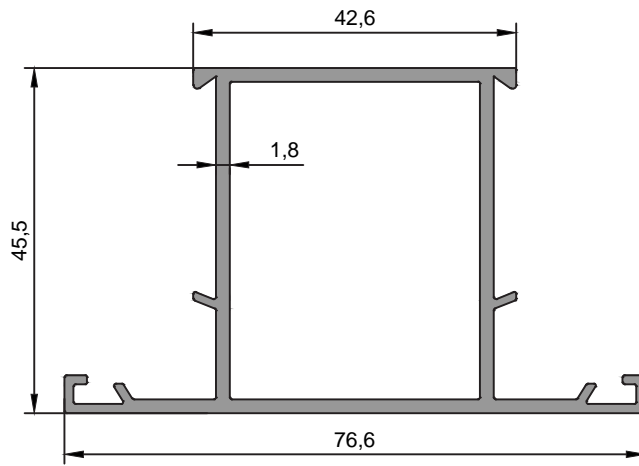

2412
Orta Kayıt Profili
1,041 kg/m
Jx=14,12 cm ⁴ Jy=12,26 cm ⁴

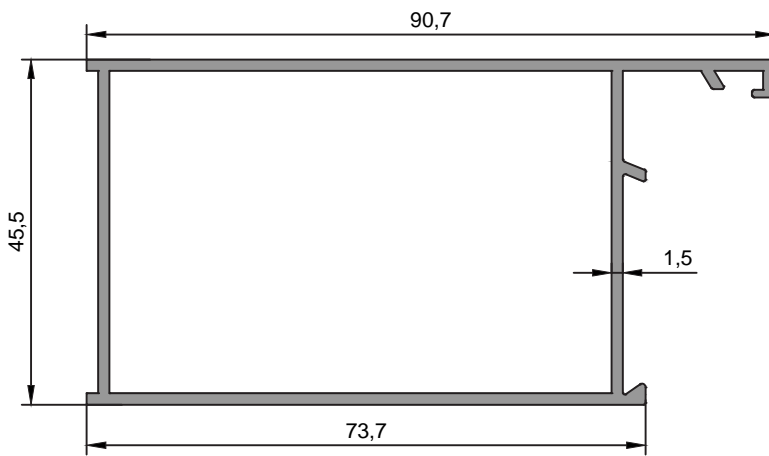

2860
Geniş Kasa Profili
1,061 kg/m
Jx=33,19 cm ⁴ Jy=13,67 cm ⁴

ALDOKS SERİSİ

WINDOWS DOOR SYSTEM

★ Yandaki profil birim ağırlıkları, bilgisayarla hesaplanmış teorik ağırlıklardır.

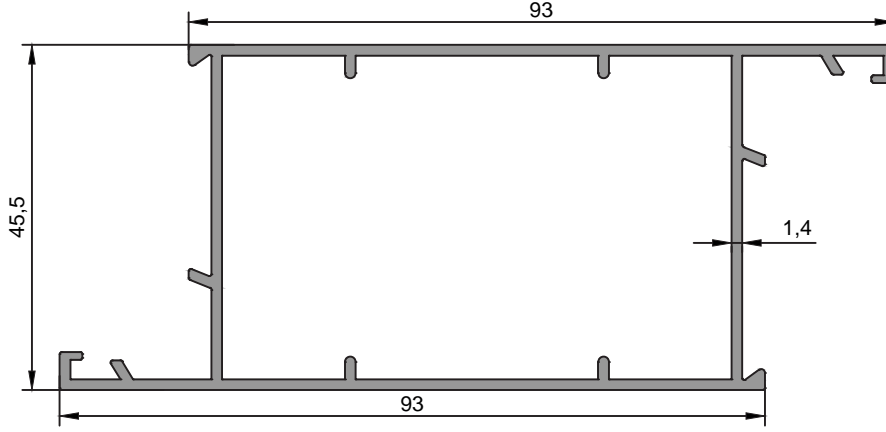

2120
Geniş Kanat Profili
1,166 kg/m
$Jx=44,27 \text{ cm}^4$ $Jy=14,45 \text{ cm}^4$

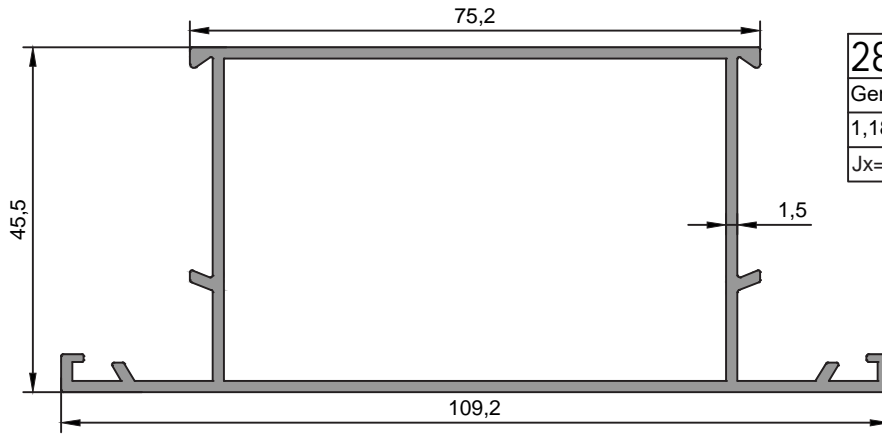

2859
Geniş Orta Kayıt Profili
1,189 kg/m
$Jx=43,58 \text{ cm}^4$ $Jy=15,81 \text{ cm}^4$

★ Yandaki profil birim ağırlıkları, bilgisayarda hesaplanmış teorik ağırlıklardır.

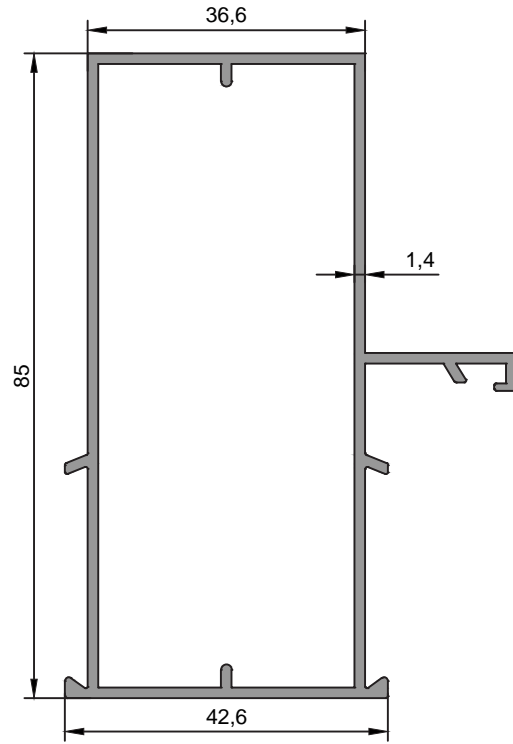

2123
Takviyeli Kasa Profili
1,086 kg/m
Jx=34,34 cm ⁴ Jy=14,41 cm ⁴

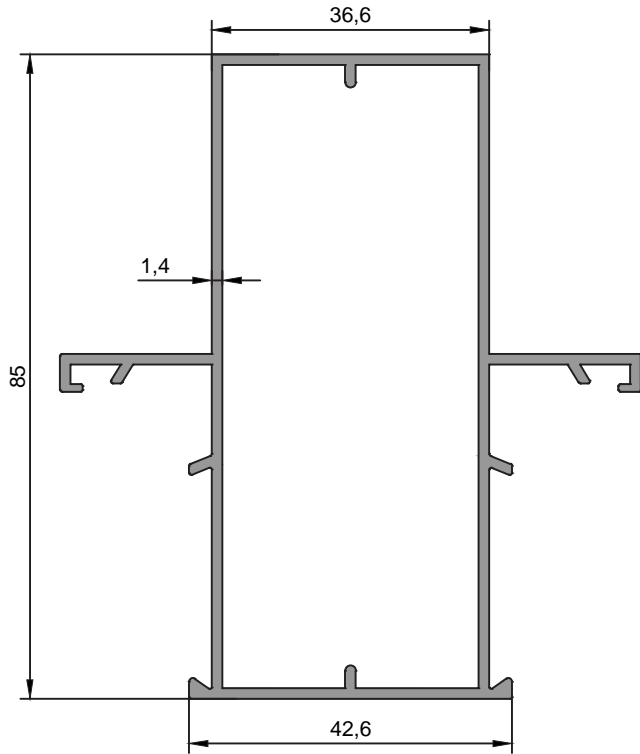

2124
Takviyeli Kanat Profili
1,191 kg/m
Jx=34,37 cm ⁴ Jy=16,37 cm ⁴

ALDOKS SERİSİ

WINDOWS DOOR SYSTEM

2121
Etek Profili
1,287 kg/m
Jx=63,94 cm ⁴ Jy=18,08 cm ⁴

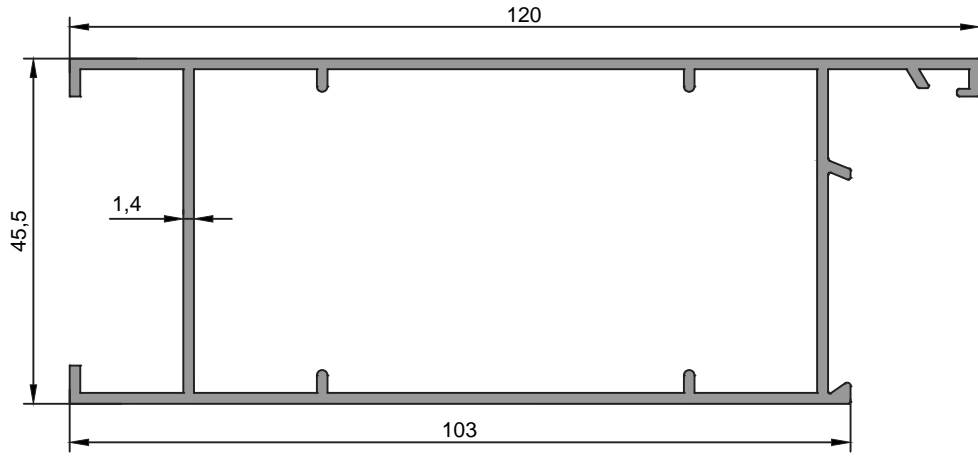

★ Yandaki profil birim ağırlıkları, bilgisayararda hesaplanmış teorik ağırlıklardır.

★ Yandaki profil birim ağırlıkları, bilgisayarda hesaplanmış teorik ağırlıklardır.

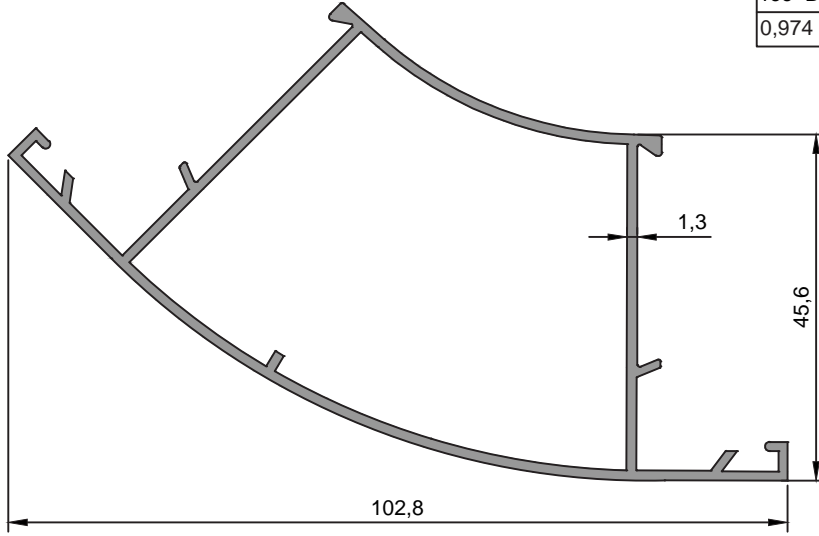

4157
135° Dönüş Profili
0,974 kg/m

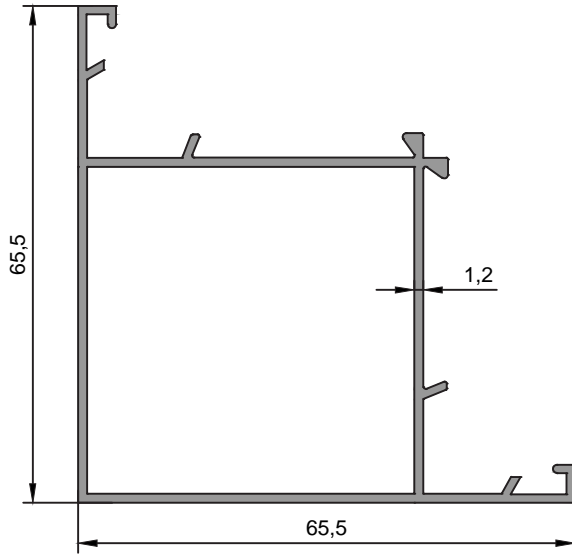

4158
90° Dönüş Profili
0,806 kg/m

★ Yandaki profil birim ağırlıkları, bilgisayarda hesaplanmış teorik ağırlıklardır.

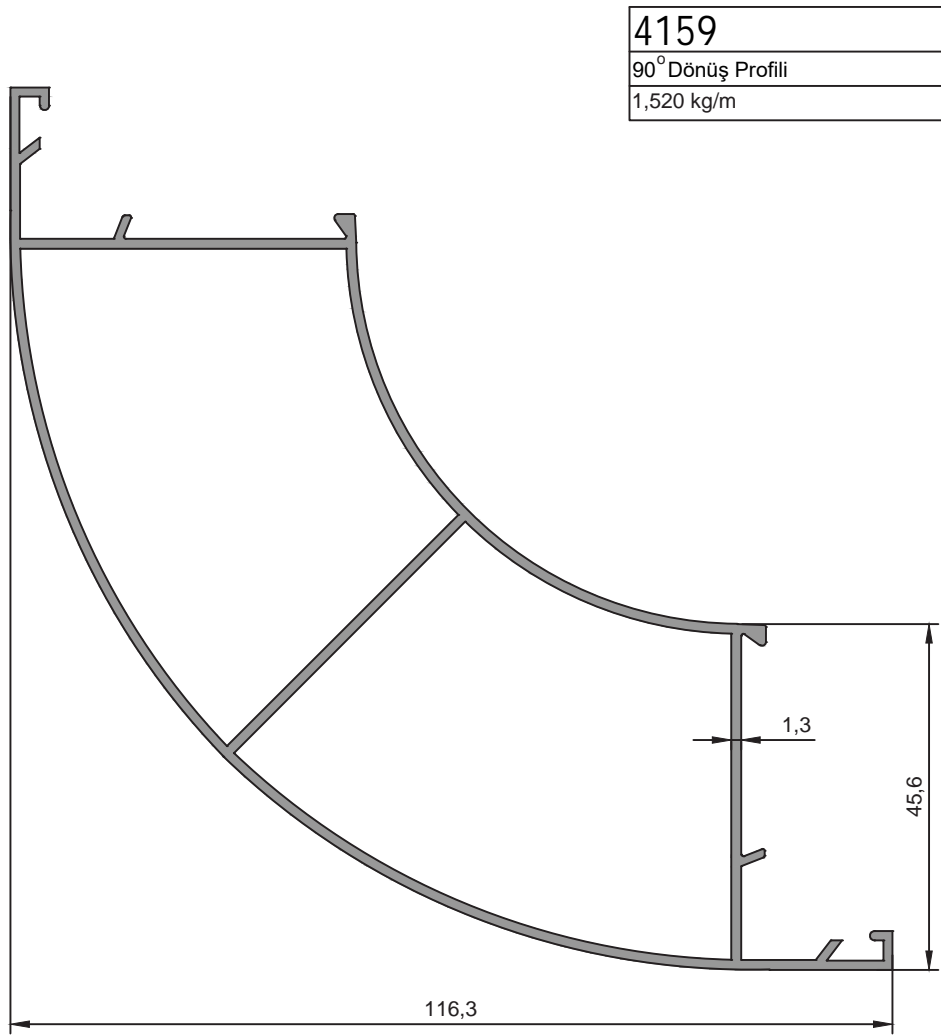

★ Yandaki profil birim ağırlıkları, bilgisayarda hesaplanmış teorik ağırlıklardır.

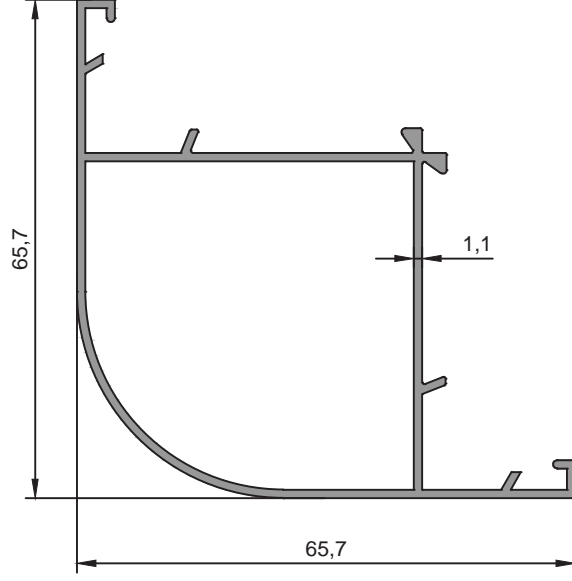

4160
90° Dönüş Profili
0,720 kg/m

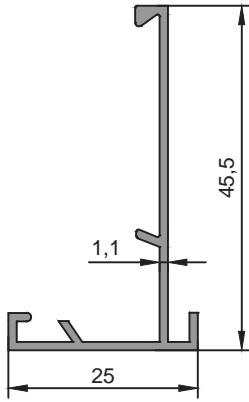

4161
Tırnak Adaptörü
0,272 kg/m

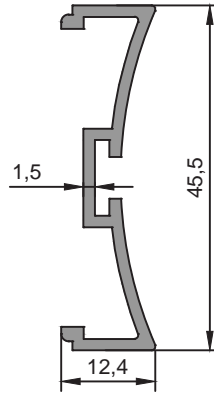

4162
Düz Seri Çarpma Kapı Adaptörü
0,341 kg/m

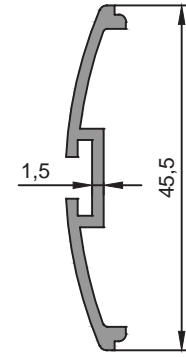

4163
Düz Seri Çarpma Kapı Adaptörü
0,260 kg/m

★ Yandaki profil birim ağırlıkları, bilgisayararda hesaplanmış teorik ağırlıklardır.

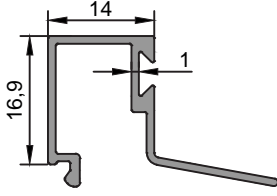

1750
Cam Çıtası
0,215 kg/m

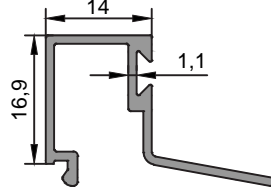

1090
Cam Çıtası
0,232 kg/m

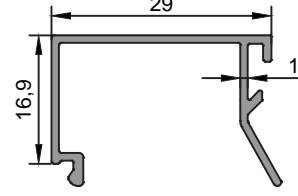

1749
Tek Cam Çıtası
0,215 kg/m

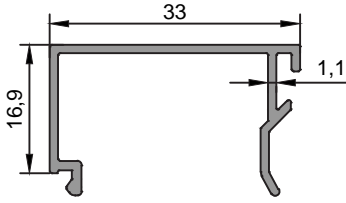

2413
Tek Cam Çıtası
0,243 kg/m

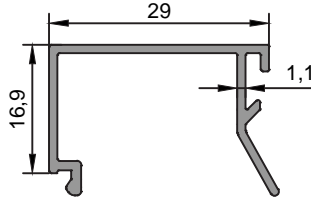

1088
Tek Cam Çıtası
0,232 kg/m

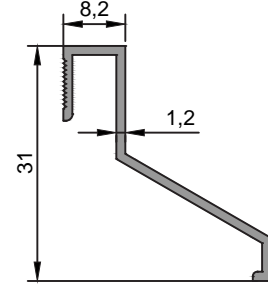

1094
Fugalı Te Bini
0,188 kg/m

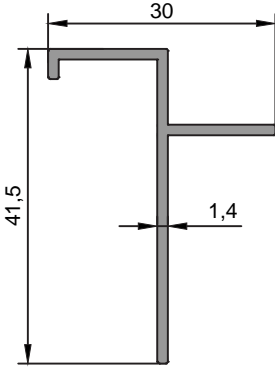

1404
Fugalı Te Bini
0,275 kg/m

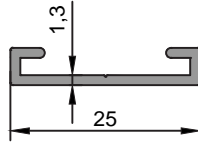

1175
İspanyolet Yuvası
0,135 kg/m

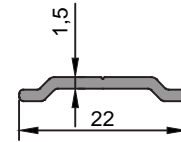

1176
İspanyolet Çubuğu
0,94 kg/m

ALDOKS SERİSİ

WINDOWS DOOR SYSTEM

★ Yandaki profil birim ağırlıkları, bilgisayararda hesaplanmış teorik ağırlıklardır.

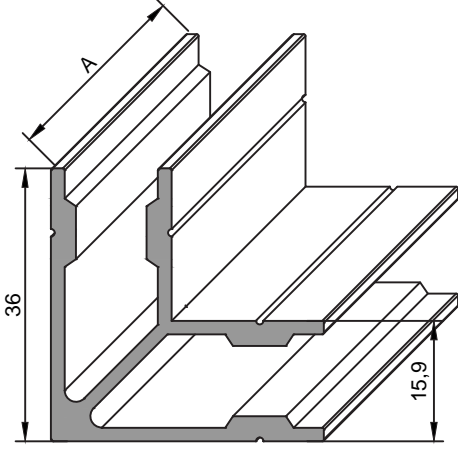

1333
Köşe Tako
0,772 kg/m

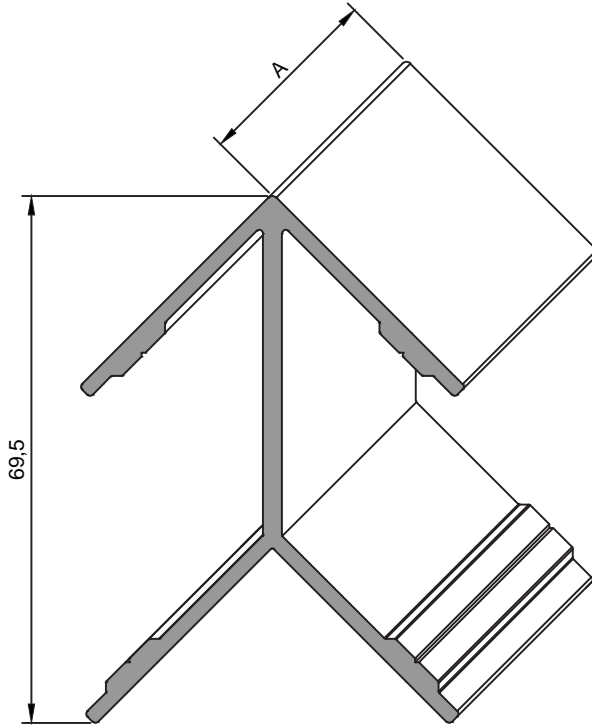

1099
Köşe Tako
1,122 kg/m

★ Yandaki profil birim ağırlıkları, bilgisayarda hesaplanmış teorik ağırlıklardır.

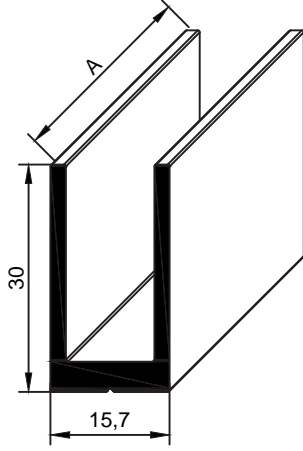

1406
Dar U Bağlantı Profili
0,451 kg/m

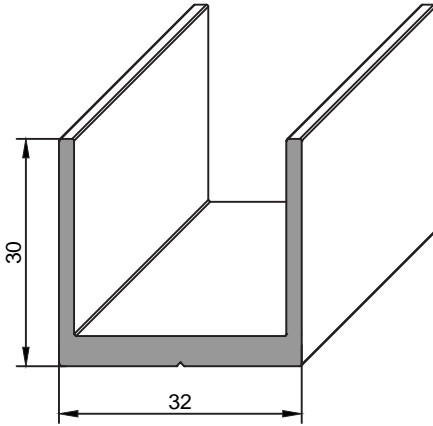

1330
Geniş U Bağlantı Profili
0,627 kg/m

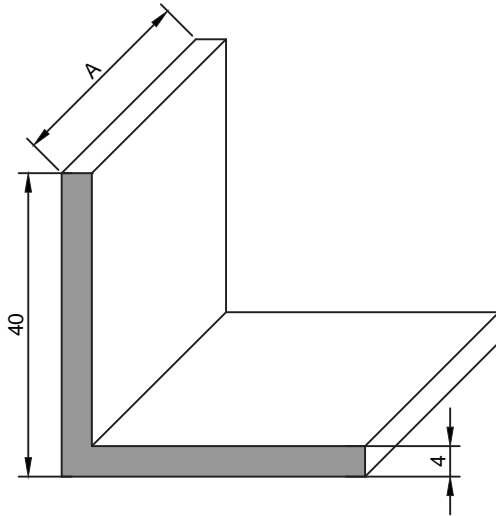

1114
Köşebent
0,823 kg/m



PROFILE CATALOGUE

AHŞAP KASA PROFİLLERİ

WOODEN DOOR FRAME PROFILES







★ Profil Ağırlıkları Teorik Olup Teslim Anındaki Ağırlık Geçerlidir

★ *Weight of profiles are theoretical, net weight will valid at the time of delivery.*

AHŞAP KASA PROFİLLERİ

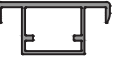
WOODEN DOOR FRAME PROFILES

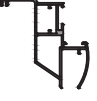
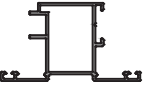
★ Yandaki profil birim ağırlıkları, bilgisayarda hesaplanmış teorik ağırlıklardır.

PROFİL KESİTİ	PROFİL KODU	PROFİL ADI	AĞIRLIK	ATALET MOMENTLERİ		SAYFA NO
				J_x (cm ⁴)	J_y (cm ⁴)	
	3270	İç Kasa Profili	1,300 kg/m	51,40	5,00	
	3271	Dış Kasa Profili	1,062 kg/m	35,41	7,02	
	3162	Lambiri	0,455 kg/m	4,02	0,57	
	3163	Kapı Kenarı Profili	0,497 kg/m	2,80	0,96	
	2941	Dış Kasa Profili	1,110 kg/m	39,23	9,79	
	2940	İç Kasa Profili	1,529 kg/m	43,08	9,80	
	3289	Çift Kanat Adaptörü	0,883 kg/m	11,08	7,83	
	2942	Alt Etek Profili	0,959 kg/m	10,64	2,25	
	2943	Kapı Profili	0,918 kg/m	10,23	2,71	

AHŞAP KASA PROFİLLERİ

WOODEN DOOR FRAME PROFILES

AKSESUAR KESİTİ	AKSESUAR KODU	AKSESUAR ADI	AĞIRLIK	PAKETLEME	SAYFA NO
	HL37	Kanal Dolgu Fiteli	107 gr/m	15 kg/ 140 m	
	HA32-30/1/2	10x19 mm Zamak Köşe	...	1 Ad/ Paket	
	HA32-30/2/2	10x24 mm Zamak Köşe	...	1 Ad/ Paket	
	HA32-26/5	Panel Menteşe	...	1 Ad/ Paket	
	HA-32-26/5-1	Kelebek Menteşe	...	1 Ad/ Paket	
	152RP45	Kapı Kiliti	...	1 Ad/ Paket	
	HA31-07/G63-1	Paslanmaz Yuvarlak Rozetli Sosis Kol	...	1 Ad/ Paket	
	HA31-07/G63	Paslanmaz Yuvarlak Rozetli Sosis Kol(WC İçin)	...	1 Ad/ Paket	
	HA39-04	Pervaz Köşesi L İnce Onbaşı	

★ Yandaki profil birim ağırlıkları, bilgisayarda hesaplanmış teorik ağırlıklardır.

AHŞAP KASA PROFİLLERİ

WOODEN DOOR FRAME PROFILES

★ Yandaki profil birim ağırlıkları, bilgisayarda hesaplanmış teorik ağırlıklardır.

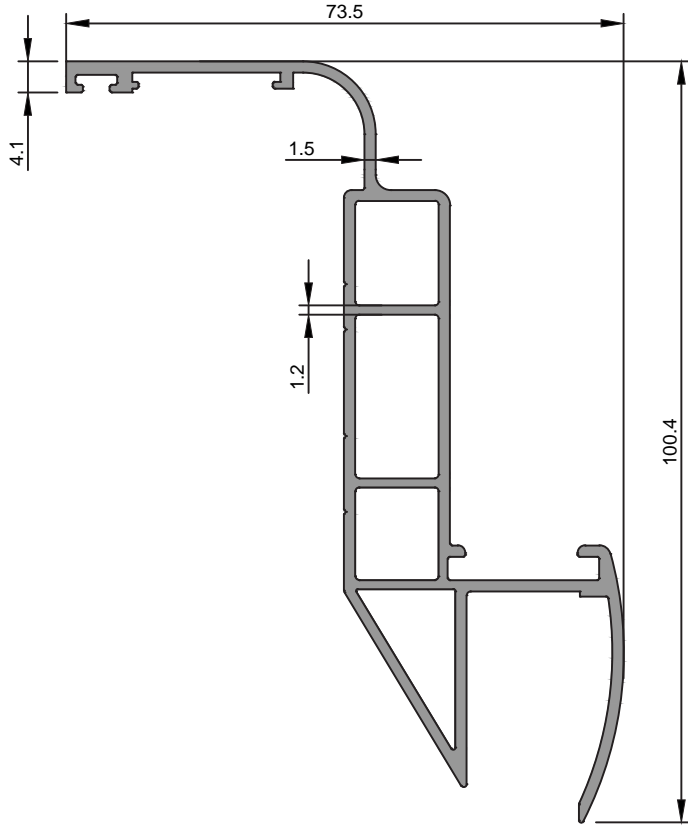

3270
İç Kasa
1,300 kg/m
$Jx=51,40 \text{ cm}^4$ $Jy=5,00 \text{ cm}^4$

AHŞAP KASA PROFİLLERİ

WOODEN DOOR FRAME PROFILES

★ Yandaki profil birim ağırlıkları, bilgisayararda hesaplanmış teorik ağırlıklardır.

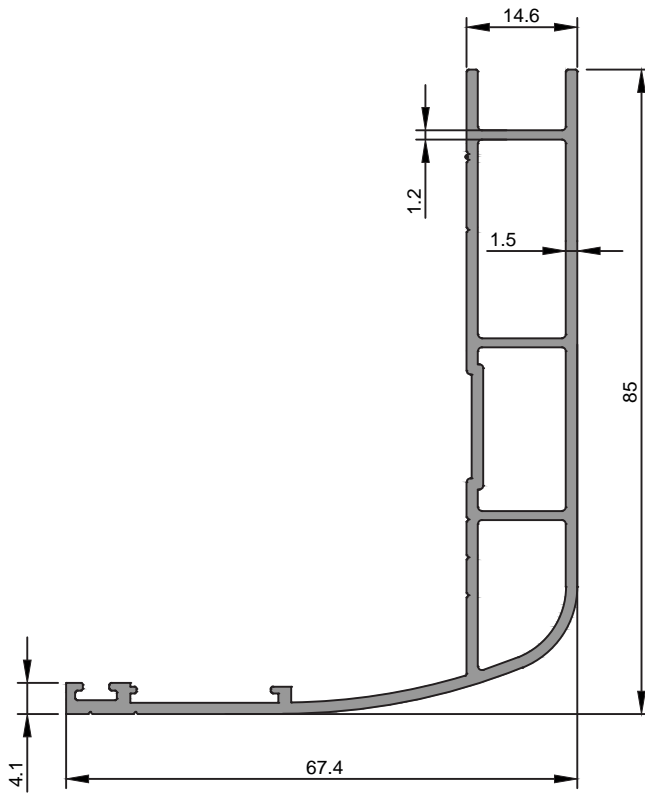

3271
Dış Kasa
1,062 kg/m
$J_x=35,41 \text{ cm}^4$ $J_y=7,02 \text{ cm}^4$

AHŞAP KASA PROFİLLERİ

WOODEN DOOR FRAME PROFILES

★ Yandaki profil birim ağırlıkları, bilgisayarla hesaplanmış teorik ağırlıklardır.

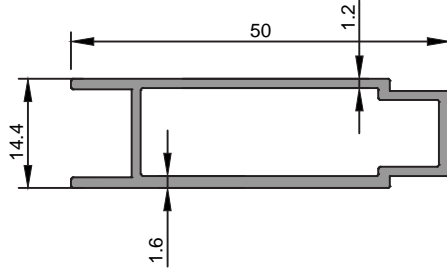

3162
Lambiri
0,455 kg/m
$J_x=4,02 \text{ cm}^4$ $J_y=0,57 \text{ cm}^4$

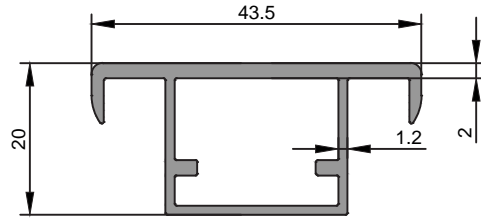

3163
Kapı Kenarı
0,497 kg/m
$J_x=2,80 \text{ cm}^4$ $J_y=0,96 \text{ cm}^4$

AHŞAP KASA PROFİLLERİ

WOODEN DOOR FRAME PROFILES

★ Yandaki profil birim ağırlıkları, bilgisayararda hesaplanmış teorik ağırlıklardır.

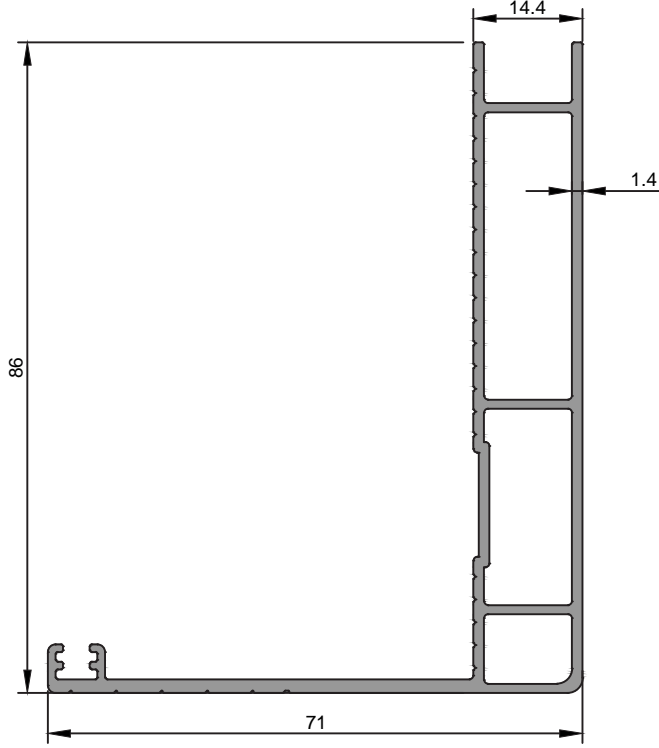

2941
Dış Kasa
1,110 kg/m
Jx=39,23 cm ⁴ Jy=9,79 cm ⁴

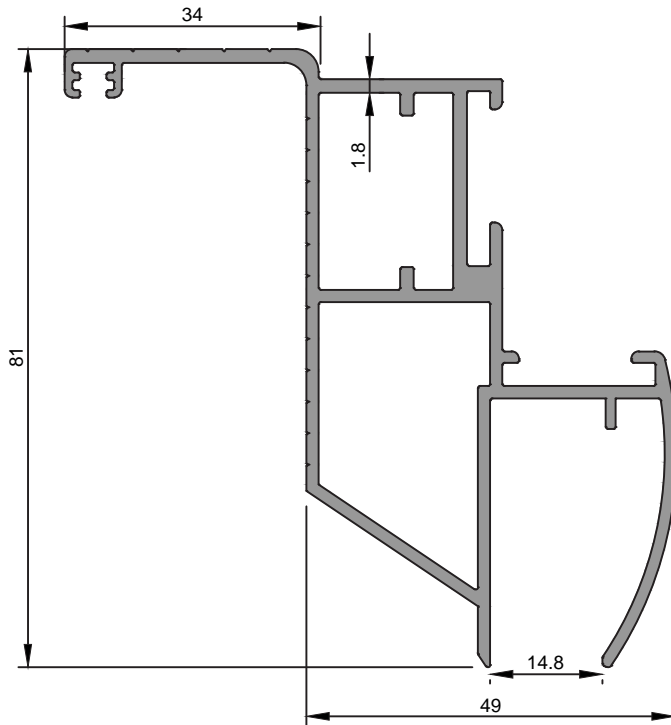

2940
İç Kasa
1,529 kg/m
Jx=43,08 cm ⁴ Jy=9,80 cm ⁴

AHŞAP KASA PROFİLLERİ

WOODEN DOOR FRAME PROFILES

★ Yandaki profil birim ağırlıkları, bilgisayarla hesaplanmış teorik ağırlıklardır.

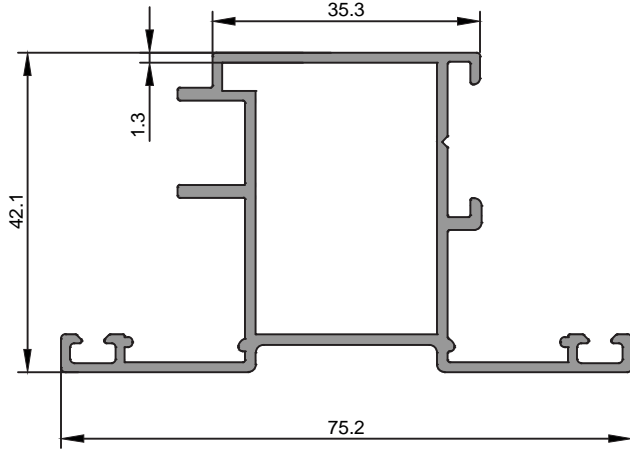

3289
Çift Kanat Adaptörü
0,883 kg/m
$Jx=11,08 \text{ cm}^4$ $Jy=7,83 \text{ cm}^4$

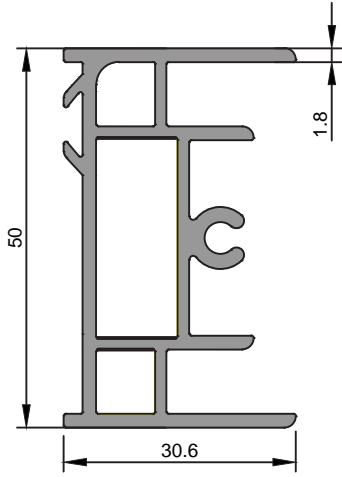

2942
Alt Etek
0,959 kg/m
$Jx=10,64 \text{ cm}^4$ $Jy=2,25 \text{ cm}^4$

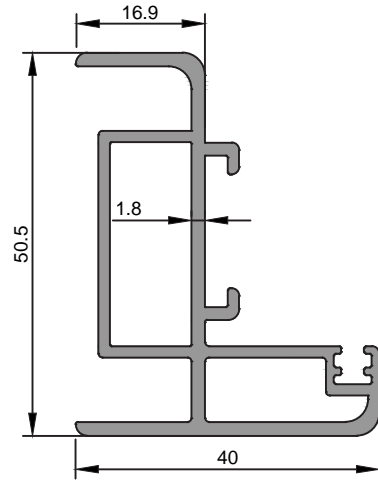

2943
Kapı Profili
0,918 kg/m
$Jx=10,23 \text{ cm}^4$ $Jy=2,71 \text{ cm}^4$

AHŞAP KASA PROFİLLERİ

WOODEN DOOR FRAME PROFILES

★ Yandaki profil birim ağırlıkları, bilgisayararda hesaplanmış teorik ağırlıklardır.

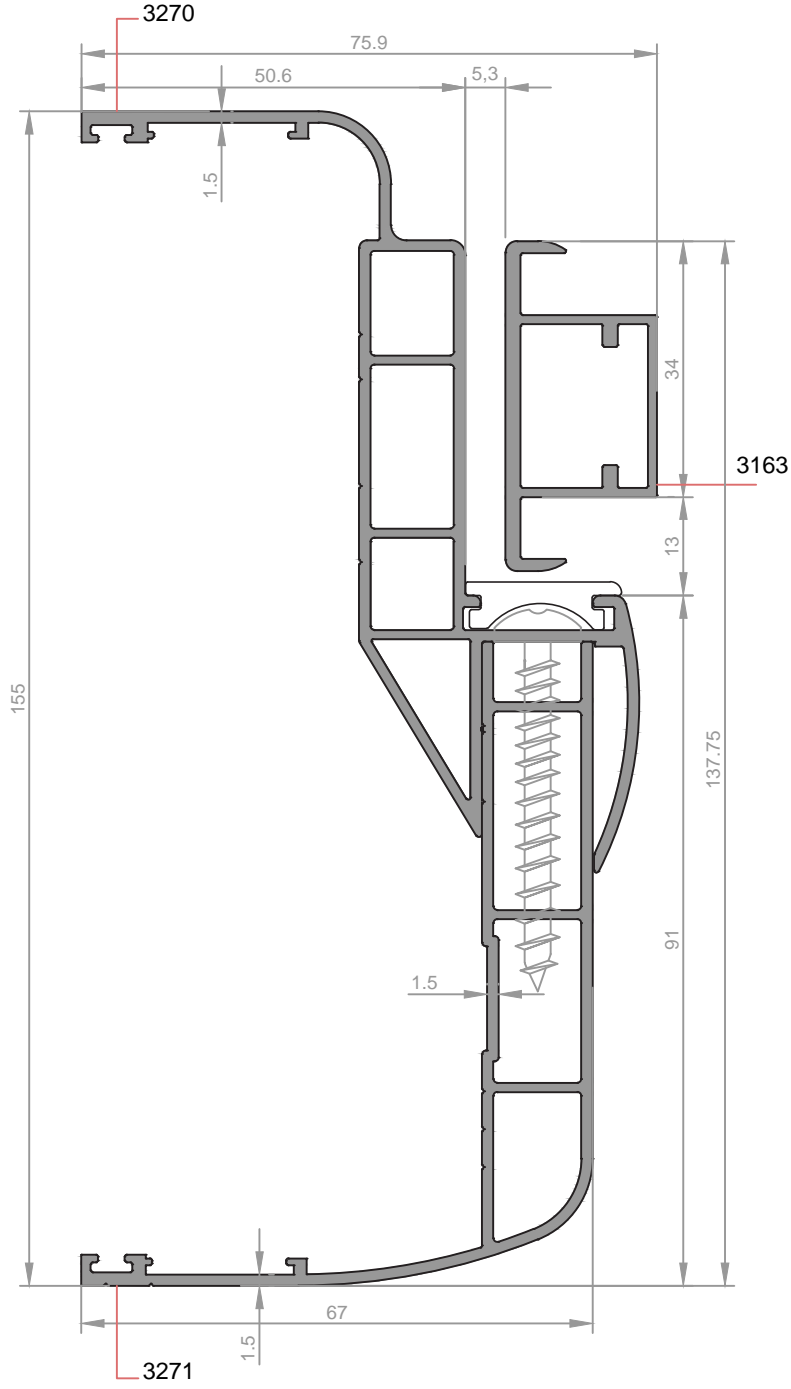

AHŞAP KASA PROFİLLERİ

WOODEN DOOR FRAME PROFILES

★ Yandaki profil birim ağırlıkları, bilgisayarda hesaplanmış teorik ağırlıklardır.

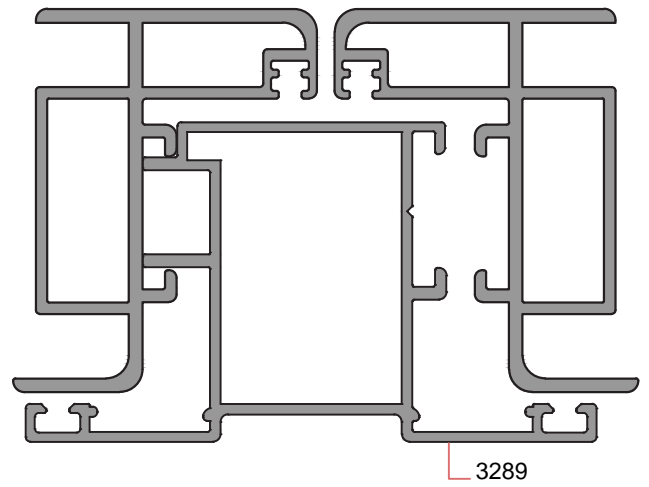
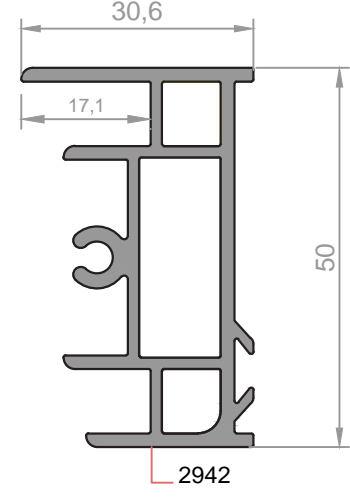
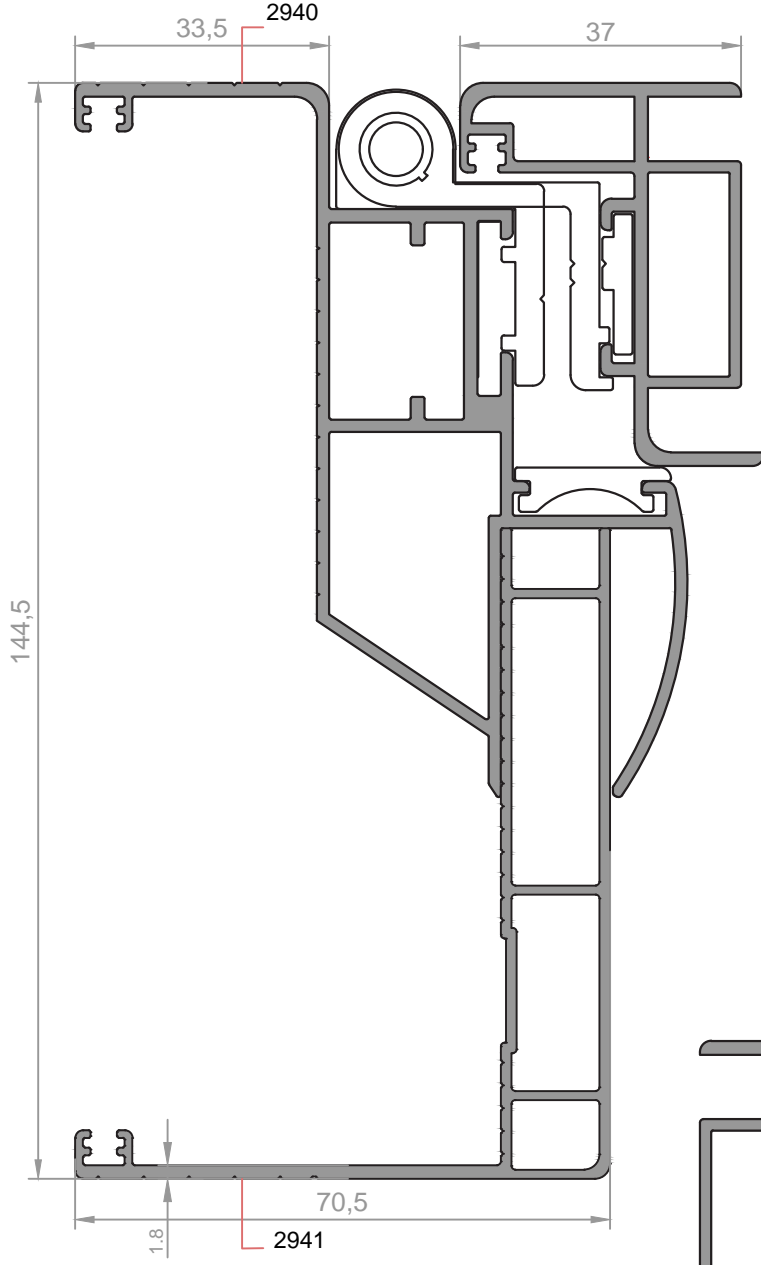

PROFİL KATALOĞU

ARA BÖLME PROFİLLERİ

PARTITION PROFILES









* Profil Ağırlıkları Teorik Olup Teslim Anındaki Ağırlık Geçerlidir

* *Weight of profiles are theoretical, net weight will valid at the time of delivery.*

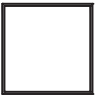
ARA BÖLME PROFİLLERİ

PARTITION PROFILES

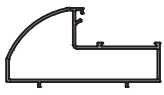
★ Yandaki profil birim ağırlıkları, bilgisayarda hesaplanmış teorik ağırlıklardır.

PROFİL KESİTİ	PROFİL KODU	PROFİL ADI	AĞIRLIK	ATALET MOMENTLERİ		SAYFA NO
				J_x (cm ⁴)	J_y (cm ⁴)	
	2924	Köşe Profili	1,949 kg/m	
	2923	Kasa Profili	1,208 kg/m	
	2939	Köşe Profili	1,691 kg/m	
	2922	Adaptör	0,810 kg/m	
	2921	Kapak Profili	0,196 kg/m	
	2944	Bağlantı Profili	0,670 kg/m	
	2925	Kapı Kasa Profili	1,297 kg/m	
	2920	Bağlantı Profili	0,503 kg/m	

ARA BÖLME PROFİLLERİ

PARTITION PROFILES

2924
Köşe Profili
1,949 kg/m

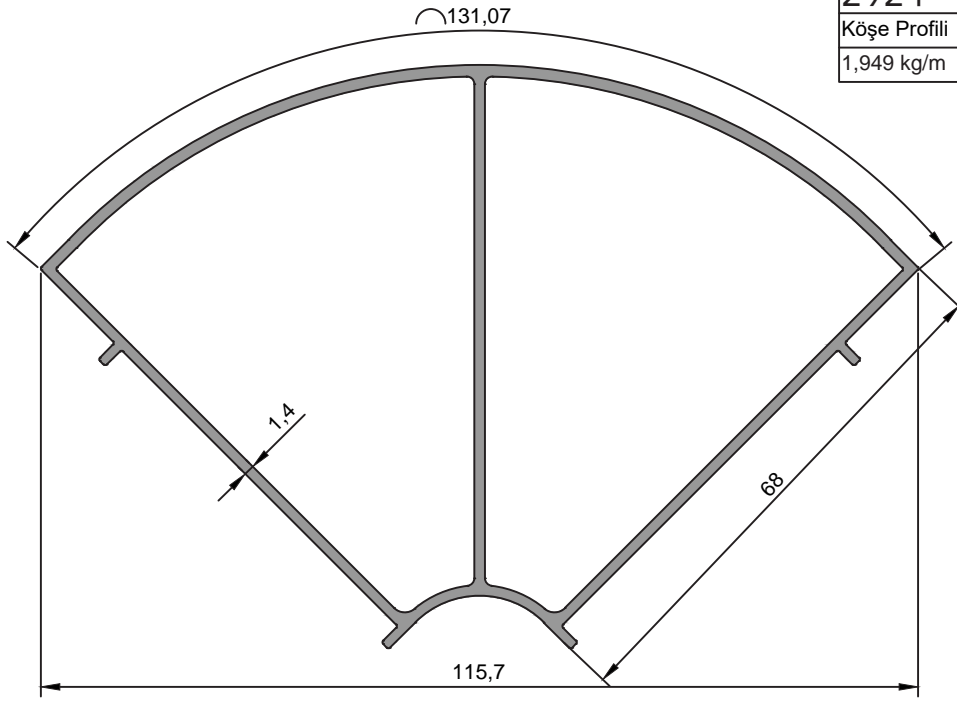

2923
Kasa Profili
1,208 kg/m

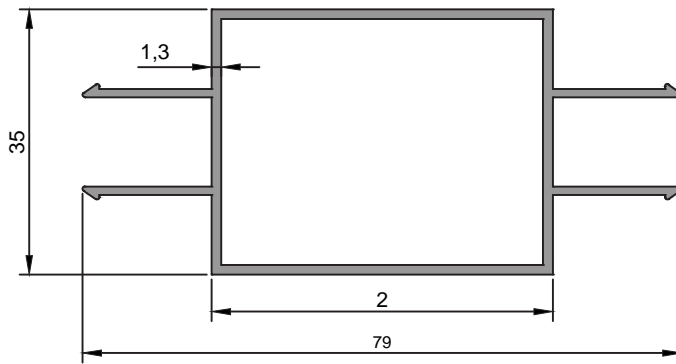

★ Yandaki profil birim ağırlıkları, bilgisayarda hesaplanmış teorik ağırlıklardır.

ARA BÖLME PROFİLLERİ

PARTITION PROFILES

★ Yandaki profil birim ağırlıkları, bilgisayarla hesaplanmış teorik ağırlıklardır.

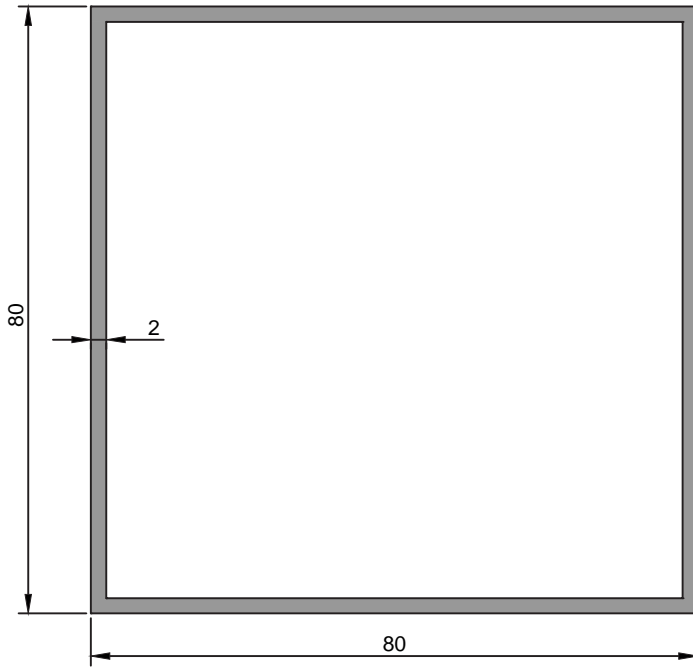

2939
Köşe Profili
1,691 kg/m

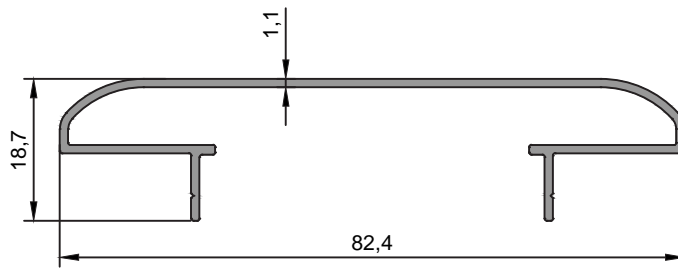

2922
Adaptör
0,810 kg/m

ARA BÖLME PROFİLLERİ

PARTITION PROFILES

★ Yandaki profil birim ağırlıkları, bilgisayarla hesaplanmış teorik ağırlıklardır.

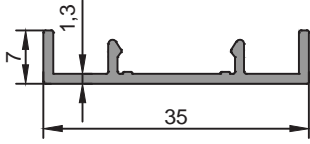

2921
Kapak Profili
0,196 kg/m



2944
Bağlantı Profili
0,670 kg/m

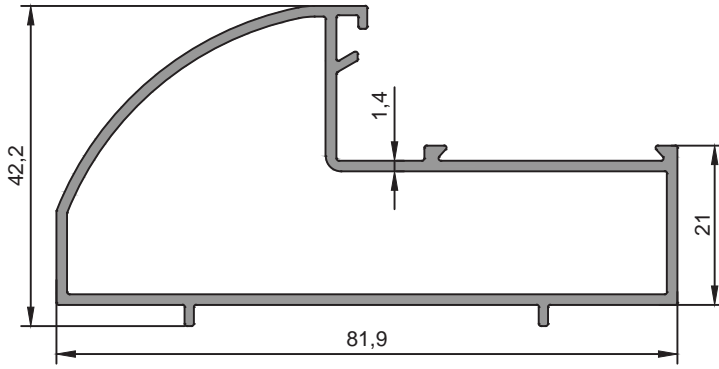

2925
Kapı Kasa Profili
1,297 kg/m

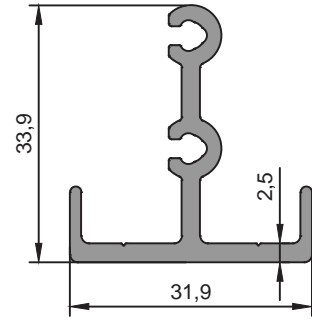

2920
Bağlantı Profili
0,503 kg/m

ARA BÖLME PROFİLLERİ

PARTITION PROFILES

★ Yandaki profil birim ağırlıkları, bilgisayarla hesaplanmış teorik ağırlıklardır.

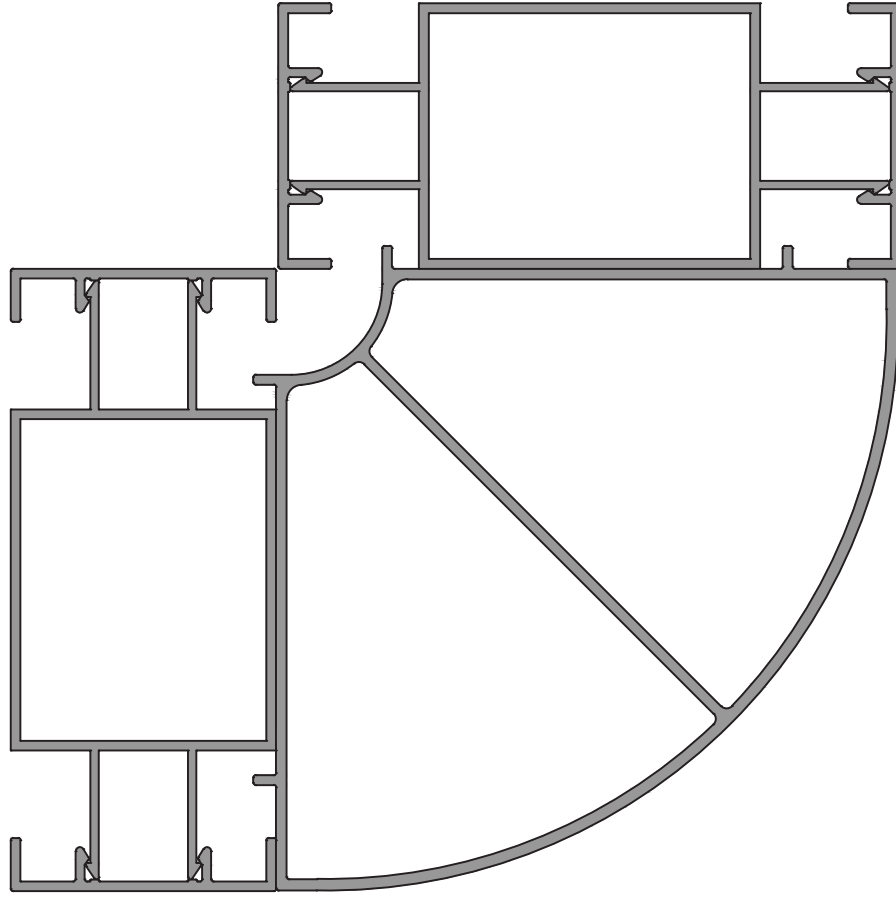

ARA BÖLME PROFİLLERİ

PARTITION PROFILES

★ Yandaki profil birim ağırlıkları, bilgisayarda hesaplanmış teorik ağırlıklardır.

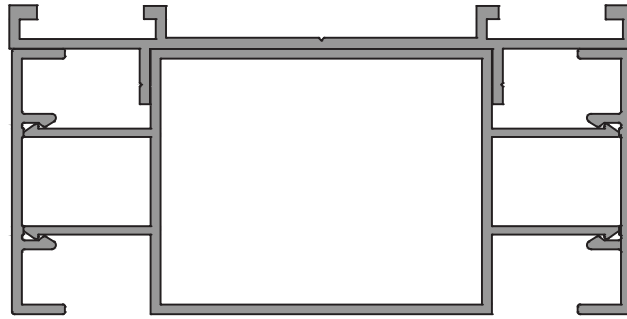
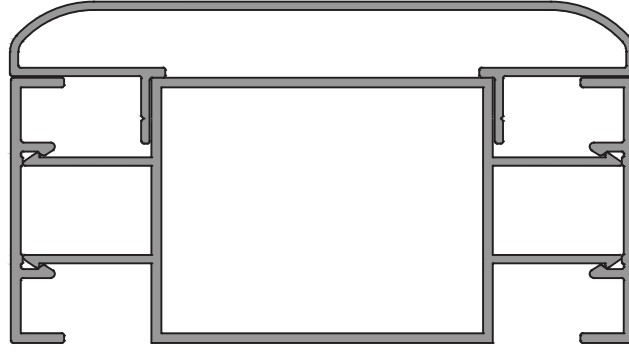

ARA BÖLME PROFİLLERİ

PARTITION PROFILES

★ Yandaki profil birim ağırlıkları, bilgisayarda hesaplanmış teorik ağırlıklardır.

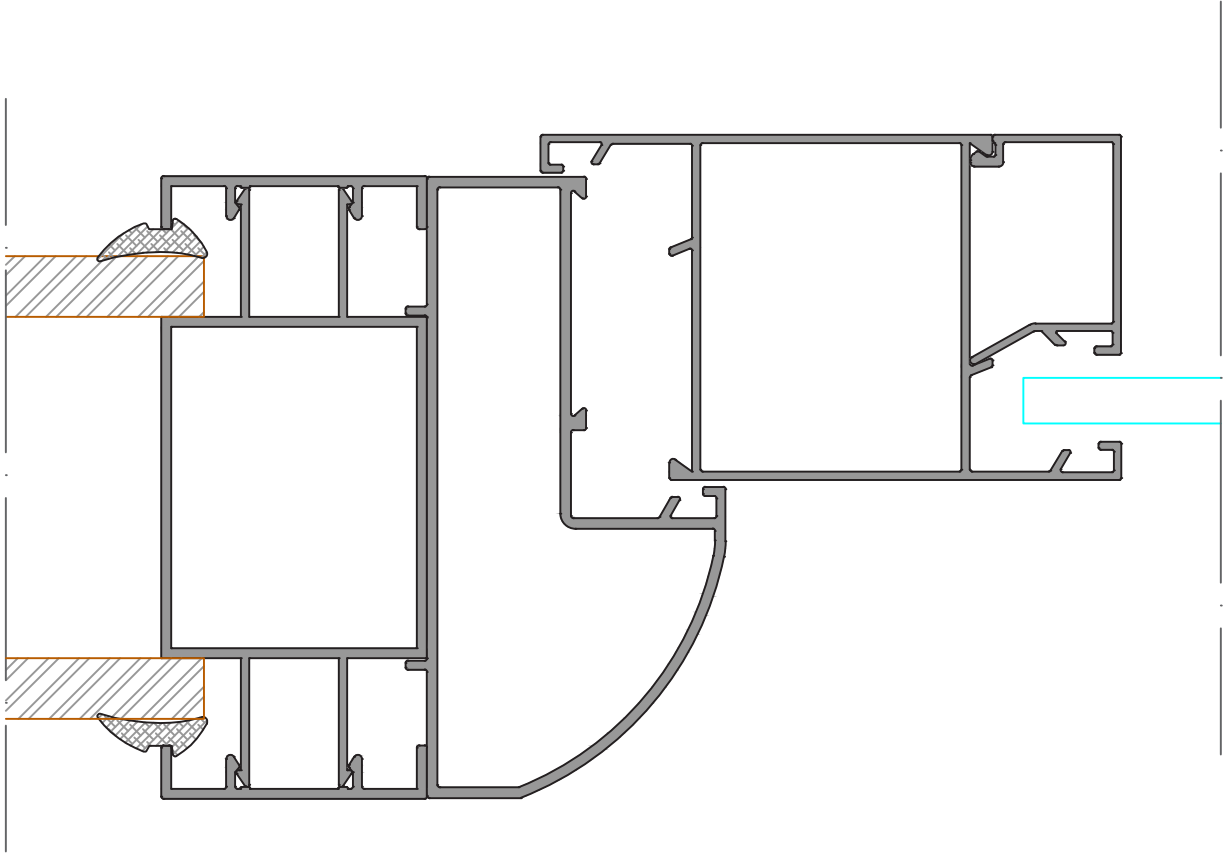

PROFİL KATALOĐU







HC60 SERİ

HC60 SERIE

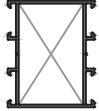
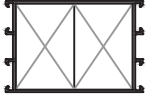
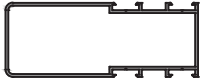
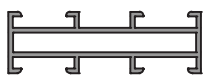
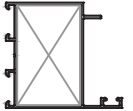
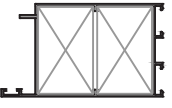
* Profil Ađırlıkları Teorik Olup Teslim Anındaki Ađırlık Geerlidir

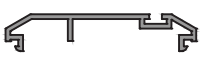
* *Weight of profiles are theoretical, net weight will valid at the time of delivery.*



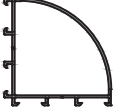
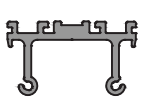

★ Yandaki profil birim ağırlıkları, bilgisayarda hesaplanmış teorik ağırlıklardır.

PROFİL KESİTİ	PROFİL KODU	PROFİL ADI	AĞIRLIK	ATALET MOMENTLERİ		SAYFA NO
				J_x (cm ⁴)	J_y (cm ⁴)	
	1117	Kasa ve Orta Kayıt	0,952 kg/m	17,56	11,37	
	2131	Kasa ve Orta Kayıt	1,410 kg/m	57,22	30,55	
	4149_1	Takviyeli Orta Kayıt	2,010 kg/m	146,67	30,73	
	4197	Dar Kasa ve Orta	0,761 kg/m	10,73	0,76	
	1118	Kanat	1,013 kg/m	21,51	13,49	
	4178	Geniş Kanat	1,492 kg/m	62,06	32,71	
	1132	Kasa Adaptörü	0,414 kg/m	6,72	0,61	
	2129	Çarpma Adaptörü	0,408 kg/m	5,82	0,14	
	4183	Çarpma Adaptörü	0,323 kg/m	4,39	0,12	
	2130	Çarpma Kapı Adaptörü	0,426 kg/m	7,29	0,20	
	4189	Etek Profili	1,812 kg/m	131,49	44,01	
	1130	90° Dönüş Profili	1,083 kg/m	25,33	15,42	
	4150	135° Dönüş Profili	1,173 kg/m	17,92	10,18	
	2367	Dik Bağlantı	1,274 kg/m			







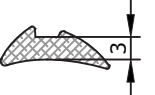
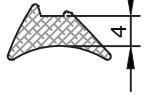
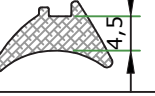
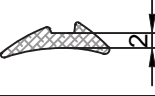

HC60 SERİ

HC60 SERIE

★ Yandaki profil birim ağırlıkları, bilgisayarla hesaplanmış teorik ağırlıklardır.

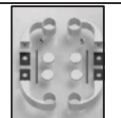
PROFİL KESİTİ	PROFİL KODU	PROFİL ADI	AĞIRLIK	ATALET MOMENTLERİ		SAYFA NO
				J_x (cm ⁴)	J_y (cm ⁴)	
	4180	Dik Bağlantı	0,800 kg/m			
	1089	Cam Çıtası	0,230 kg/m			
	1087	Cam Çıtası	0,211 kg/m			
	1838	Ek Profil	0,190 kg/m			

★ Yandaki profil birim ağırlıkları, bilgisayarda hesaplanmış teorik ağırlıklardır.

AKSESUAR KESİTİ	AKSESUAR KODU	AKSESUAR ADI	AĞIRLIK	PAKETLEME	SAYFA NO
	HL04	İç Cam Fitili - 3 mm	60 gr/m	15 kg/ 250 m	
	HL07	İç Cam Fitili - 4 mm	63 gr/m	15 kg/ 238 m	
	HL02	İç Cam Fitili - 4.5 mm	85 gr/m	15 kg/ 175 m	
	HL31	İç Cam Fitili - 2 mm	39 gr/m	15 kg/ 375 m	
	HA57-C60	KaucukPlastik		100 mt/ 1 Paket	
	HA31-02/09-1	Tek Büküm Oval Yale Kol (Paslanmaz)		1 Takım	
	HA31-11	Boru Kol		1 Takım	
	HA31-01	Yaylı Sosis Kol		1 Takım	
	HA31-09/13	Yaylı Dar Aynalı Sosis Kol		1 Takım	
	HA31-07/2Y	Yaylı Düz Rozetli Sosis Kol		1 Takım	
	HA31-24/20	Akbank 40'luk Kol Aparatı		1 Takım	
	HA31-24/2H	Akbank Havuzlu Kol Aparatı		1 Takım	
	HA34-01/4/5	62 mm Barel		1 Adet	
	HA33-10	Savio Uzun Sürgü		1 Adet	

AKSESUAR KESİTİ	AKSESUAR KODU	AKSESUAR ADI	AĞIRLIK	PAKETLEME	SAYFA NO
	HA33-13	Savio Kısa Sürgü		200 Ad/paket	
	HA34-04/1-N	Dilli Kilit (153-25)		30 Ad/paket	
	HA34-02/1N	Makaralı Kilit (155-25)		30 Ad/paket	
	HA33-06/1/3	C60 Dilli Kilit Karşılığı		400 Ad/paket	
	HA33-06/02/3	C60 Makaralı Kilit Karşılığı		400 Ad/paket	
	HA33-06/1/2-4	Elektrikli Kilit Karşılığı		400 Ad/paket	
	HA33-06/03	C60 Kilit Altı		400 Ad/paket	
	TS 71	Kapı Hidroliği			
	HA33-04/2	Kapı Altı Fırçası		100 Ad/paket	
	HA33-04/3	Y Kapı Alt Fırçası		100 Ad/paket	
	HA33-04/2	Y Kapı Alt Fırçası		100 Ad/paket	

★ Yandaki profil ağırlıkları, bilgisayarda hesaplanmış teorik ağırlıklardır.

★ Yandaki profil birim ağırlıkları, bilgisayararda hesaplanmış teorik ağırlıklardır.

AKSESUAR KESİTİ	AKSESUAR KODU	AKSESUAR ADI	AĞIRLIK	PAKETLEME	SAYFA NO
	SDKM-45-075	Düz Kapazlama Mentеше		10 Ad/paket	
	SDKM-57-076	Düz Kapazlama Mentеше		10 Ad/paket	
	HA32-28/5	C60 Orta Kayıt Bağlantı		500 Ad/paket	
	HA32-31/1	Boyunlu Eksenel Kol Tek Dilli		1 Ad/paket	
	HA32-33/1	Avrupa Karşılık Zamak Ak 315		500 Ad/paket	
	HA32-23	C60 Mentеше İkili		50 Ad/paket	
	HA32-22/11	Oval C60 Mentеше		50 Ad/paket	
	HA32-17/2	C60 Baba Mentеше		5x20 Ad/paket	

★ Yandaki profil birim ağırlıkları, bilgisayarla hesaplanmış teorik ağırlıklardır.

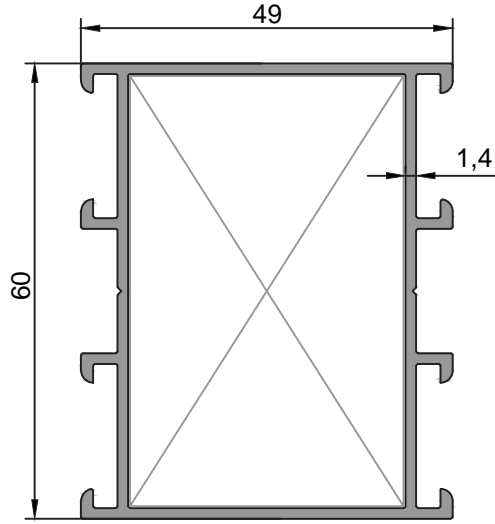

1117
Kasa ve Orta Kayıt
0,952 kg/m
$J_x=17,56 \text{ cm}^4$ $J_y=11,37 \text{ cm}^4$

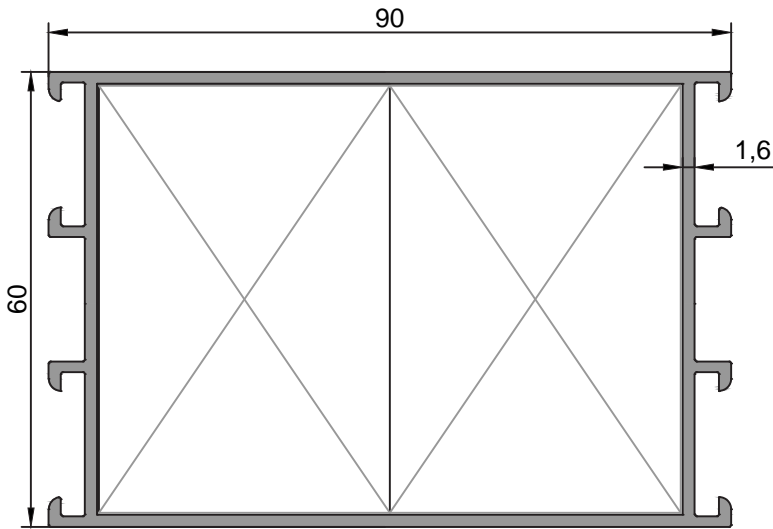

2131
Kasa ve Orta Kayıt
1,410 kg/m
$J_x=57,22 \text{ cm}^4$ $J_y=30,55 \text{ cm}^4$

★ Yandaki profil birim ağırlıkları, bilgisayarla hesaplanmış teorik ağırlıklardır.

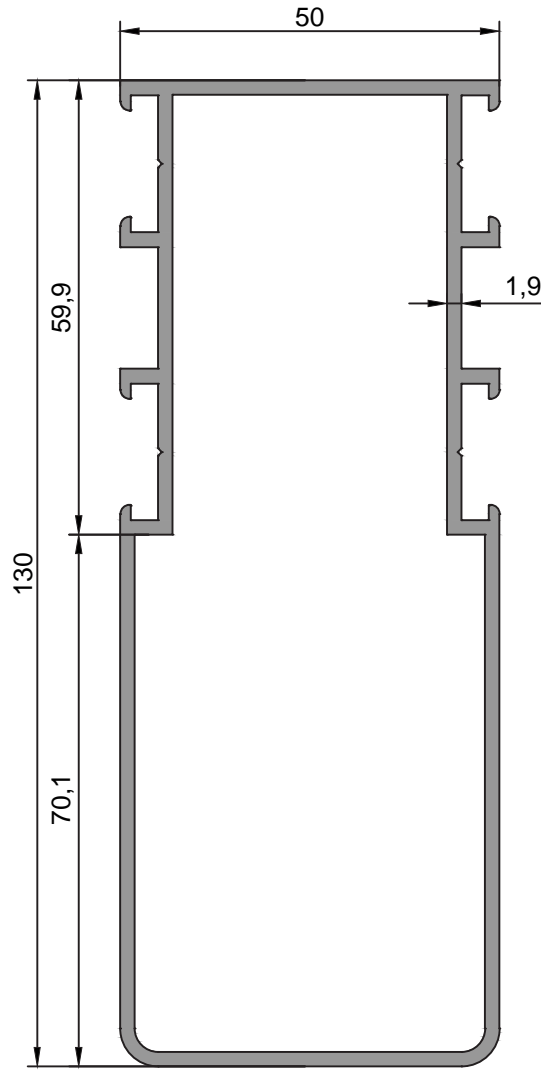

4149_1
Takviyeli Orta Kayıt
2,010 kg/m
$J_x=146,67 \text{ cm}^4$ $J_y=30,73 \text{ cm}^4$

★ Yandaki profil birim ağırlıkları, bilgisayarla hesaplanmış teorik ağırlıklardır.

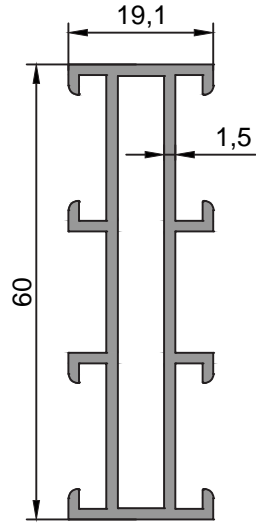

4197
Dar Kasa ve Orta
0,761 kg/m
$J_x=10,73 \text{ cm}^4$ $J_y=0,76 \text{ cm}^4$

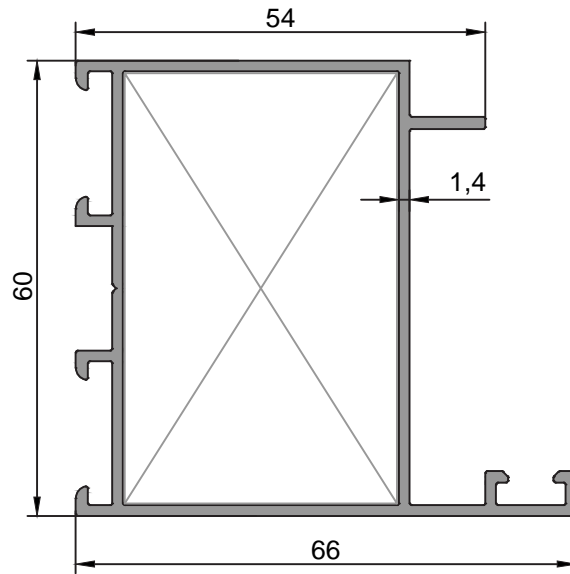

1118
Kanat
1,013 kg/m
$J_x=21,51 \text{ cm}^4$ $J_y=13,49 \text{ cm}^4$

HC60 SERİ

HC60 SERIE

★ Yandaki profil birim ağırlıkları, bilgisayarla hesaplanmış teorik ağırlıklardır.

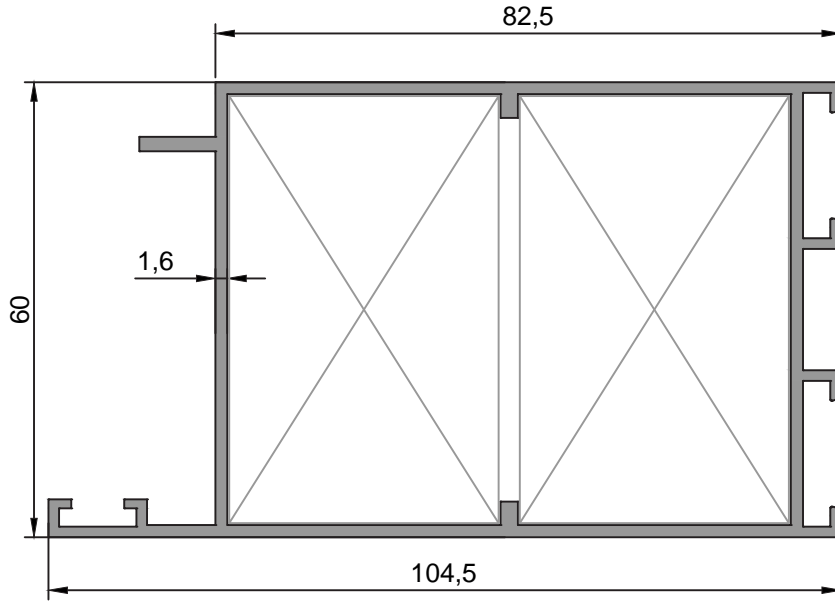

4178
Geniş Kanat
1,492 kg/m
Jx=62,06 cm ⁴ Jy=32,71 cm ⁴

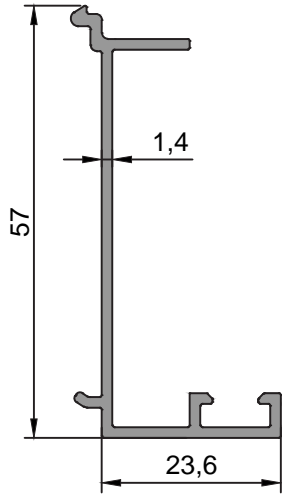

1132
Kasa Adaptörü
0,414 kg/m
Jx=6,72 cm ⁴ Jy=0,61 cm ⁴

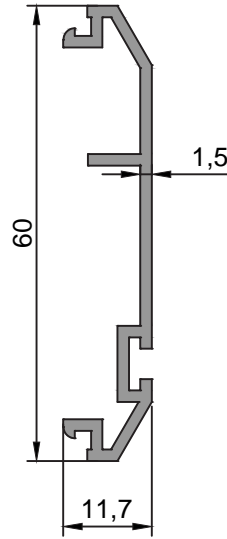

2129
Çarpma Adaptörü
0,408 kg/m
Jx=5,82 cm ⁴ Jy=0,14 cm ⁴

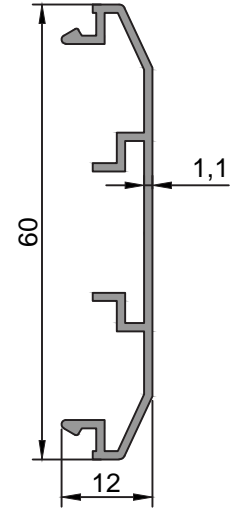

4183
Çarpma Adaptörü
0,323 kg/m
Jx=4,39 cm ⁴ Jy=0,12 cm ⁴

HC60 SERİ

HC60 SERIE

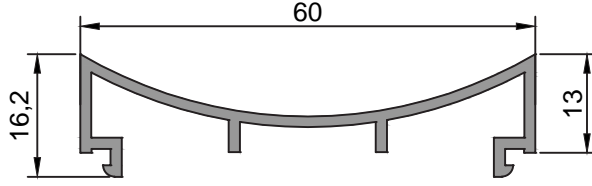

2130
Çarpma Kapı Adaptörü
0,426 kg/m
Jx=7,29 cm ⁴ Jy=0,20 cm ⁴

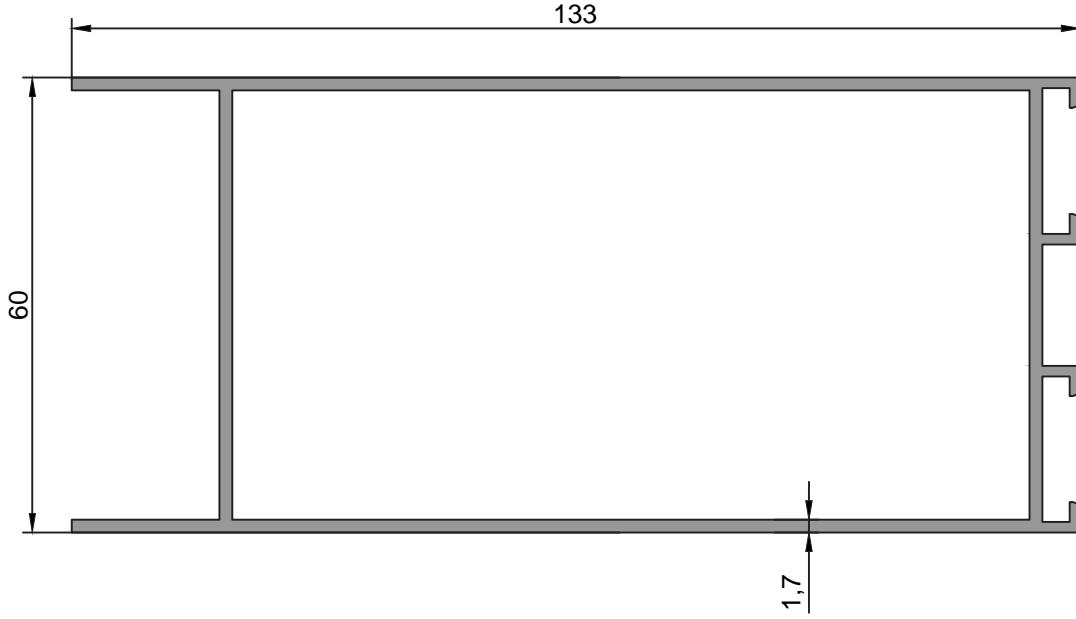

4189
Etek Profili
1,812 kg/m
Jx=131,49 cm ⁴ Jy=44,01 cm ⁴

★ Yandaki profil birim ağırlıkları, bilgisayararda hesaplanmış teorik ağırlıklardır.

HC60 SERİ

HC60 SERIE

★ Yandaki profil birim ağırlıkları, bilgisayarla hesaplanmış teorik ağırlıklardır.

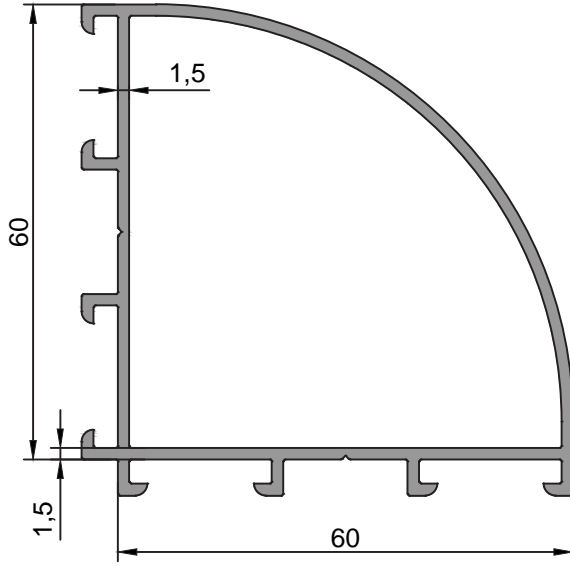

1130
90°Dönüş Profili
1,083 kg/m
$J_x=25,33 \text{ cm}^4$ $J_y=15,42 \text{ cm}^4$

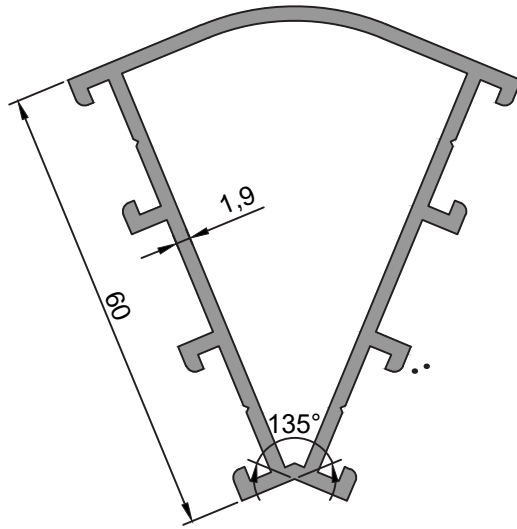

4150
135° Dönüş Profili
1,173 kg/m
$J_x=17,92 \text{ cm}^4$ $J_y=10,18 \text{ cm}^4$

★ Yandaki profil birim ağırlıkları, bilgisayarda hesaplanmış teorik ağırlıklardır.

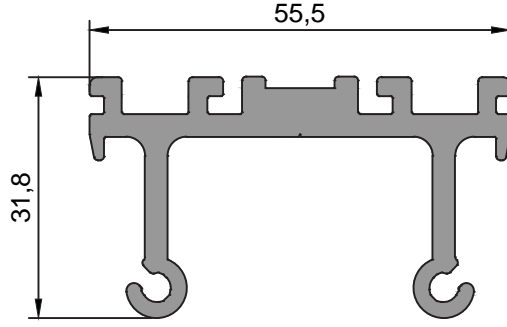

2367
Dik Bağlantı
1,274 kg/m

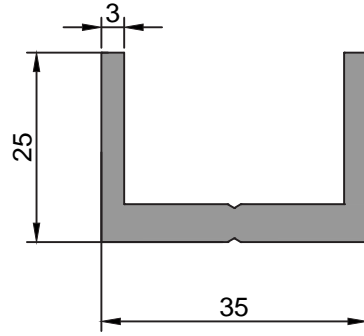

4180
Dik Bağlantı
0,800 kg/m

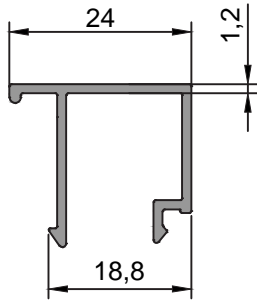

1089
Cam Çıtası
0,230 kg/m

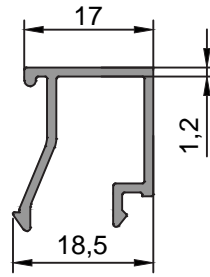

1087
Cam Çıtası
0,211 kg/m

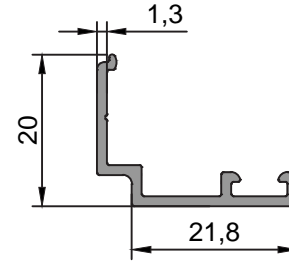

1838
Ek Profil
0,190 kg/m

★ Yandaki profil birim ağırlıkları, bilgisayararda hesaplanmış teorik ağırlıklardır.

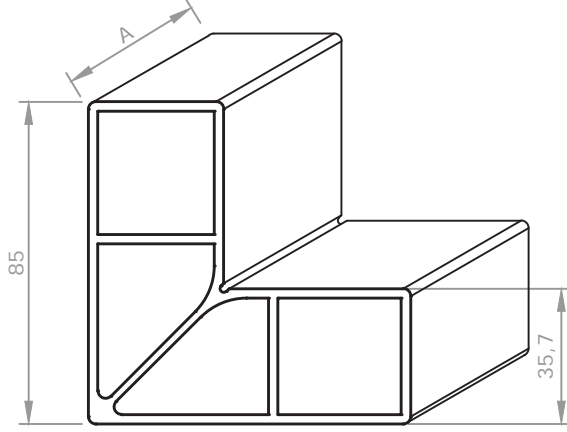

K4507
Köşe Takozu
2,930 kg/m

Aksesuar Kodu	Profil Kodu	Kesim Ölçüsü A(mm)
K4507 563	4178	56.3

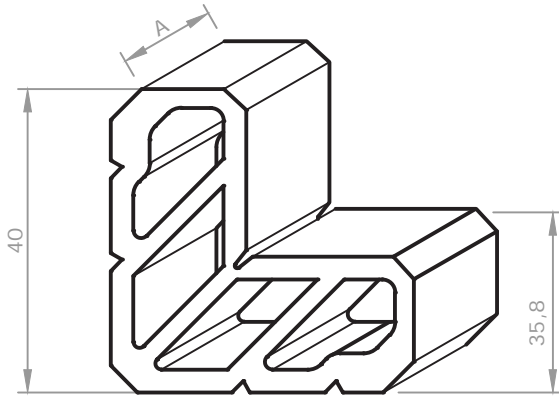

K3272
Köşe Takozu
6,230 kg/m

Aksesuar Kodu	Profil Kodu	Kesim Ölçüsü A(mm)
K3272 567	1117	56.7
K3272 563	2131	56.3
K3272 567	1118	56.7

PENCERE UYGULAMA TİPLERİ

★ Yandaki profil birim ağırlıkları, bilgisayarla hesaplanmış teorik ağırlıklardır.

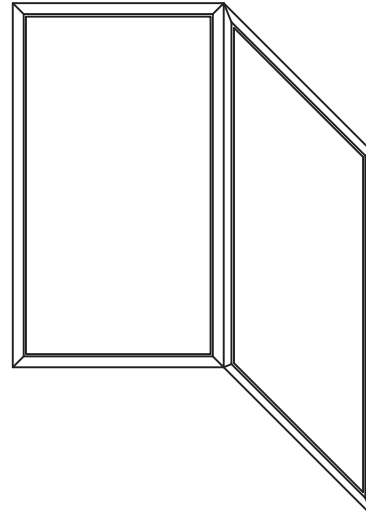
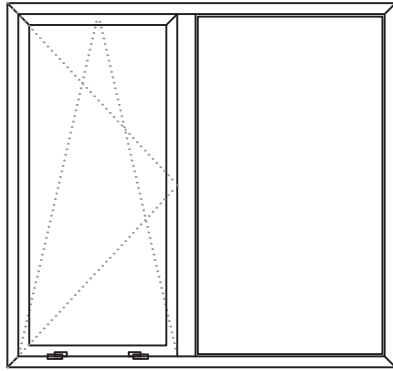
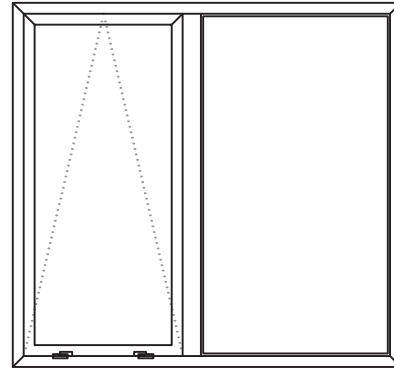
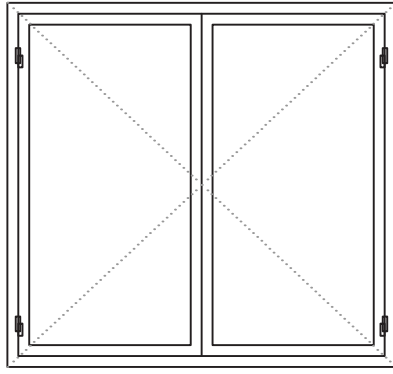

DETAY-1
ÖLÇEK:1/1

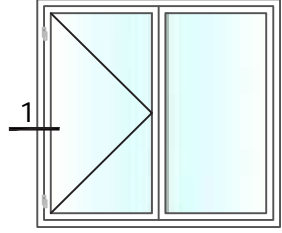

★ Yandaki profil birim ağırlıkları, bilgisayarla hesaplanmış teorik ağırlıklardır.

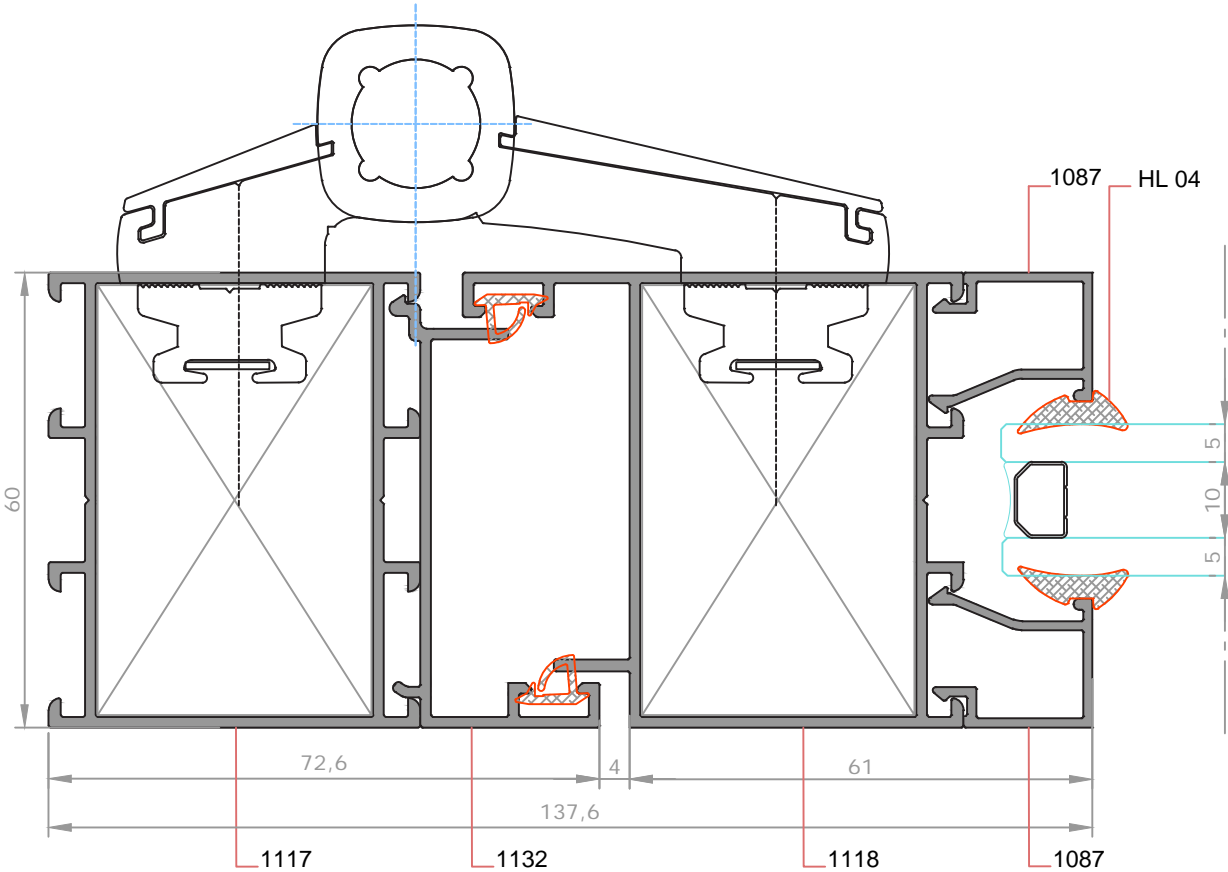

DETAY-2
ÖLÇEK:1/1

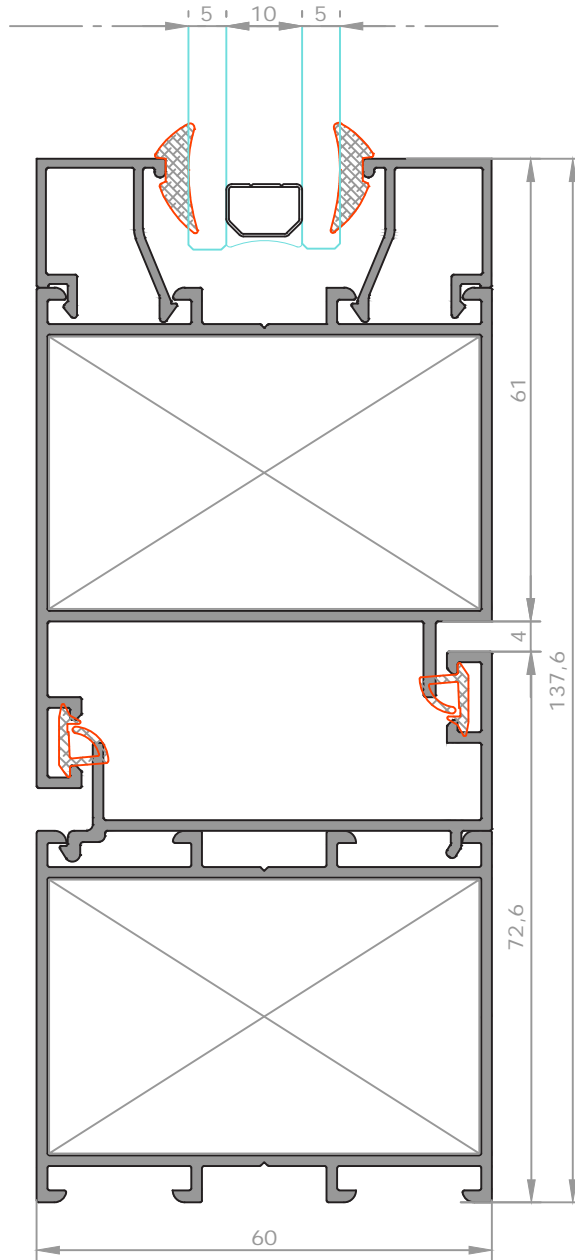
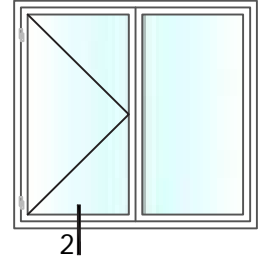

★ Yandaki profil birim ağırlıkları, bilgisayararda hesaplanmış teorik ağırlıklardır.

DETAY-3
ÖLÇEK:1/1

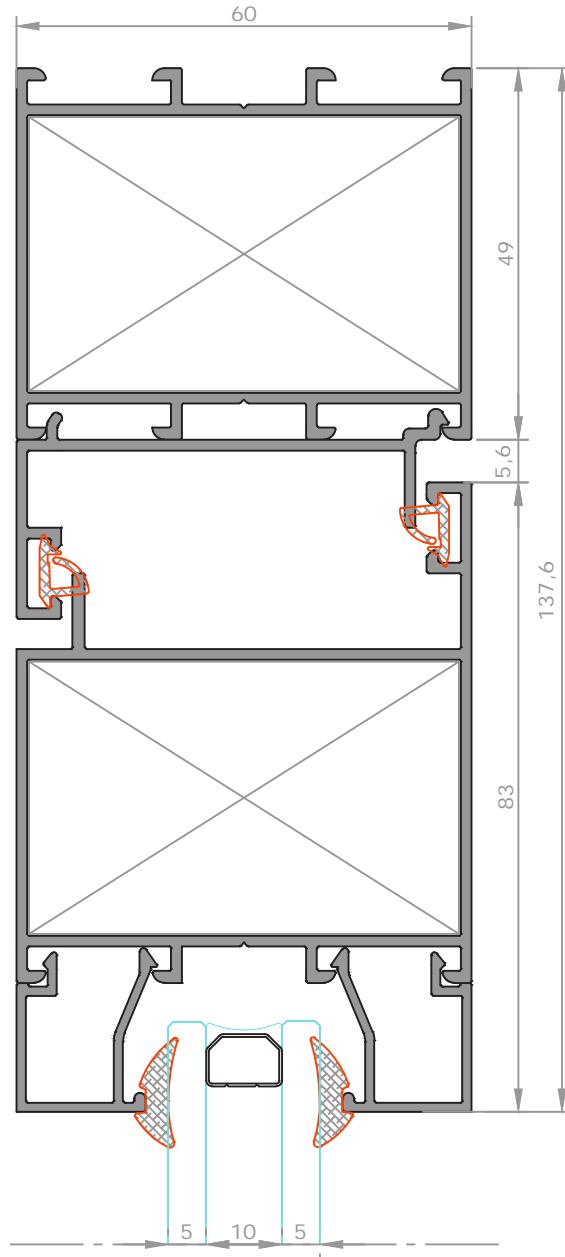
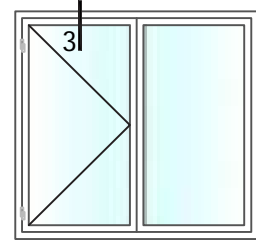

★ Yandaki profil birim ağırlıkları, bilgisayarla hesaplanmış teorik ağırlıklardır.

DETAY-4
ÖLÇEK:1/1

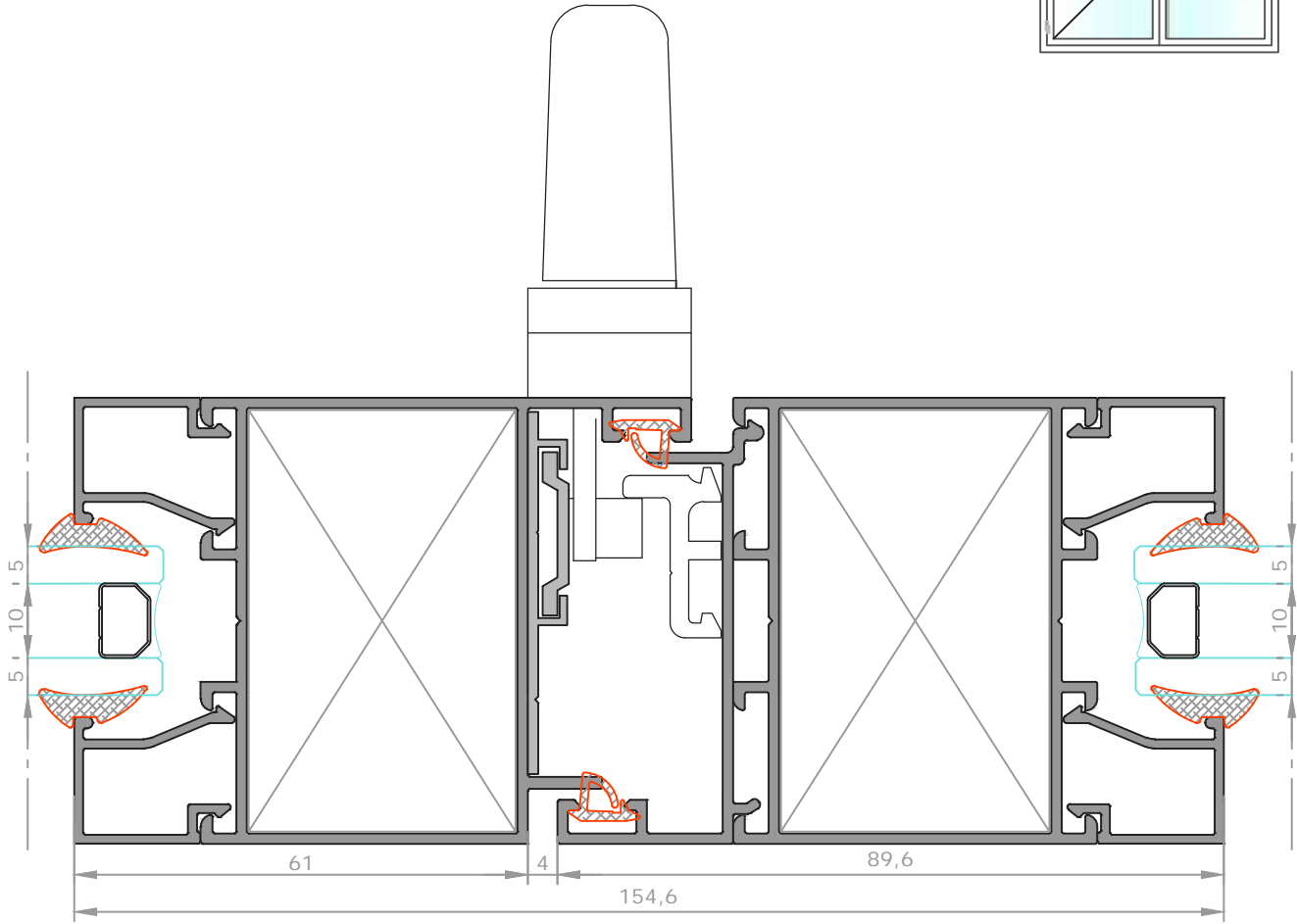
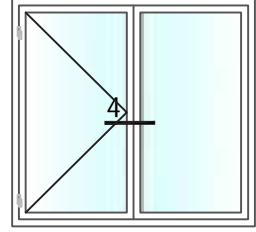

★ Yandaki profil birim ağırlıkları, bilgisayarda hesaplanmış teorik ağırlıklardır.

DETAY-5
ÖLÇEK:1/1

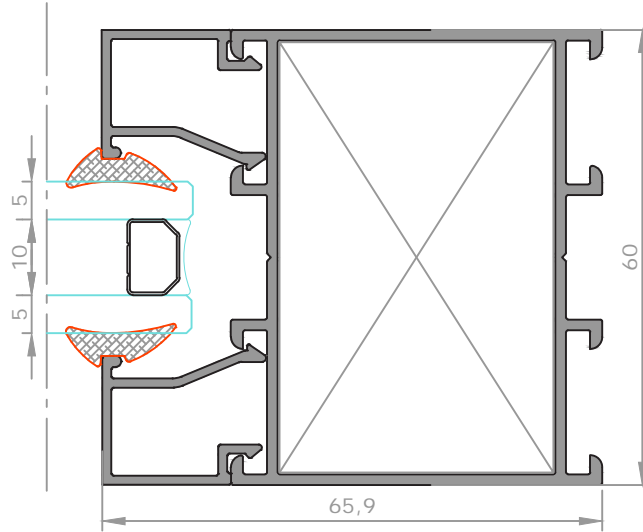
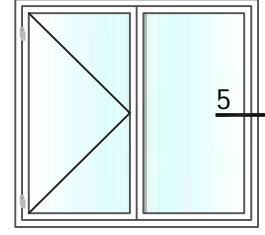

★ Yandaki profil birim ağırlıkları, bilgisayarda hesaplanmış teorik ağırlıklardır.

DETAY- 1a
ÖLÇEK:1/1

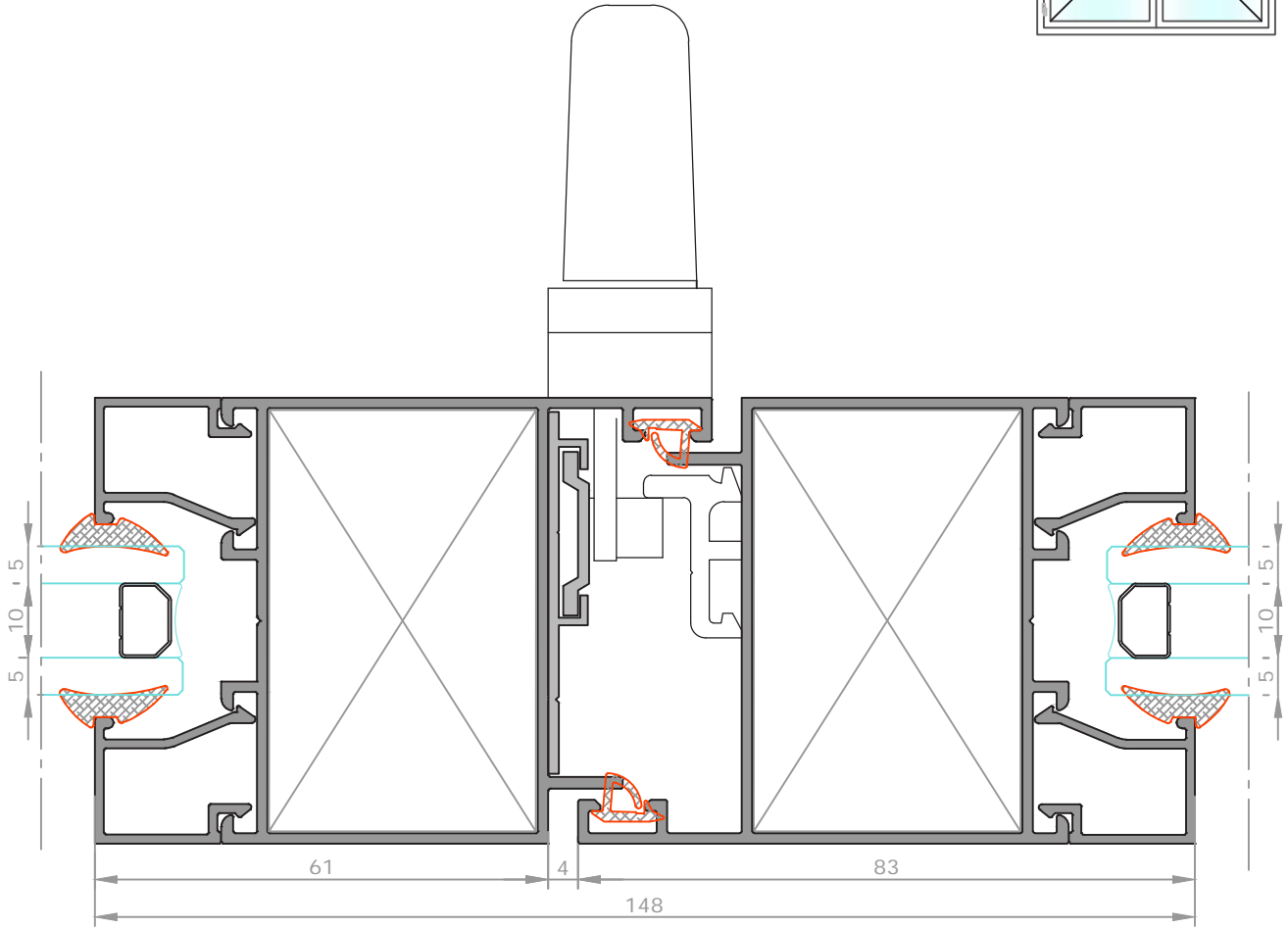
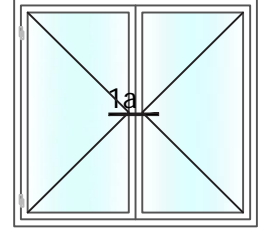

★ Yandaki profil ağırlıkları, bilgisayarda hesaplanmış teorik ağırlıklardır.

KAPI UYGULAMA TİPLERİ

★ Yandaki profil birim ağırlıkları, bilgisayarla hesaplanmış teorik ağırlıklardır.

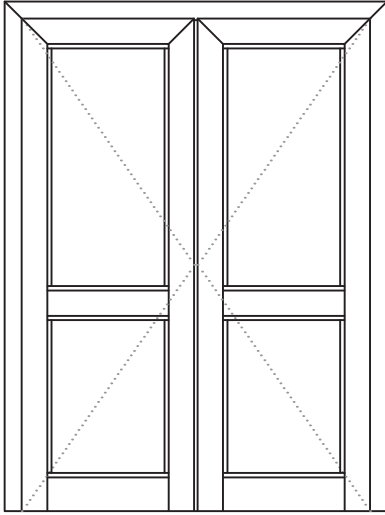

İçe Açılır Kapı

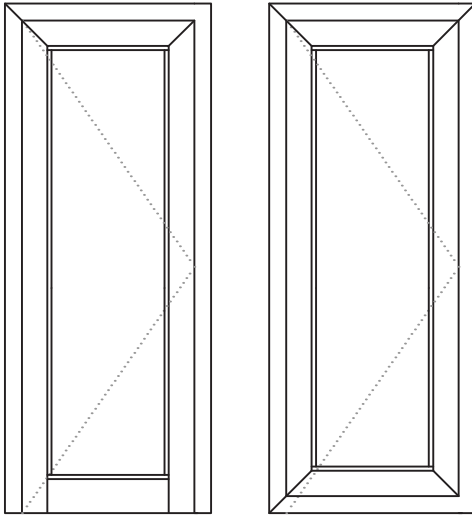

İçe Açılır Kapı

DETAY- 1
ÖLÇEK:1/1

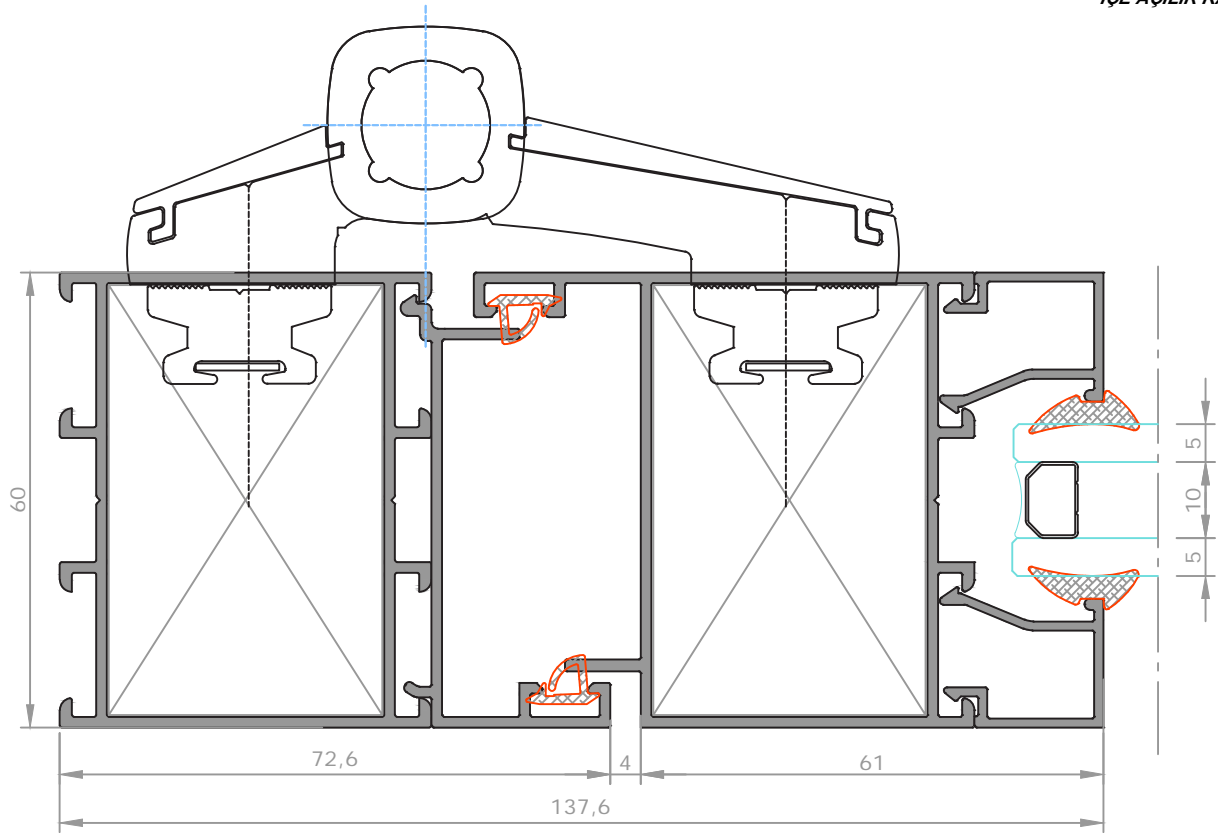
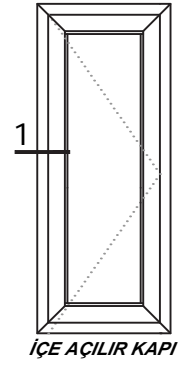

★ Yandaki profil birim ağırlıkları, bilgisayarda hesaplanmış teorik ağırlıklardır.

DETAY-2a
ÖLÇEK:1/1

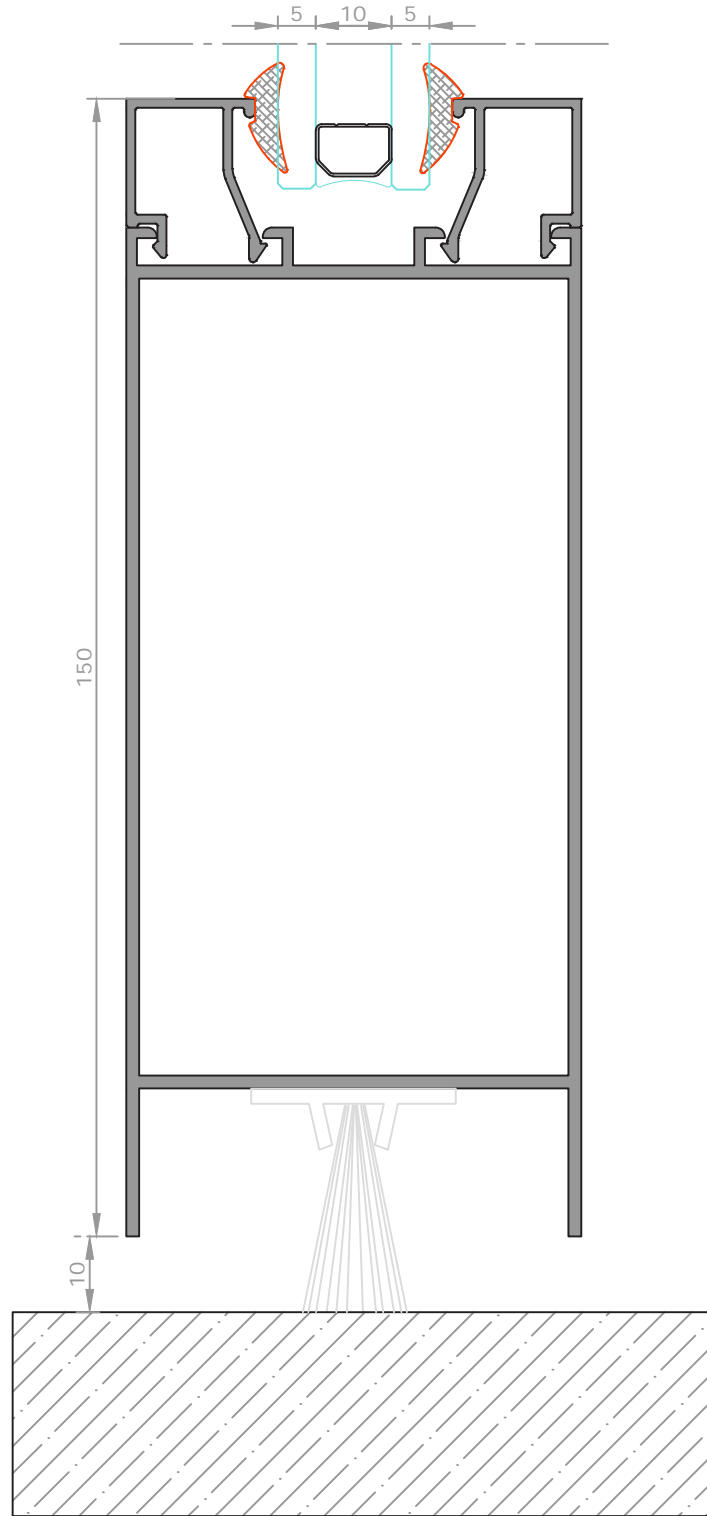
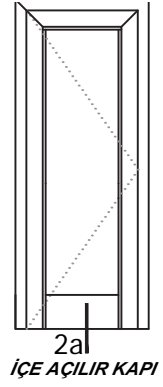

★ Yandaki profil birim ağırlıkları, bilgisayarla hesaplanmış teorik ağırlıklardır.

DETAY- 2b
ÖLÇEK:1/1

★ Yandaki profil birim ağırlıkları, bilgisayararda hesaplanmış teorik ağırlıklardır.

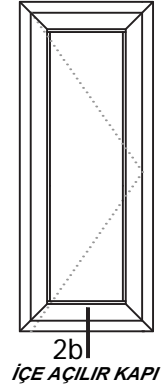
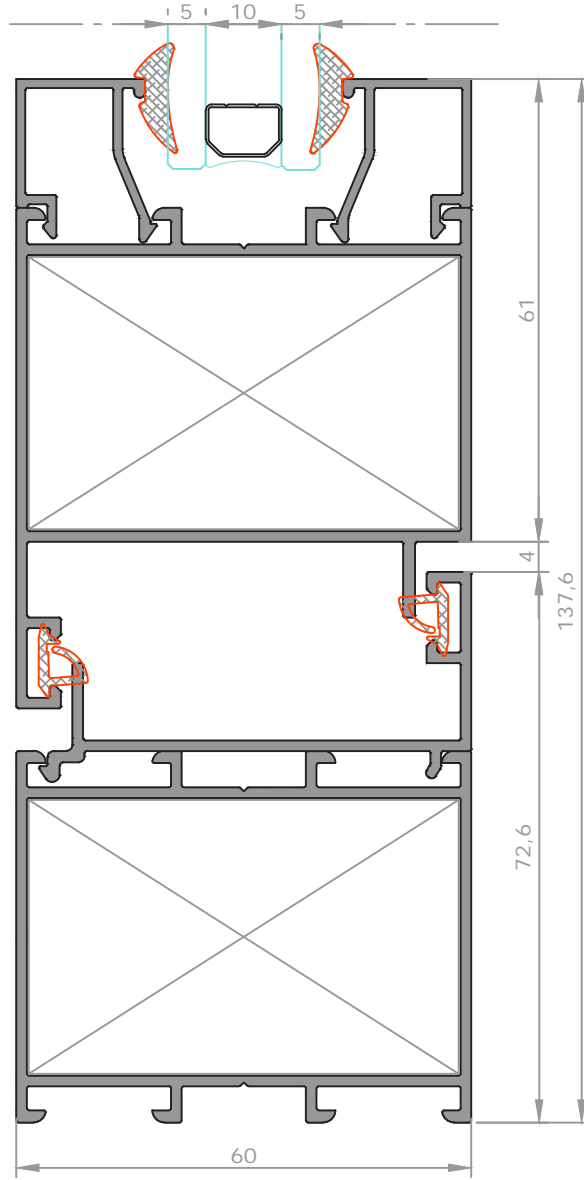

2b
İÇE AÇILIR KAPI

DETAY- 3
ÖLÇEK:1/1

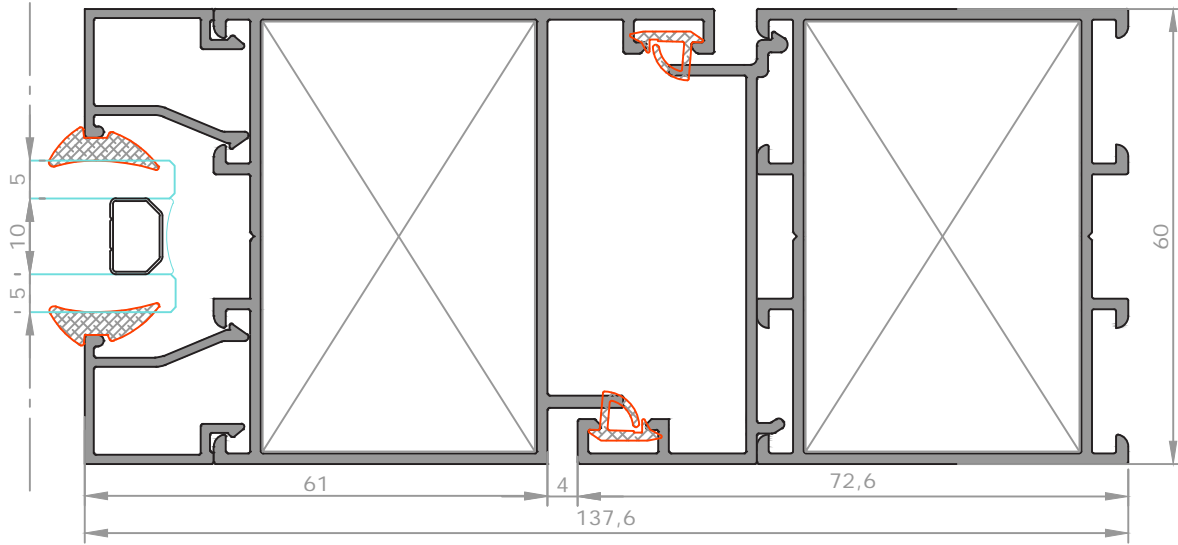
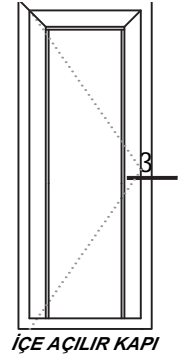

★ Yandaki profil birim ağırlıkları, bilgisayarda hesaplanmış teorik ağırlıklardır.

DETAY- 4

ÖLÇEK:1/1

★ Yandaki profil birim ağırlıkları, bilgisayarda hesaplanmış teorik ağırlıklardır.

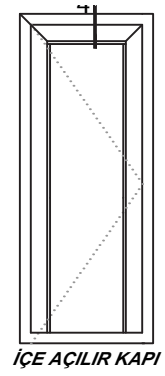
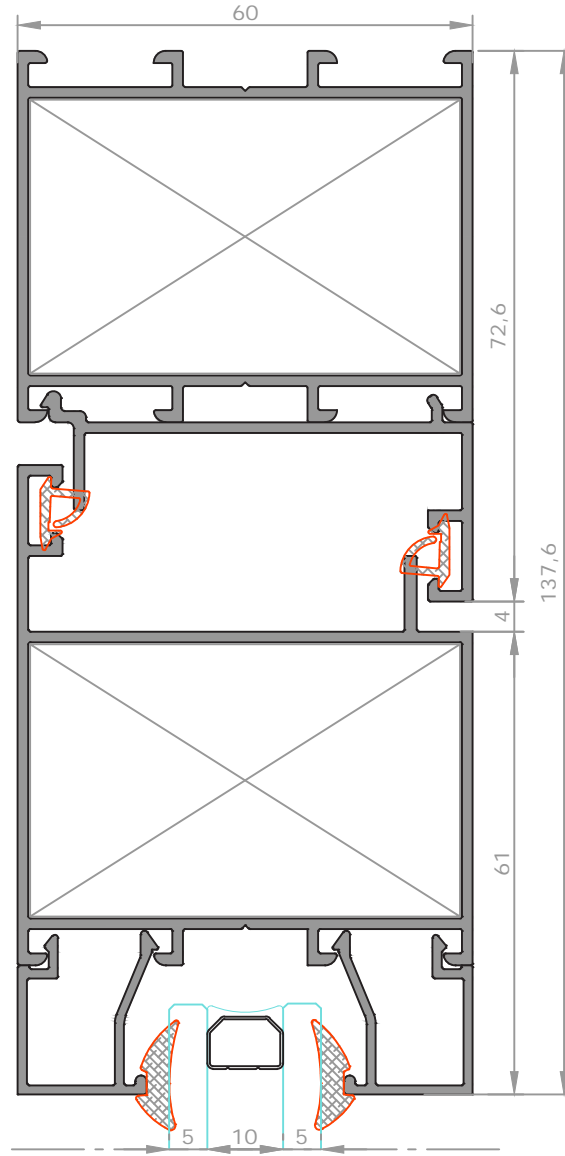

DETAY- 5
ÖLÇEK:1/1

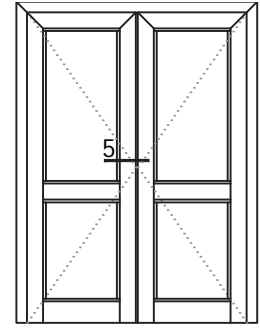

İÇE AÇILIR KAPI

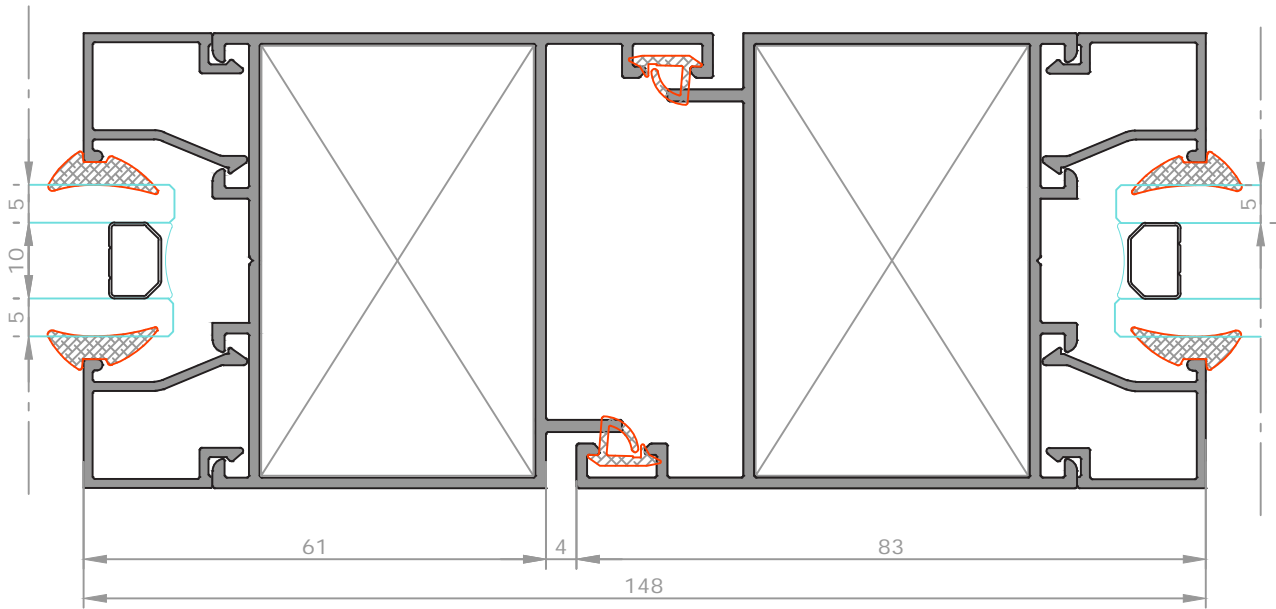

★ Yandaki profil birim ağırlıkları, bilgisayarda hesaplanmış teorik ağırlıklardır.

PROFİL KATALOĐU

DAR TUBA SERİSİ







SLIDING WINDOWS SERIE

* Profil Ağırlıkları Teorik Olup Teslim Anındaki Ağırlık Geçerlidir
* *Weight of profiles are theoretical, net weight will valid at the time of delivery.*

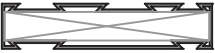
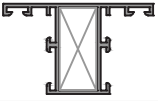
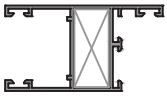
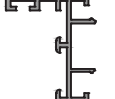
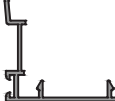
DAR TUBA SERİSİ

SLIDING WINDOWS SERIE

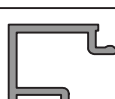
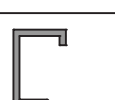
★ Yandaki profil birim ağırlıkları, bilgisayarda hesaplanmış teorik ağırlıklardır.

PROFİL KESİTİ	PROFİL KODU	PROFİL ADI	AĞIRLIK	ATALET MOMENTLERİ		SAYFA NO
				J_x (cm ⁴)	J_y (cm ⁴)	
	2100	Kasa Profili	0,687 kg/m	14,56	1,60	
	2101	Sineklikli Kasa Profili	0,919 kg/m	32,74	2,16	
	2103	Orta Kayıt Profili	0,553 kg/m	3,00	2,60	
	2102	Kanat Profili	0,636 kg/m	5,65	3,21	
	2113	Sabit Kasa Adaptör Profili	0,318 kg/m	1,50	0,35	
	2111	Kenet Adaptör Profili	0,296 kg/m	1,93	0,54	
	2112	Orta Kenet Profili	0,183 kg/m	
	2106	Alt Ray	0,160 kg/m	
	2107	Yan ve Üst Ray	0,127 kg/m	
	2110	Tek Cam Çıtası	0,191 kg/m	
	2109	Isı Cam Çıtası	0,147 kg/m	
	2115	K.Tuba Dik Bağlantı	0,335 kg/m	
	2114	KöşeTakoza	0,556 kg/m	

DAR TUBA SERİSİ

SLIDING WINDOWS SERIE

★ Yandaki profil birim ağırlıkları, bilgisayarla hesaplanmış teorik ağırlıklardır.

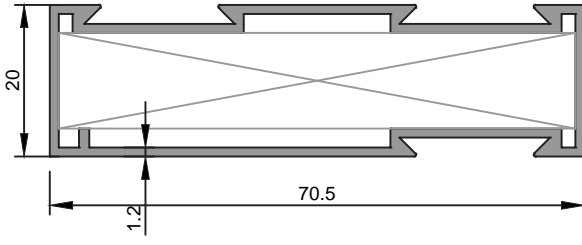

2100
Kasa Profili
0,687 kg/m
$Jx=14,56 \text{ cm}^4$ $Jy=1,60 \text{ cm}^4$

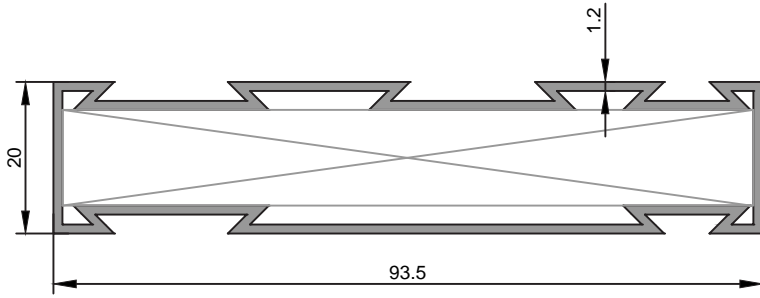

2101
Sineklikli Kasa Profili
0,919 kg/m
$Jx=32,74 \text{ cm}^4$ $Jy=2,16 \text{ cm}^4$

DAR TUBA SERİSİ

SLIDING WINDOWS SERIE

★ Yandaki profil birim ağırlıkları, bilgisayararda hesaplanmış teorik ağırlıklardır.

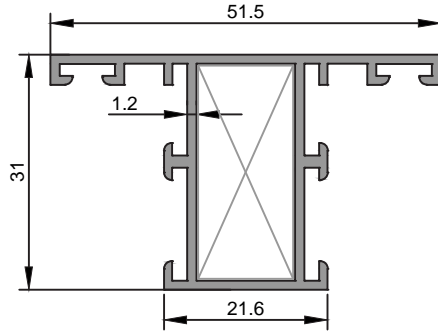

2103
Orta Kayıt Profili
0,553 kg/m
Jx=3,00 cm ⁴ Jy=2,60 cm ⁴

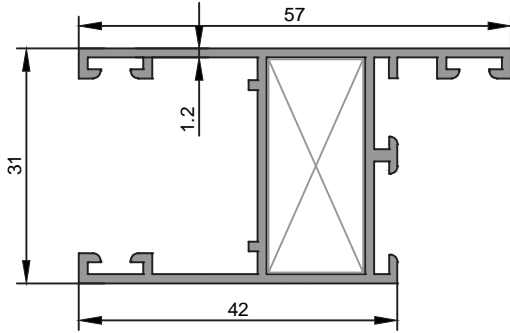

2102
Kanat Profili
0,636 kg/m
Jx=5,65 cm ⁴ Jy=3,21 cm ⁴

★ Yandaki profil birim ağırlıkları, bilgisayararda hesaplanmış teorik ağırlıklardır.

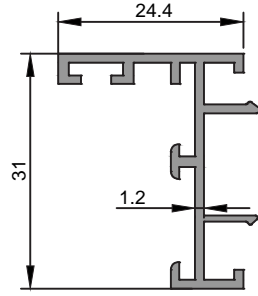

2113
Sabit Kasa Adaptör Profili
0,318 kg/m
$J_x=1,50 \text{ cm}^4$ $J_y=0,35 \text{ cm}^4$

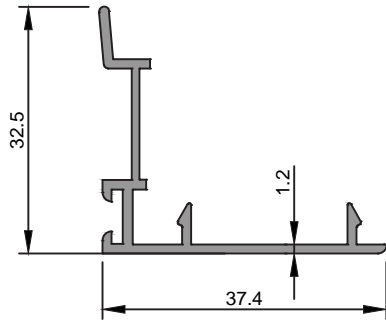

2111
Kenet Adaptör Profili
0,296 kg/m
$J_x=1,93 \text{ cm}^4$ $J_y=0,54 \text{ cm}^4$

★ Yandaki profil birim ağırlıkları, bilgisayarla hesaplanmış teorik ağırlıklardır.

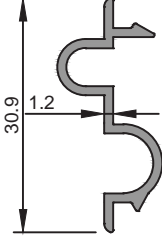

2112
Orta Kenet Profili
0,183 kg/m

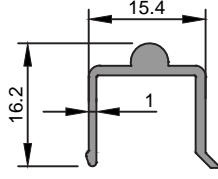

2106
Alt Ray
0,160 kg/m

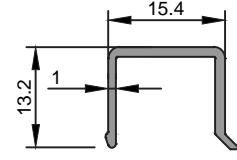

2107
Yan ve Üst Ray
0,127 kg/m

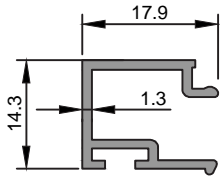

2110
Tek Cam Çıtası
0,191 kg/m

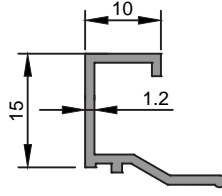

2109
İsı Cam Çıtası
0,147 kg/m

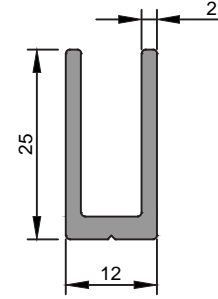

2115
K.Tuba Dık Bağlantı
0,335 kg/m

DAR TUBA SERİSİ

SLIDING WINDOWS SERIE

★ Yandaki profil birim ağırlıkları, bilgisayararda hesaplanmış teorik ağırlıklardır.

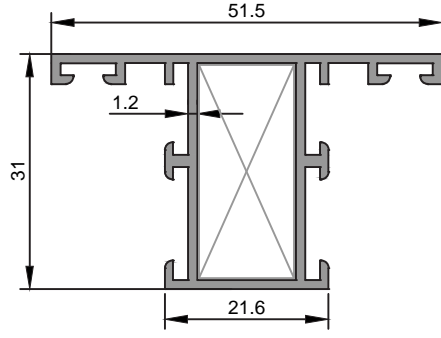

2103
Orta Kayıt Profili
0,553 kg/m
$J_x=3,00 \text{ cm}^4$ $J_y=2,60 \text{ cm}^4$

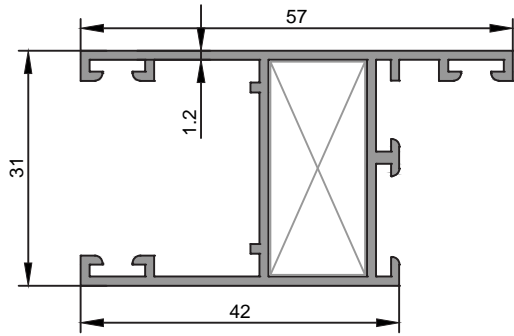

2102
Kanat Profili
0,636 kg/m
$J_x=5,65 \text{ cm}^4$ $J_y=3,21 \text{ cm}^4$

DAR TUBA SERİSİ

SLIDING WINDOWS SERIE

★ Yandaki profil birim ağırlıkları, bilgisayarla hesaplanmış teorik ağırlıklardır.

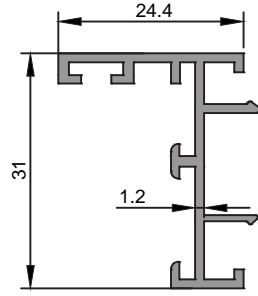

2113
Sabit Kasa Adaptör Profili
0,318 kg/m
$J_x=1,50 \text{ cm}^4$ $J_y=0,35 \text{ cm}^4$

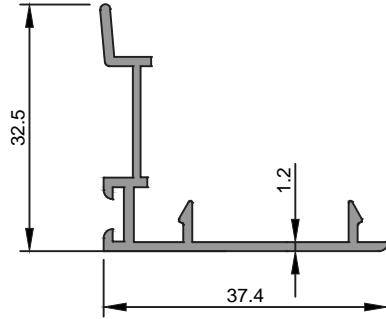

2111
Kenet Adaptör Profili
0,296 kg/m
$J_x=1,93 \text{ cm}^4$ $J_y=0,54 \text{ cm}^4$

★ Yandaki profil birim ağırlıkları, bilgisayarda hesaplanmış teorik ağırlıklardır.

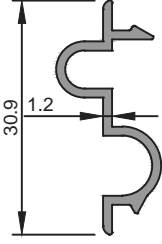

2112
Orta Kenet Profili
0,183 kg/m

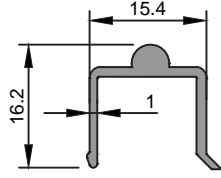

2106
Alt Ray
0,160 kg/m

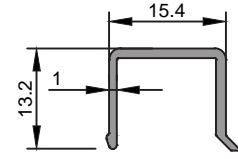

2107
Yan ve Üst Ray
0,127 kg/m

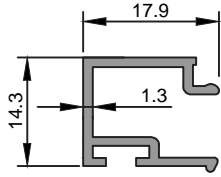

2110
Tek Cam Çıtası
0,191 kg/m

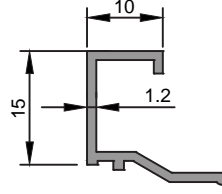

2109
İki Cam Çıtası
0,147 kg/m

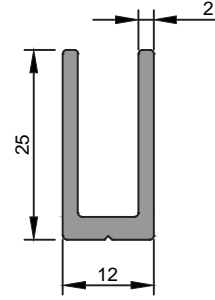

2115
K.Tuba Dik Bağlantı
0,335 kg/m

KÖŞE TAKOZU KESİM ÖLÇÜLERİ

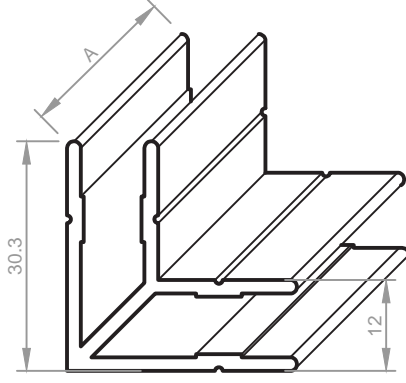

2114
Köşe Takozu
0,556 kg/m

Aksesuar Kodu	Profil Kodu	Kesim Ölçüsü A(mm)
K2114 676	2100	67.6
K2114 906	2101	90.6
K2114 281	2102	28.1
K2114 281	2113	28.1

★ Yandaki profil birim ağırlıkları, bilgisayarda hesaplanmış teorik ağırlıklardır.

DAR TUBA SERİSİ

SLIDING WINDOWS SERIE

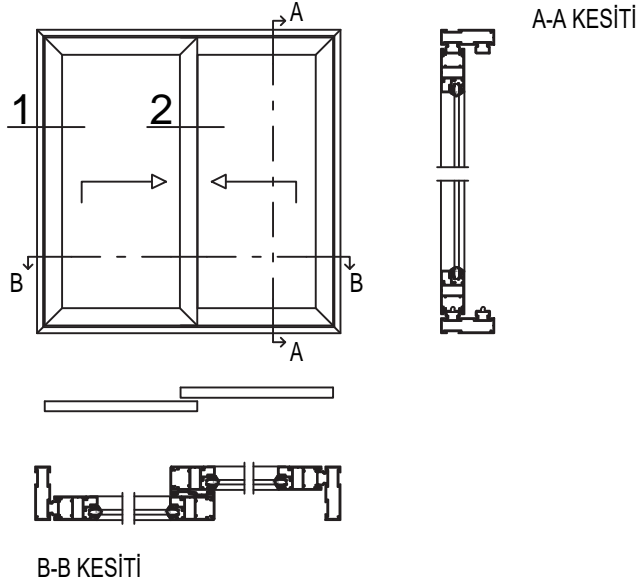

★ Yandaki profil birim ağırlıkları, bilgisayararda hesaplanmış teorik ağırlıklardır.

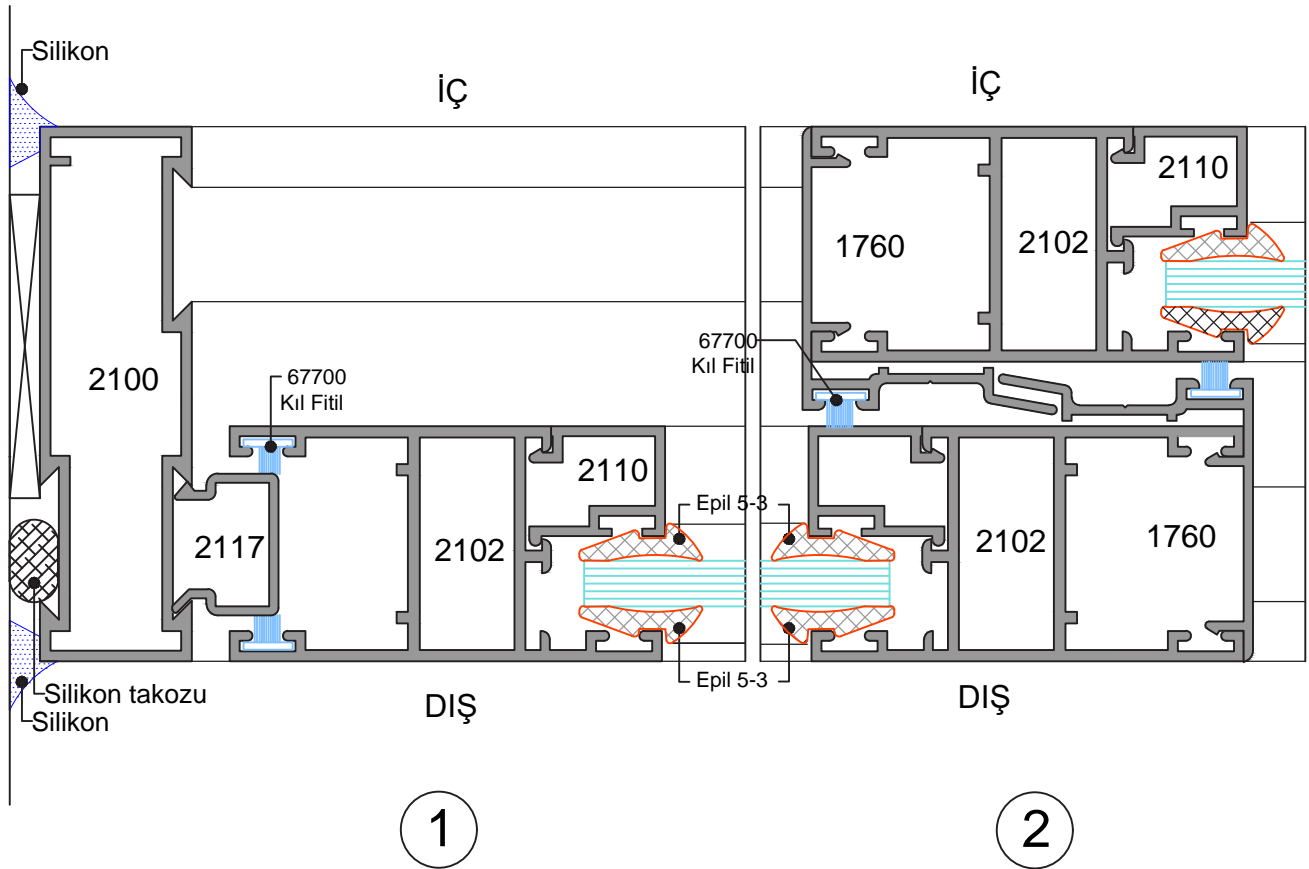

DAR TUBA SERİSİ

SLIDING WINDOWS SERIE

★ Yandaki profil birim ağırlıkları, bilgisayararda hesaplanmış teorik ağırlıklardır.

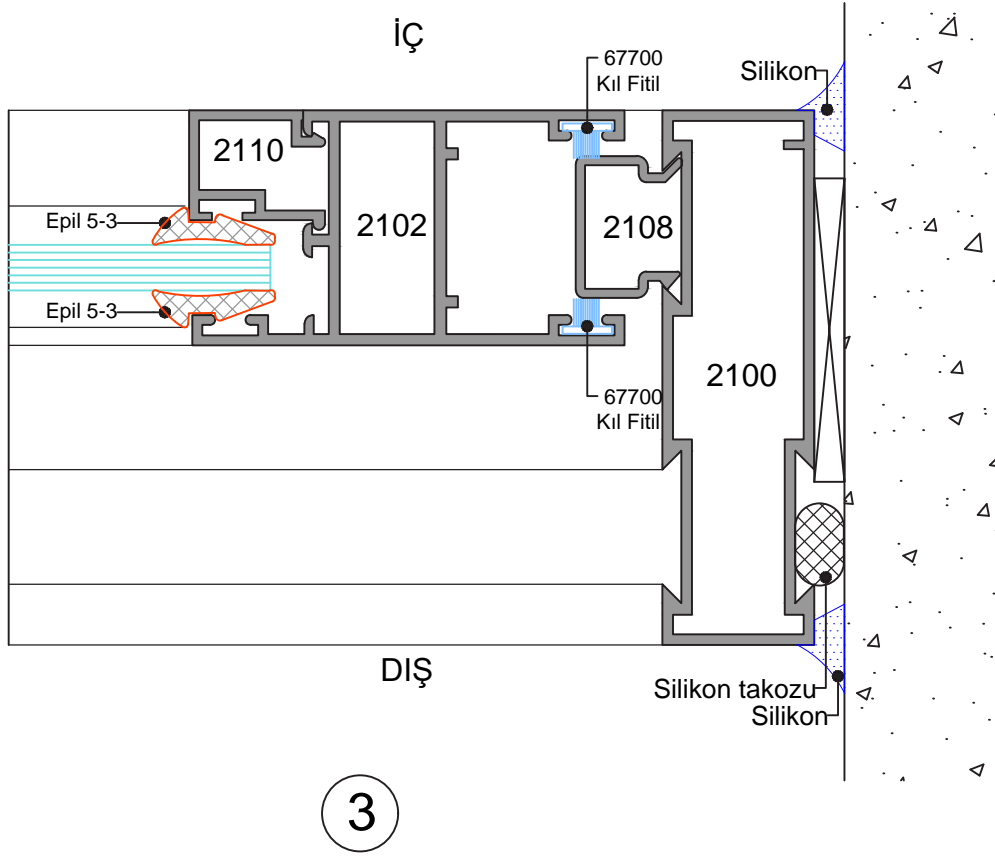
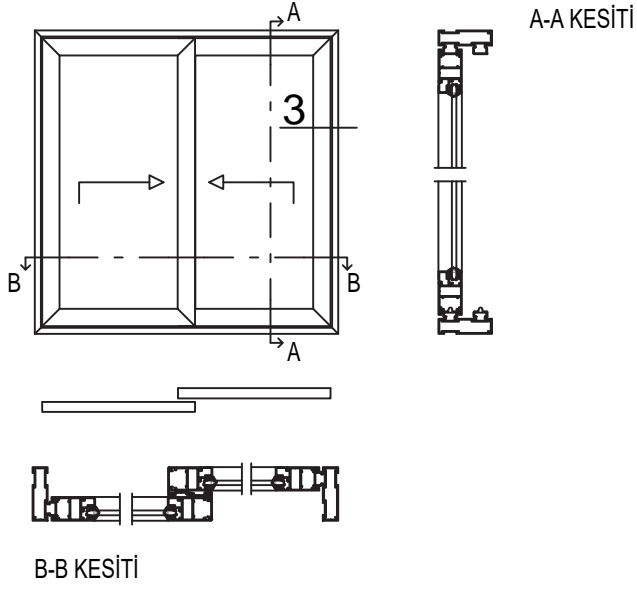

PROFİL KATALOĐU

GENİŐ TUBA SERİSİ







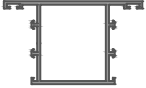
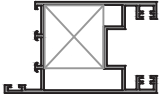

SLIDING WINDOWS SERIE

* Profil Ađırlıkları Teorik Olup Teslim Anındaki Ađırlık Geęerlidir
* *Weight of profiles are theoretical, net weight will valid at the time of delivery.*

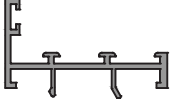
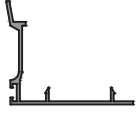
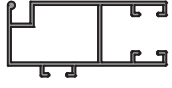

GENİŞ TUBA SERİSİ

SLIDING WINDOWS SERIE

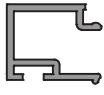
★ Yandaki profil birim ağırlıkları, bilgisayarda hesaplanmış teorik ağırlıklardır.

PROFİL KESİTİ	PROFİL KODU	PROFİL ADI	AĞIRLIK	ATALET MOMENTLERİ		SAYFA NO
				J_x (cm ⁴)	J_y (cm ⁴)	
	2116	Kasa Profili	1,243 kg/m	52,66	7,05	
	1770	Orta Kayıt Profili	1,110 kg/m	15,68	12,49	
	2119	Kanat Profili	1,209 kg/m	21,48	13,33	
	2104	Sineklik Kanat Profili	0,713 kg/m	7,05	1,27	
	2127	Adaptör Profili	0,450 kg/m	4,28	0,45	
	2125	Kenet Adaptör Profili	0,433 kg/m	5,42	1,35	
	1843	Sürme Sineklik Profili	0,360 kg/m	2,34	0,65	
	2126	Orta Kenet Profili	0,298 kg/m	1,50	0,15	
	2117	Alt Ray	0,281 kg/m	0,56	0,29	
	2118	Üst Ray	0,219 kg/m	0,61	0,15	
	2132	Çiftli Ray	1,056 kg/m	30,09	1,20	
	2788	Sineklik Rayı	0,325 kg/m	2,48	0,11	
	2108	Sineklik Çıtası	0,137 kg/m	
	2110	Tek Cam Çıtası	0,191 kg/m	

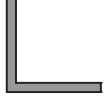
★ Yandaki profil birim ağırlıkları, bilgisayarda hesaplanmış teorik ağırlıklardır.

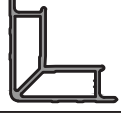
PROFİL KESİTİ	PROFİL KODU	PROFİL ADI	AĞIRLIK	ATALET MOMENTLERİ		SAYFA NO
				J _x (cm ⁴)	J _y (cm ⁴)	
	2128	Tek Cam Çıtası	0,260 kg/m	
	1114	Tuba Bağlantı	0,824 kg/m	
	2431	Köşe Takozu	4,775 kg/m	
	2432	Köşe Takozu	1,648 kg/m	

GENİŞ TUBA SERİSİ

SLIDING WINDOWS SERIE

★ Yandaki profil birim ağırlıkları, bilgisayarla hesaplanmış teorik ağırlıklardır.

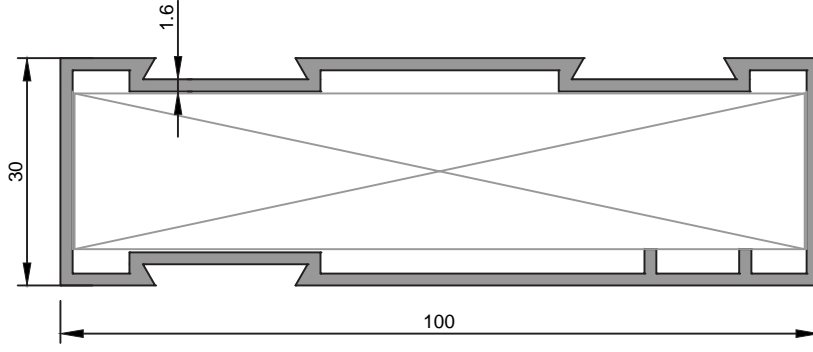

2116
Kasa Profili
1,243 kg/m
Jx=52,66 cm ⁴ Jy=7,05 cm ⁴

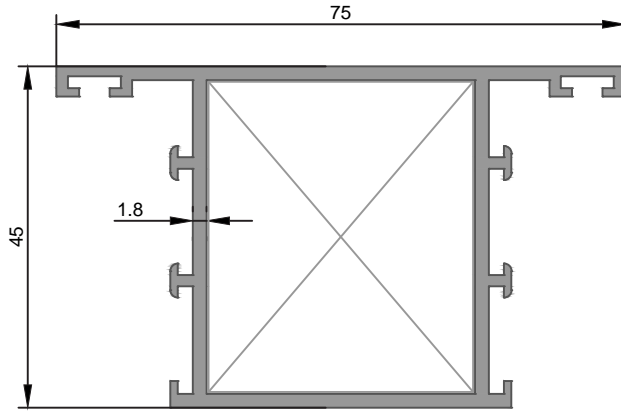

1770
Orta Kayıt Profili
1,110 kg/m
Jx=15,68 cm ⁴ Jy=12,49 cm ⁴

GENİŞ TUBA SERİSİ

SLIDING WINDOWS SERIE

★ Yandaki profil birim ağırlıkları, bilgisayararda hesaplanmış teorik ağırlıklardır.

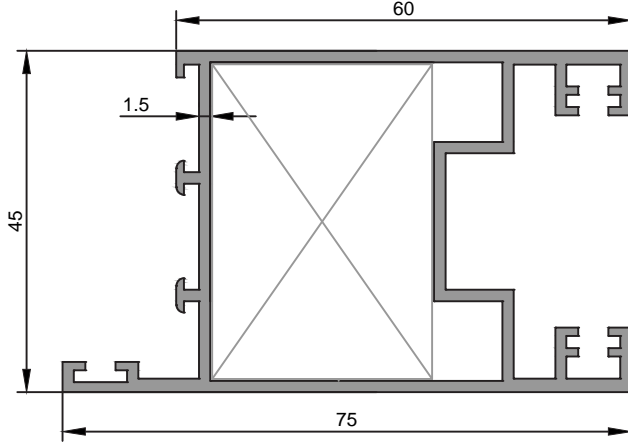

2119
Kanat Profili
1,209 kg/m
Jx=21,48 cm ⁴ Jy=13,33 cm ⁴

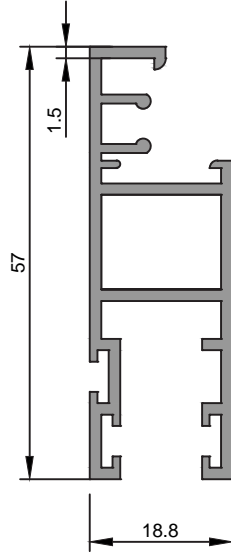

2104
Sineklik Kanat Profili
0,713 kg/m
Jx=7,05 cm ⁴ Jy=1,27 cm ⁴

GENİŞ TUBA SERİSİ

SLIDING WINDOWS SERIE

★ Yandaki profil birim ağırlıkları, bilgisayarla hesaplanmış teorik ağırlıklardır.

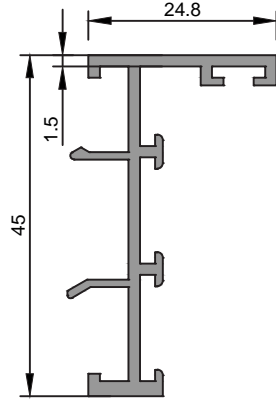

2127
Adaptör Profili
0,450 kg/m
Jx=4,28 cm ⁴ Jy=0,45 cm ⁴

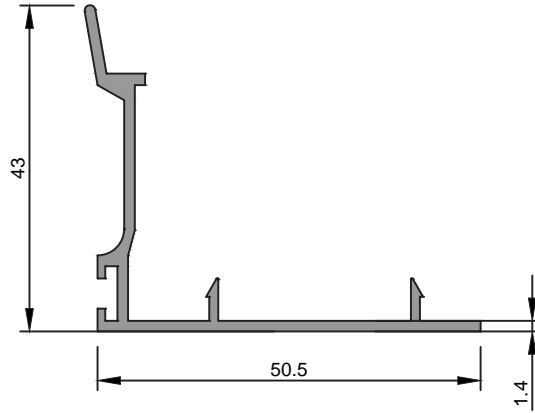

2125
Kenet Adaptörü
0,433 kg/m
Jx=5,42 cm ⁴ Jy=1,35 cm ⁴

GENİŞ TUBA SERİSİ

SLIDING WINDOWS SERIE

★ Yandaki profil birim ağırlıkları, bilgisayarda hesaplanmış teorik ağırlıklardır.

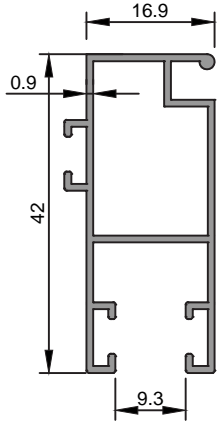

1843
Sürme Sineklik Profili
0,360 kg/m
Jx=2,34 cm ⁴ Jy=0,65 cm ⁴

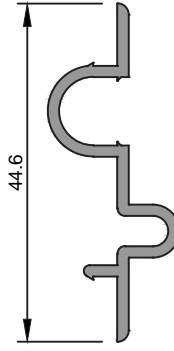

2126
Orta Kenet Profili
0,298 kg/m
Jx=1,50 cm ⁴ Jy=0,15 cm ⁴

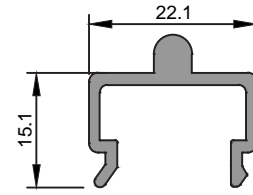

2117
Alt Ray
0,281 kg/m
Jx=0,56 cm ⁴ Jy=0,29 cm ⁴

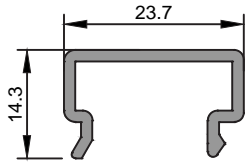

2118
Üst Ray
0,219 kg/m
Jx=0,61 cm ⁴ Jy=0,15 cm ⁴

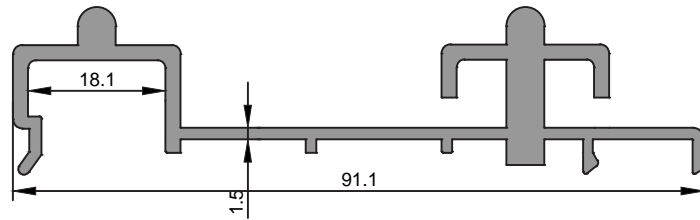

2132
Çiftli Ray
1,056 kg/m
Jx=30,09 cm ⁴ Jy=1,20 cm ⁴

★ Yandaki profil birim ağırlıkları, bilgisayarda hesaplanmış teorik ağırlıklardır.

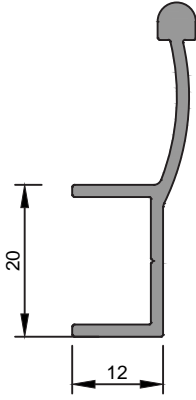

2788
Sineklik Rayı
0,325 kg/m
$Jx=2,48 \text{ cm}^4$ $Jy=0,11 \text{ cm}^4$

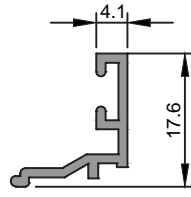

2108
Sineklik Çıtası
0,137 kg/m

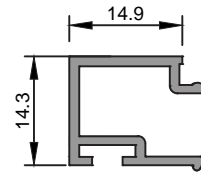

2110
Tek Cam Çıtası
0,191 kg/m

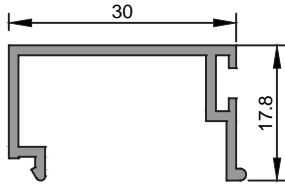

2128
Tek Cam Çıtası
0,260 kg/m

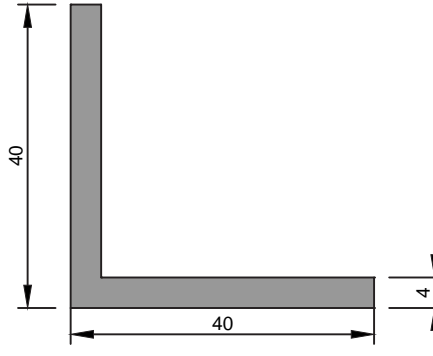

1114
Tuba Bağlantı
0,824 kg/m

KÖŞE TAKOZU KESİM ÖLÇÜLERİ

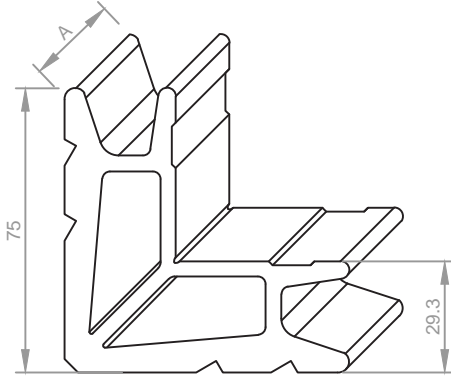

2431

Köşe Takoğu

4,775 kg/m

Aksesuar Kodu	Profil Kodu	Kesim Ölçüsü A(mm)
K2431 415	2119	41.5

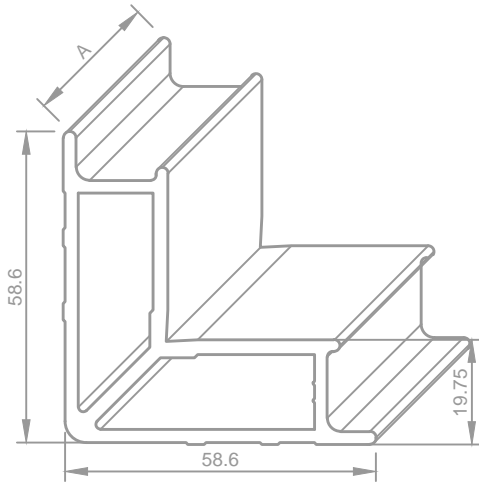

2432

Köşe Takoğu

1,648 kg/m

Aksesuar Kodu	Profil Kodu	Kesim Ölçüsü A(mm)
K2432 963	2116	96.3

★ Yandaki profil birim ağırlıkları, bilgisayarlı hesaplanmış teorik ağırlıklardır.

GENİŞ TUBA SERİSİ

SLIDING WINDOWS SERIE

★ Yandaki profil birim ağırlıkları, bilgisayarla hesaplanmış teorik ağırlıklardır.

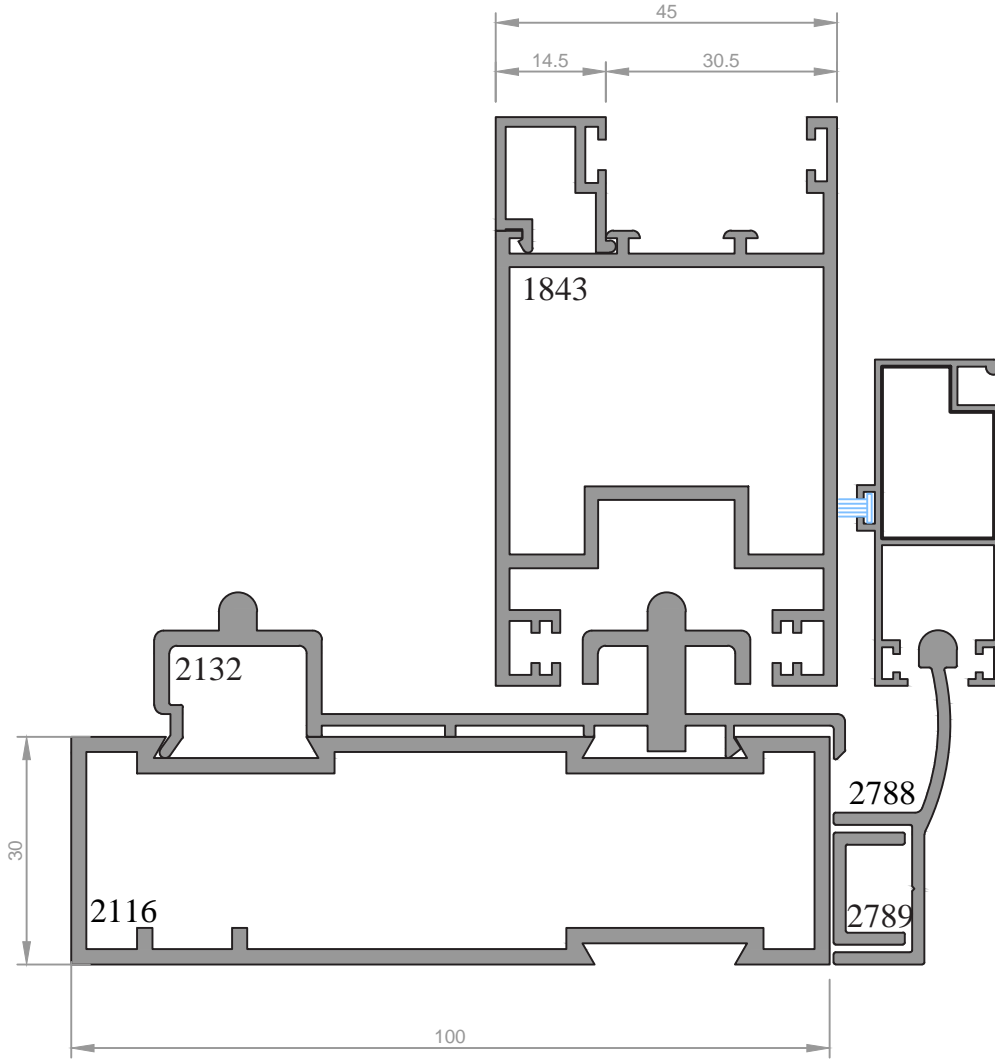

PROFİL KATALOĞU

VERANDA PROFİLLERİ

VERANDA PROFILES







* Profil Ağırlıkları Teorik Olup Teslim Anındaki Ağırlık Geçerlidir

* *Weight of profiles are theoretical, net weight will valid at the time of delivery.*

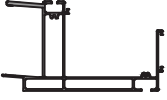
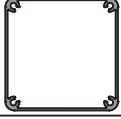
H1 VERANDA PROFİLLERİ

H1 VERANDA PROFILES

★ Yandaki profil birim ağırlıkları, bilgisayarda hesaplanmış teorik ağırlıklardır.

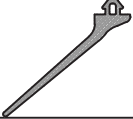
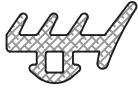
PROFİL KESİTİ	PROFİL KODU	PROFİL ADI	AĞIRLIK	ATALET MOMENTLERİ		SAYFA NO
				J_x (cm ⁴)	J_y (cm ⁴)	
	4089	Oluk Profili	3,812 kg/m	407,26	137,52	
	4084	Dikme Profili	4,060 kg/m	383,39	383,39	
	4086	Duvar Profili	2,623 kg/m	24,30	19,91	
	4085	Taşıyıcı Profil	2,699 kg/m	122,17	31,78	
	4087	Veranda Profili	0,462 kg/m	15,21	0,11	
	4088	Taşıyıcı Kapak Profili	0,640 kg/m	12,39	3,19	
	4090	Oluk Kapak Profili	1,523 kg/m	136,56	1,04	
	HL60	Fital	283 gr/m	
	HL61	Dış Cam Fitali	93 gr/m	

H1 VERANDA PROFİLLERİ

H1 VERANDA PROFILES

★ Yandaki profil birim ağırlıkları, bilgisayar yardımıyla hesaplanmış teorik ağırlıklardır.

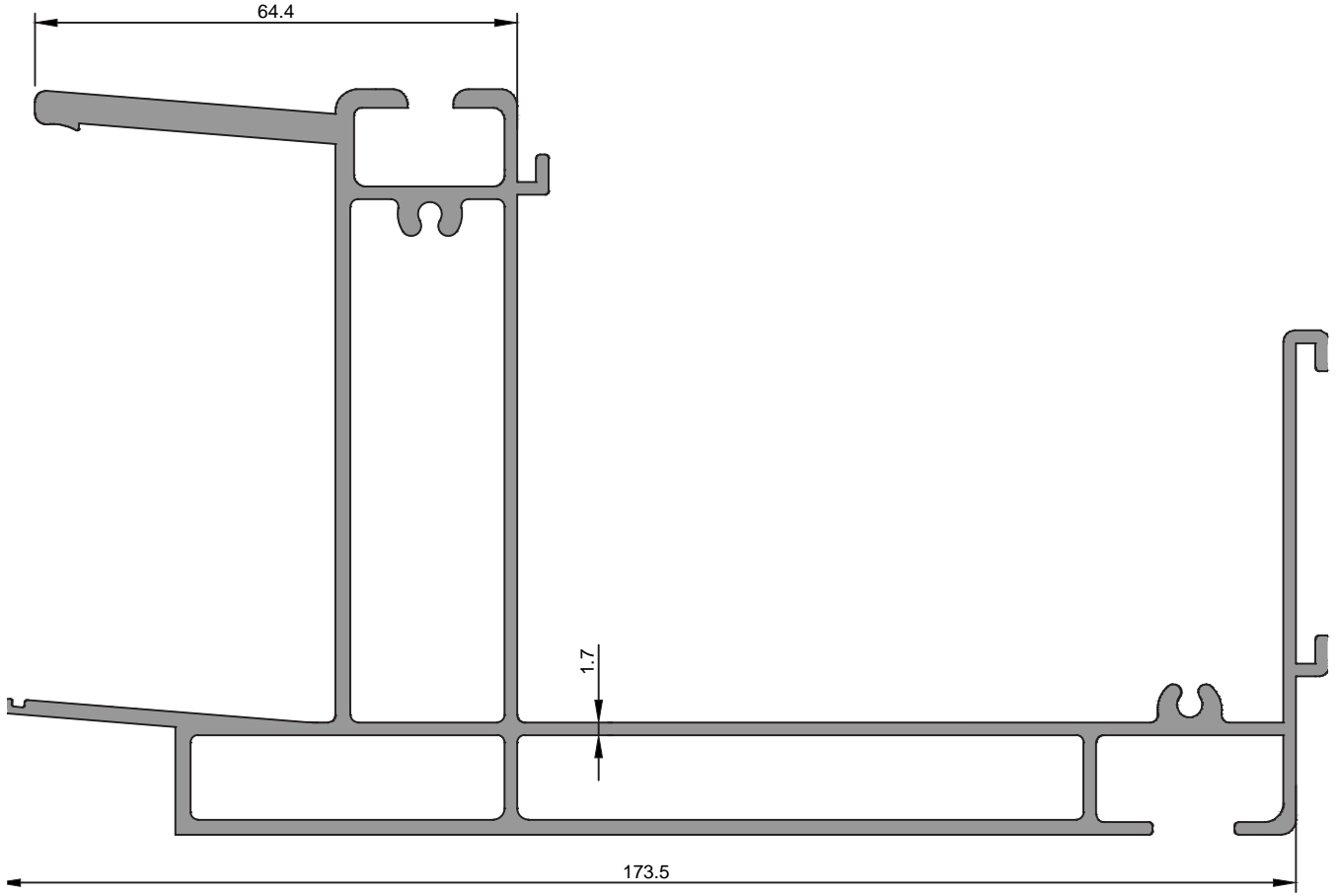

4089
Oluk Profili
3,812 kg/m
$J_x=407,26 \text{ cm}^4$ $J_y=137,52 \text{ cm}^4$

H1 VERANDA PROFİLLERİ

H1 VERANDA PROFILES

★ Yandaki profil birim ağırlıkları, bilgisayarla hesaplanmış teorik ağırlıklardır.

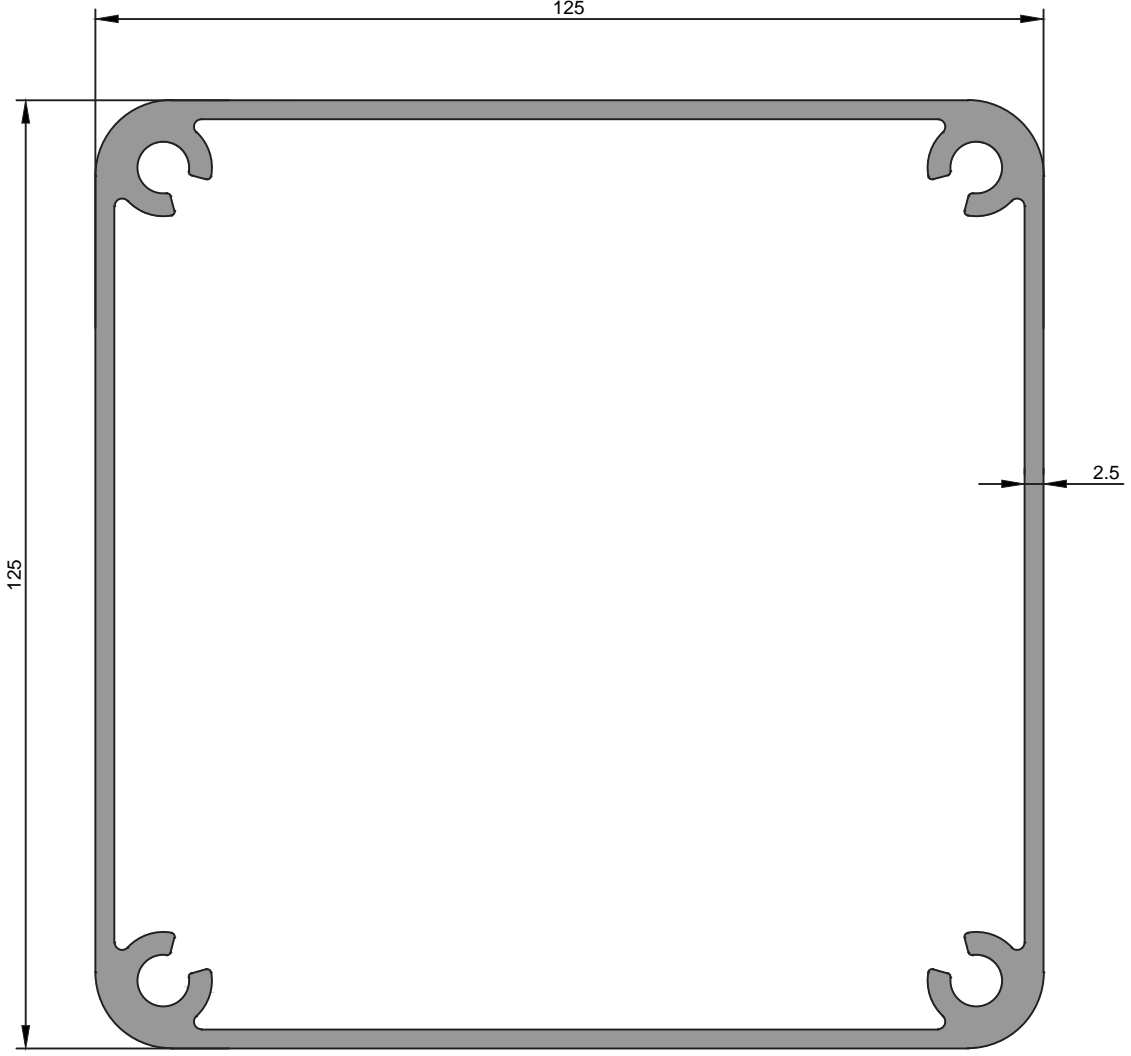

4084
Dikme Profili
4,060 kg/m
$J_x=383,39 \text{ cm}^4$ $J_y=383,39 \text{ cm}^4$

H1 VERANDA PROFİLLERİ

H1 VERANDA PROFILES

★ Yandaki profil birim ağırlıkları, bilgisayararda hesaplanmış teorik ağırlıklardır.

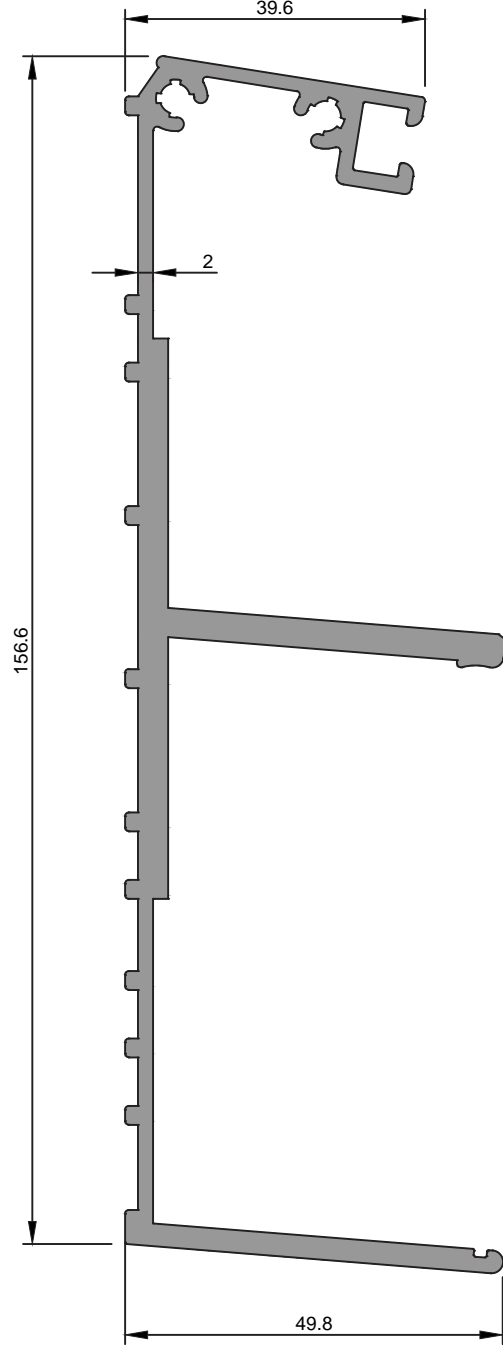

4086
Duvar Profili
2,623 kg/m
$J_x=24,30 \text{ cm}^4$ $J_y=19,91 \text{ cm}^4$

H1 VERANDA PROFİLLERİ

H1 VERANDA PROFILES

★ Yandaki profil birim ağırlıkları, bilgisayarla hesaplanmış teorik ağırlıklardır.

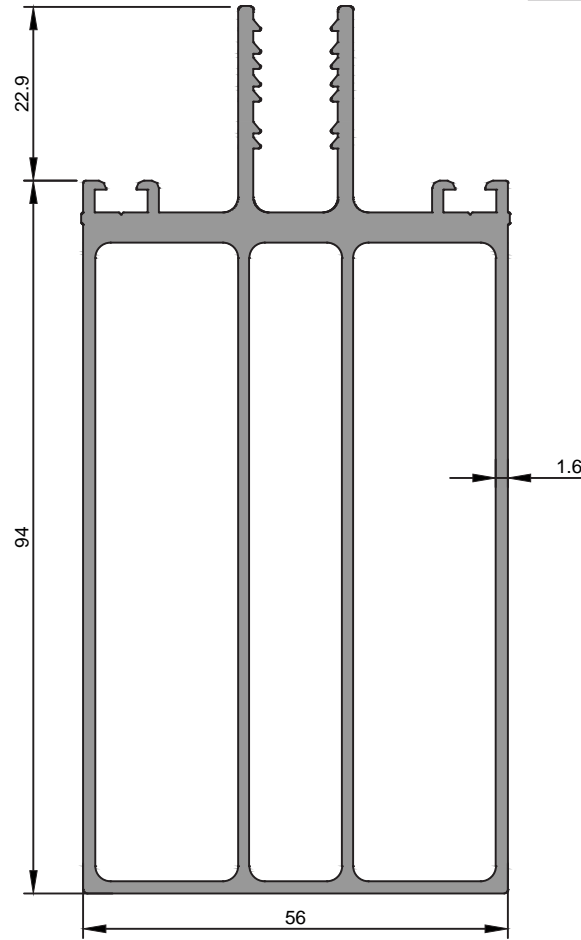

H1 VERANDA PROFİLLERİ

H1 VERANDA PROFILES

★ Yandaki profil birim ağırlıkları, bilgisayar yardımıyla hesaplanmış teorik ağırlıklardır.

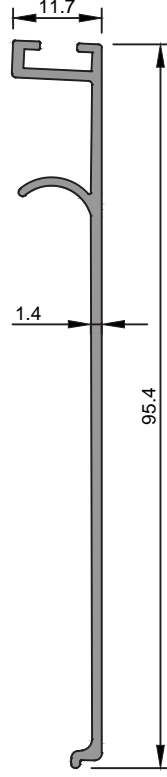

4087
Veranda Profili
0,462 kg/m
$J_x=15,21 \text{ cm}^4$ $J_y=0,11 \text{ cm}^4$

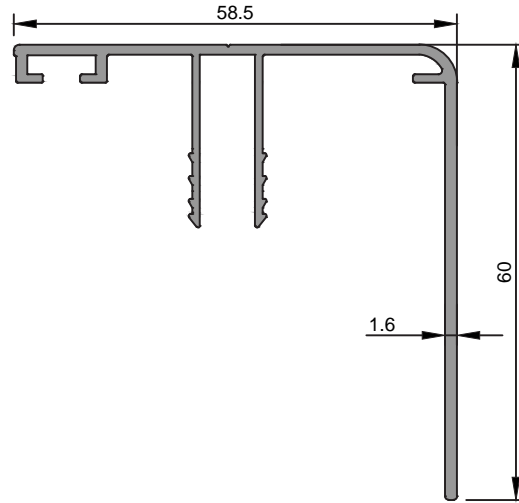

4088
Taşıyıcı Kapak Profili
0,640 kg/m
$J_x=12,39 \text{ cm}^4$ $J_y=3,19 \text{ cm}^4$

H1 VERANDA PROFİLLERİ

H1 VERANDA PROFILES

★ Yandaki profil birim ağırlıkları, bilgisayararda hesaplanmış teorik ağırlıklardır.

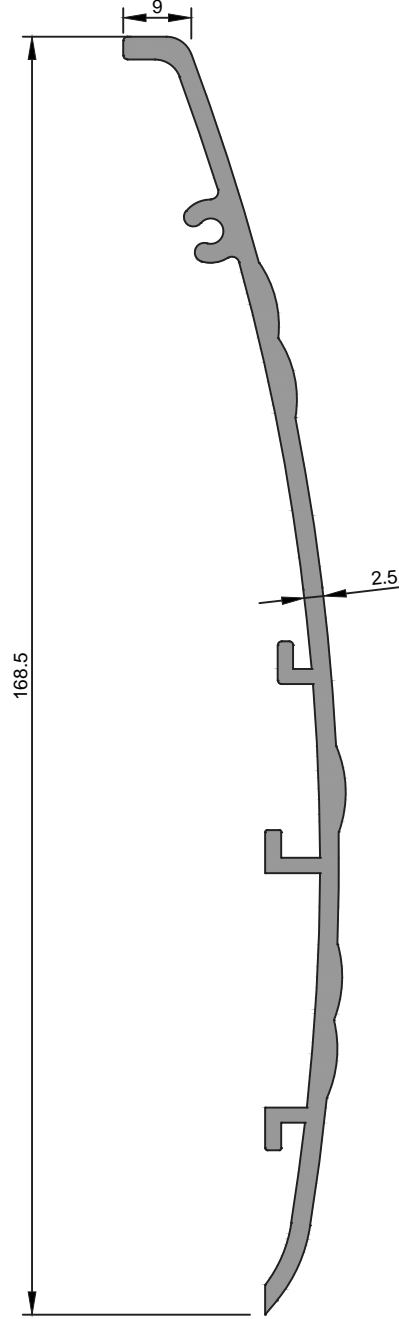

4090
Oluk Kapak Profili
1,523 kg/m
$J_x=136,56 \text{ cm}^4$ $J_y=1,04 \text{ cm}^4$

H1 VERANDA PROFİLLERİ

H1 VERANDA PROFILES



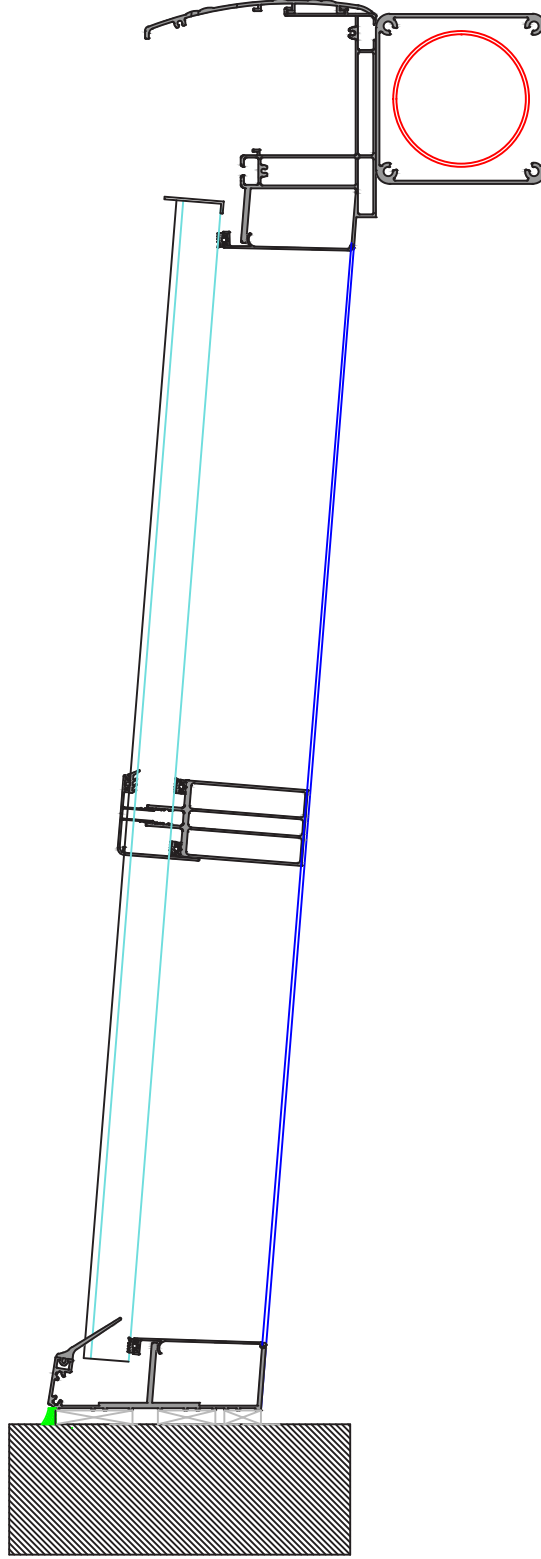





★ Yandaki profil birim ağırlıkları, bilgisayarda hesaplanmış teorik ağırlıklardır.

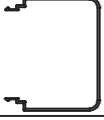

H2 VERANDA PROFİLLERİ

H2 VERANDA PROFILES

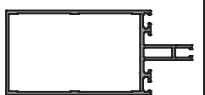
★ Yandaki profil birim ağırlıkları, bilgisayarda hesaplanmış teorik ağırlıklardır.

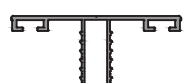
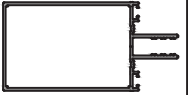
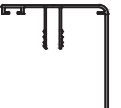
PROFİL KESİTİ	PROFİL KODU	PROFİL ADI	AĞIRLIK	ATALET MOMENTLERİ		SAYFA NO
				J_x (cm ⁴)	J_y (cm ⁴)	
	4393	Oluk Profili	4,176 kg/m	523,36	167,84	
	4436	Dikme Profili	2,013 kg/m	125,32	25,42	
	4435	Dikme Kapak Profili	1,606 kg/m	122,77	55,84	
	4439	Duvar Profili	2,386 kg/m	378,37	41,58	
	4437	Oluk Kapak Profili	1,250kg/m	60,92	5,79	
	4438	Veranda Profili	0767 kg/m	28,68	1,70	
	2972	86'lıkYatay Taşıyıcı Profili	1,643 kg/m	73,83	21,32	
	2019	Kapak Altı Profili	0,430 kg/m	
	2020	Kapak Profili	0,333 kg/m	
	3325	Taşıyıcı Kapak Profili	0,428 kg/m	
	4504	Taşıyıcı Profil	1,672 kg/m	79,60	27,16	
	4088	Taşıyıcı Kapak Profili	0,640 kg/m	

H2 VERANDA PROFİLLERİ

H2 VERANDA PROFILES

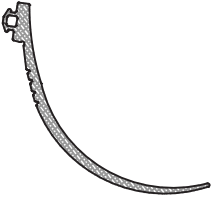
AKSESUAR KESİTİ	AKSESUAR KODU	AKSESUAR ADI	AĞIRLIK	PAKETLEME	SAYFA NO
	HL76	Cam Fitili	61 gr/m	15 kg/ 245 m	
	HL99	Veranda Fitili	340 gr/m	15 kg /44 m	

★ Yandaki profil birim ağırlıkları, bilgisayarda hesaplanmış teorik ağırlıklardır.

H2 VERANDA PROFİLLERİ

H2 VERANDA PROFILES

★ Yandaki profil birim ağırlıkları, bilgisayarda hesaplanmış teorik ağırlıklardır.

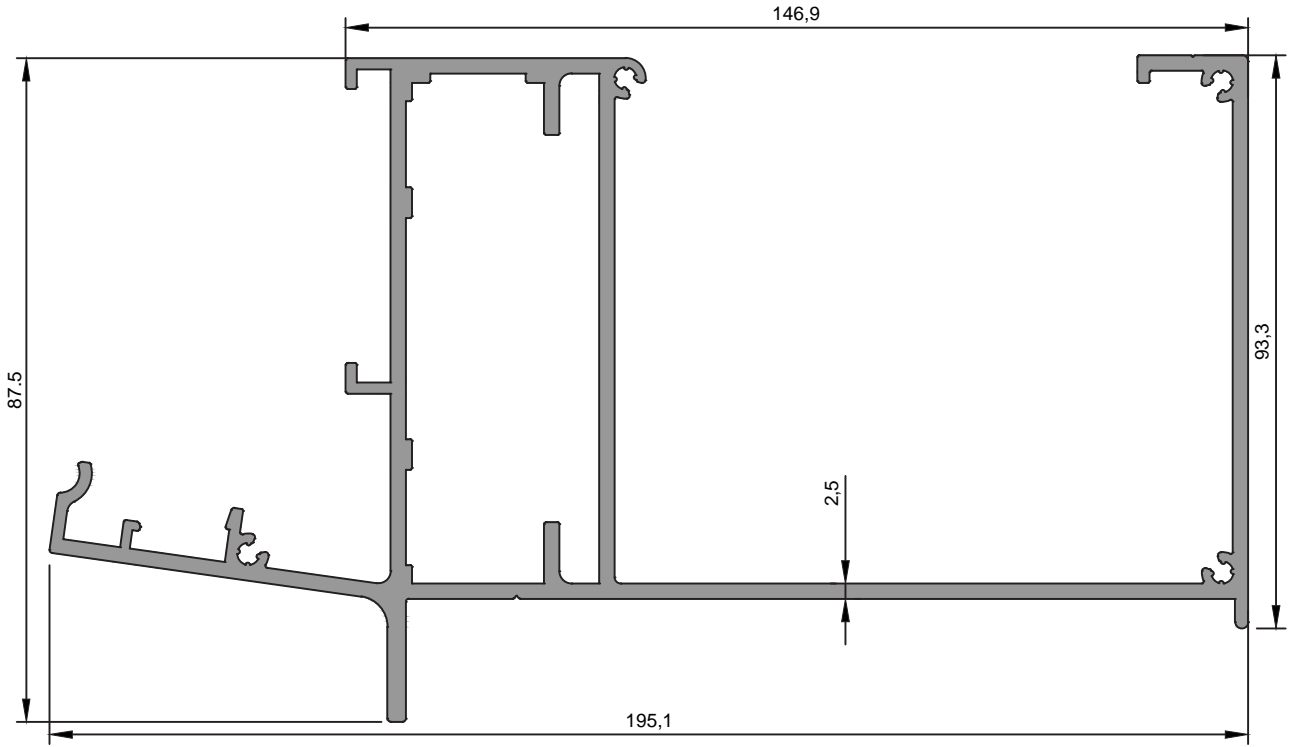

H2 VERANDA PROFİLLERİ

H2 VERANDA PROFILES

★ Yandaki profil birim ağırlıkları, bilgisayararda hesaplanmış teorik ağırlıklardır.

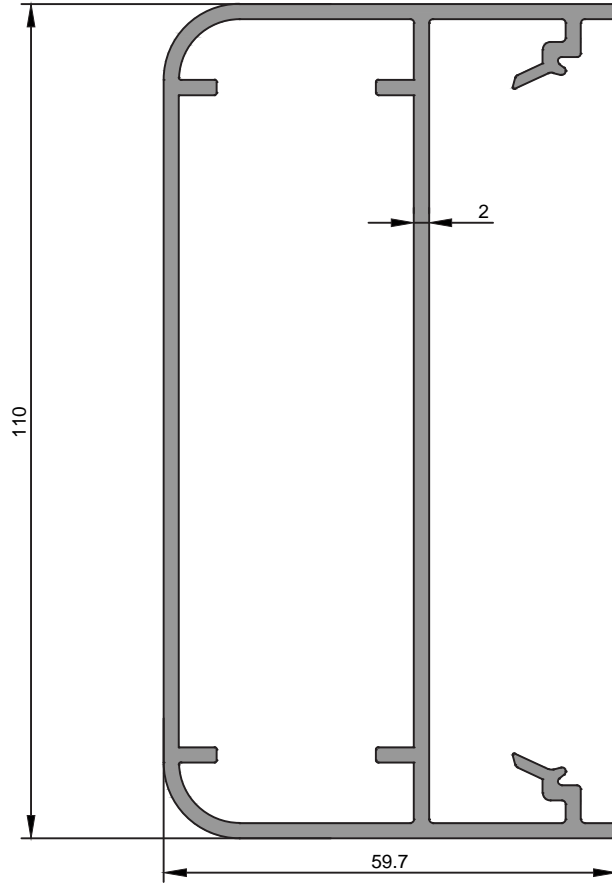

4436
Dikme Profili
2,013 kg/m
$J_x=125,32 \text{ cm}^4$ $J_y=25,42 \text{ cm}^4$

H2 VERANDA PROFİLLERİ

H2 VERANDA PROFILES

★ Yandaki profil birim ağırlıkları, bilgisayarla hesaplanmış teorik ağırlıklardır.

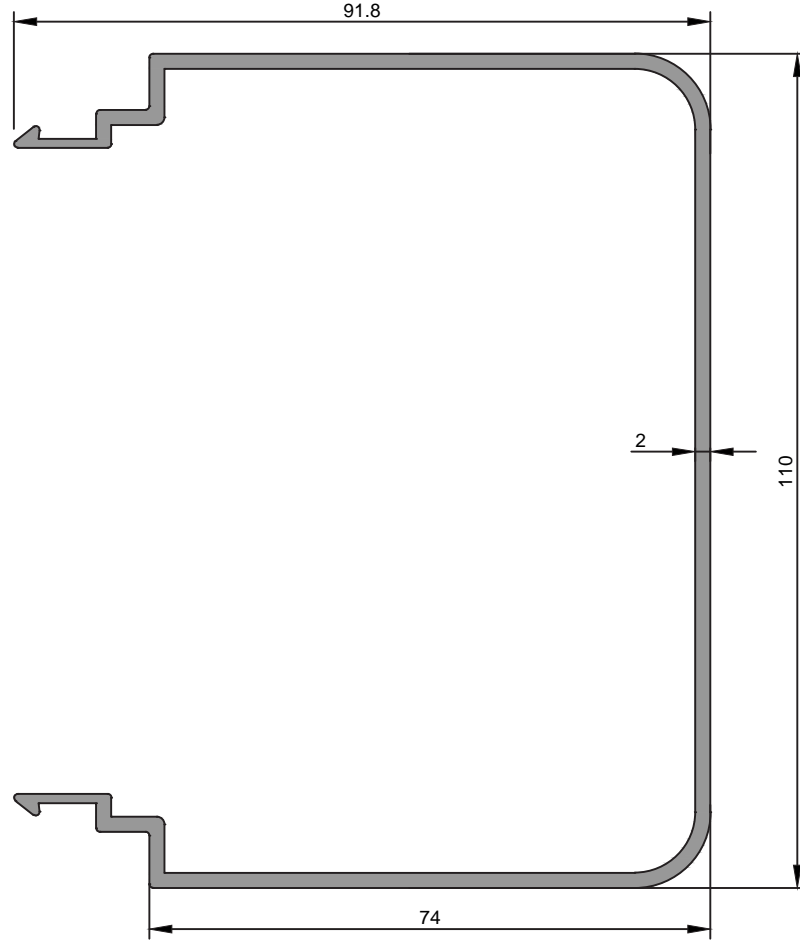

4435
Dikme Kapak Profili
1,606 kg/m
$J_x=122,77 \text{ cm}^4$ $J_y=55,84 \text{ cm}^4$

H2 VERANDA PROFİLLERİ

H2 VERANDA PROFILES

★ Yandaki profil birim ağırlıkları, bilgisayararda hesaplanmış teorik ağırlıklardır.

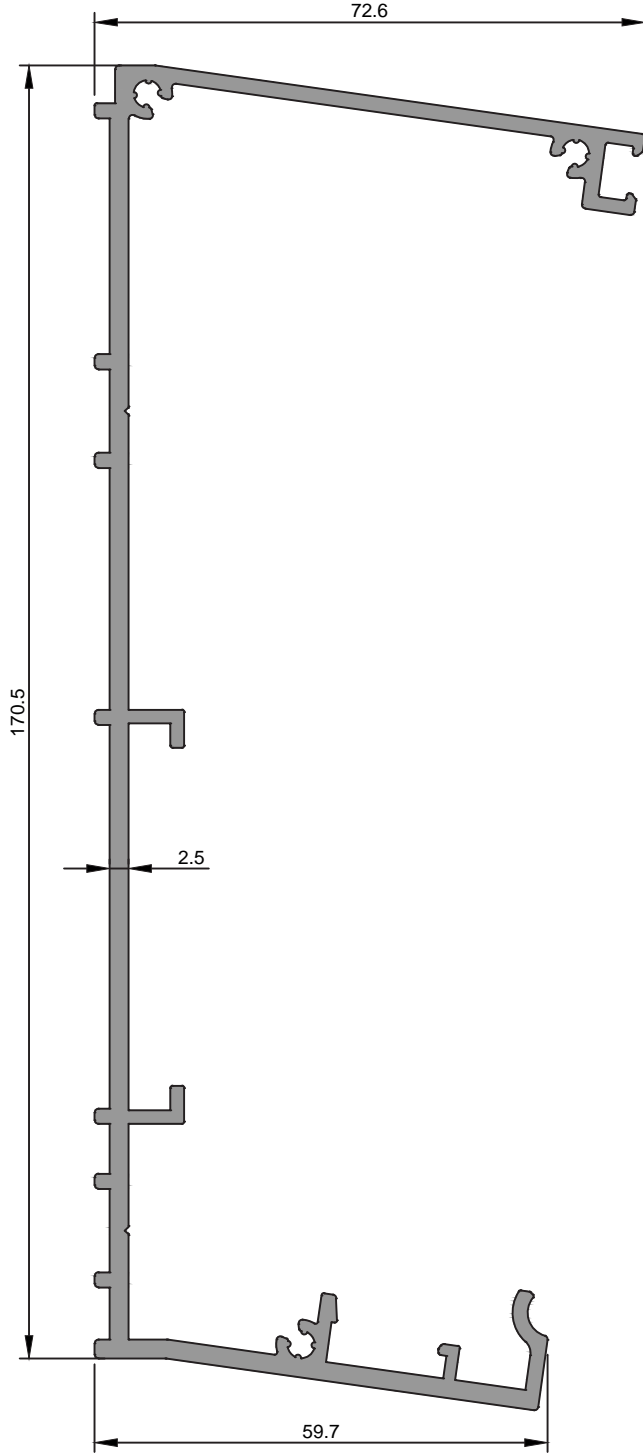

H2 VERANDA PROFİLLERİ

H2 VERANDA PROFILES

★ Yandaki profil birim ağırlıkları, bilgisayarla hesaplanmış teorik ağırlıklardır.

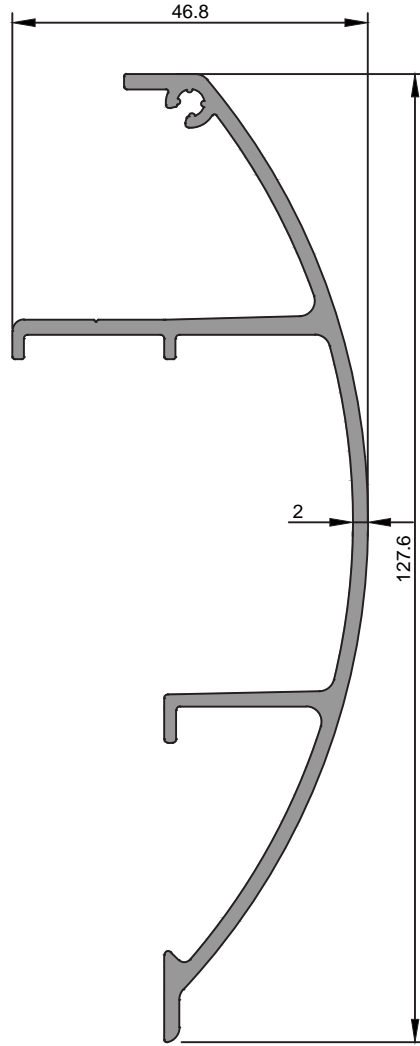

4437
Oluk Kapak Profili
1,250 kg/m
$Jx=60,92 \text{ cm}^4$ $Jy=5,79 \text{ cm}^4$

H2 VERANDA PROFİLLERİ

H2 VERANDA PROFILES

4438

Veranda Profili

0,767 kg/m

$J_x=28,68 \text{ cm}^4$ $J_y=1,70 \text{ cm}^4$

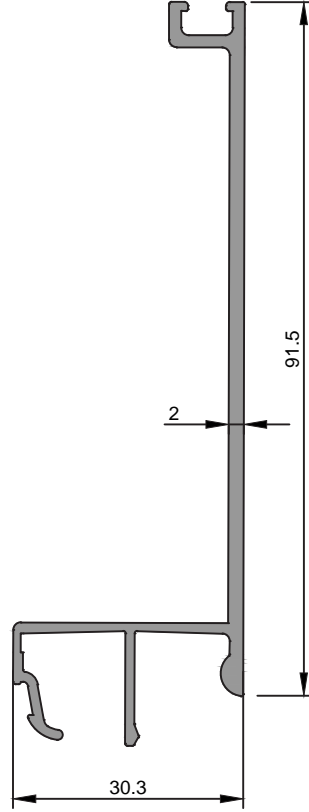

★ Yandaki profil birim ağırlıkları, bilgisayararda hesaplanmış teorik ağırlıklardır.

H2 VERANDA PROFİLLERİ

H2 VERANDA PROFILES

★ Yandaki profil birim ağırlıkları, bilgisayarda hesaplanmış teorik ağırlıklardır.

2972
Yatay Taşıyıcı Profil (86)
1,643 kg/m
$J_x=73,83 \text{ cm}^4$ $J_y=21,32 \text{ cm}^4$

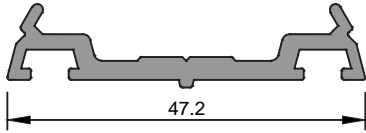
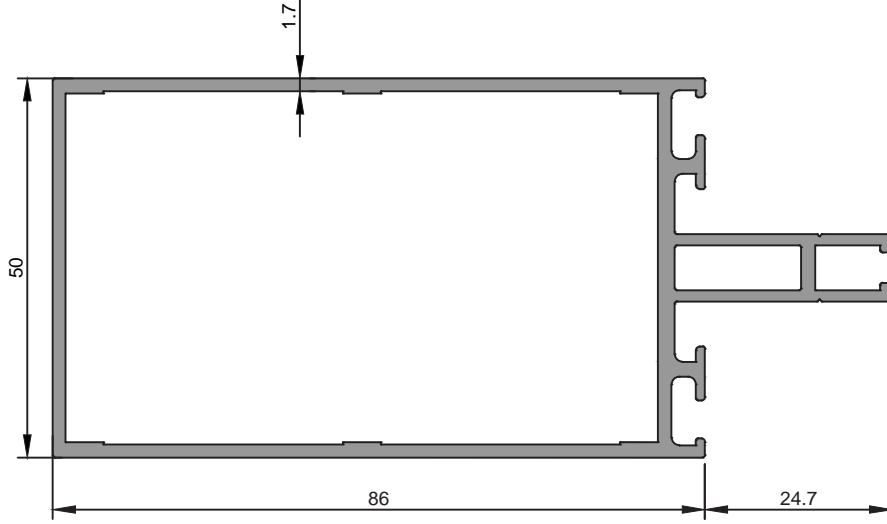

2019
Kapak Altı Profili
0,430 kg/m

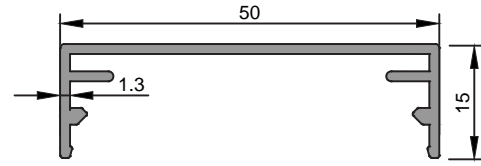

2020
Kapak Profili
0,333 kg/m

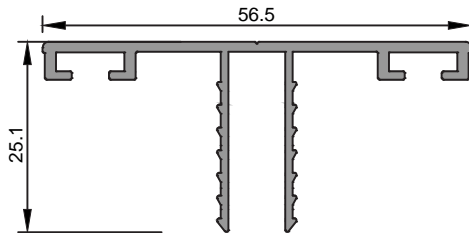

3325
Veranda Profili
0,428 kg/m

H2 VERANDA PROFİLLERİ

H2 VERANDA PROFILES

★ Yandaki profil birim ağırlıkları, bilgisayararda hesaplanmış teorik ağırlıklardır.

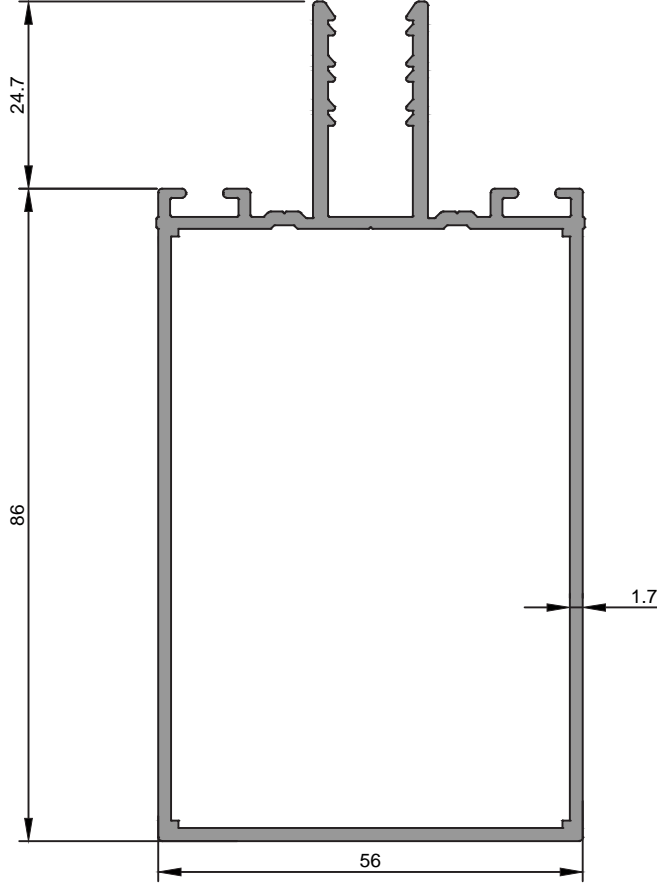

4504
Taşıyıcı Profil(86)
1,672 kg/m
$J_x=79,60 \text{ cm}^4$ $J_y=27,16 \text{ cm}^4$

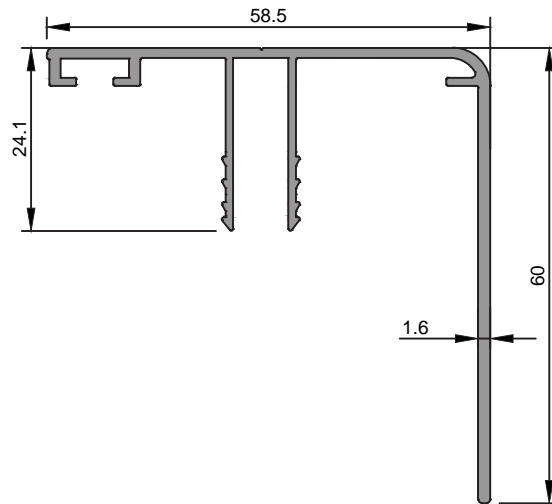

4088
Veranda Profili
0,640 kg/m
$J_x=12,39 \text{ cm}^4$ $J_y=3,19 \text{ cm}^4$

H2 VERANDA PROFİLLERİ

H2 VERANDA PROFILES

★ Yandaki profil birim ağırlıkları, bilgisayarda hesaplanmış teorik ağırlıklardır.

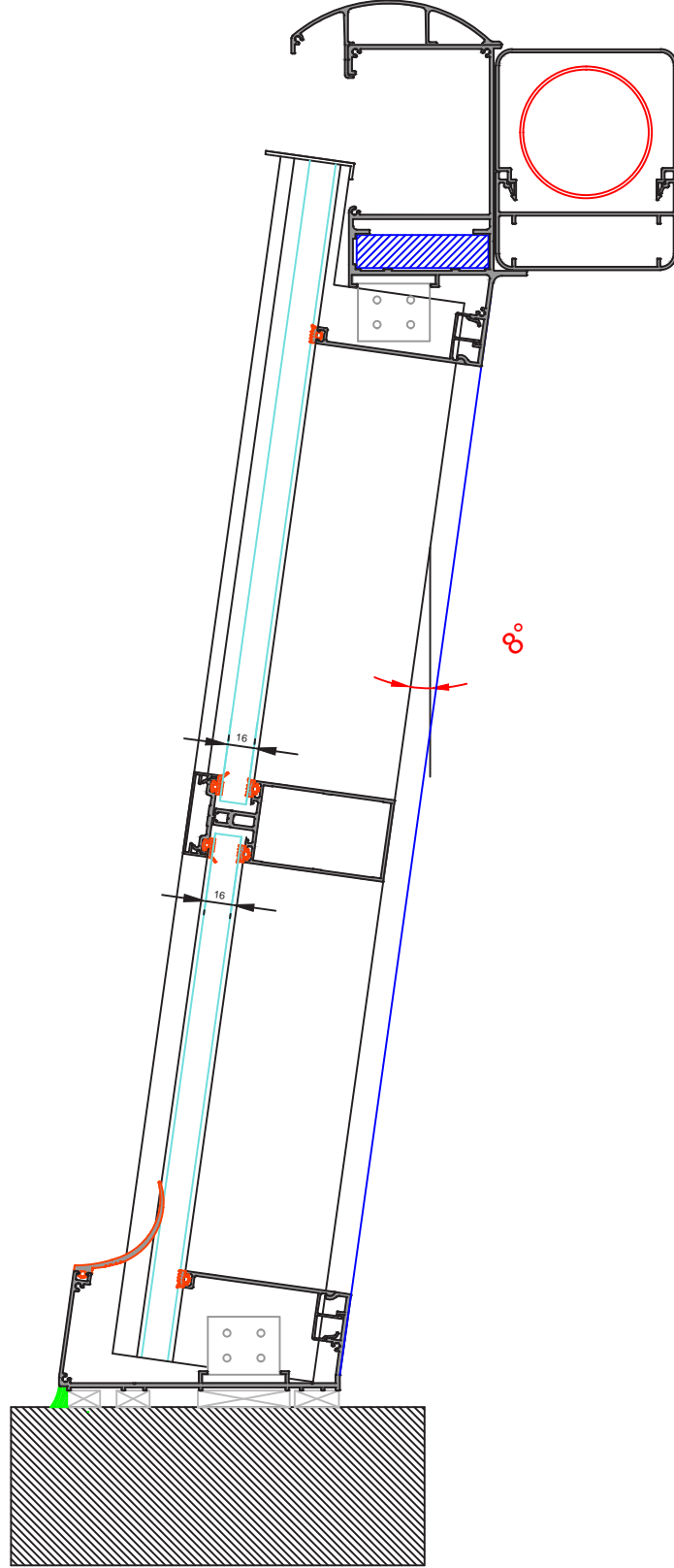

PROFİL KATALOĞU

KOMPOZİT PROFİLLERİ

COMPOSITE PANEL PROFILES













* Profil Ağırlıkları Teorik Olup Teslim Anındaki Ağırlık Geçerlidir

* *Weight of profiles are theoretical, net weight will valid at the time of delivery.*

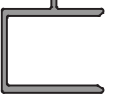
KOMPOZİT PROFİLLERİ

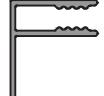
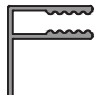
COMPOSITE PANEL PROFILES

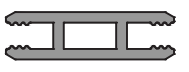
★ Yandaki profil birim ağırlıkları, bilgisayarda hesaplanmış teorik ağırlıklardır.

PROFİL KESİTİ	PROFİL KODU	PROFİL ADI	AĞIRLIK	ATALET MOMENTLERİ		SAYFA NO
				J_x (cm ⁴)	J_y (cm ⁴)	
	1337	Kompozit Profili	0,202 kg/m	0,69	0,04	
	1085	Kompozit Profili	0,238 kg/m	0,77	0,05	
	1764	Kompozit Profili	0,233 kg/m	0,79	0,07	
	1243	Kompozit Profili	0,230 kg/m	0,74	0,07	
	1591	Kompozit Profili	0,205 kg/m	0,63	0,08	
	1633	Kompozit Profili	0,169 kg/m	0,37	0,05	
	1851	Kompozit Profili	0,560 kg/m	2,94	1,72	
	1979	Kompozit Profili	0,520 kg/m	4,83	1,29	
	1188	Kompozit Profili	0,217 kg/m	0,44	0,16	
	1907	Kompozit Profili	0,176 kg/m	0,30	0,10	
	1019	Kompozit Profili	0,163 kg/m	0,47	0,08	
	1159	Kompozit Profili	0,403 kg/m	11,58	0,16	
	1193	Kompozit Profili	0,280 kg/m	1,34	0,60	
	1240	Kompozit Profili	0,123 kg/m	0,15	0,03	

KOMPOZİT PROFİLLERİ

COMPOSITE PANEL PROFILES

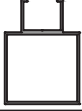
PROFİL KESİTİ	PROFİL KODU	PROFİL ADI	AĞIRLIK	ATALET MOMENTLERİ		SAYFA NO
				J_x (cm ⁴)	J_y (cm ⁴)	
	1018	Kompozit Profili	0,123 kg/m	0,17	0,05	
	1192	Kompozit Profili	1,093 kg/m	20,31	12,57	

★ Yandaki profil birim ağırlıkları, bilgisayarda hesaplanmış teorik ağırlıklardır.

KOMPOZİT PROFİLLERİ

COMPOSITE PANEL PROFILES

★ Yandaki profil birim ağırlıkları, bilgisayarda hesaplanmış teorik ağırlıklardır.

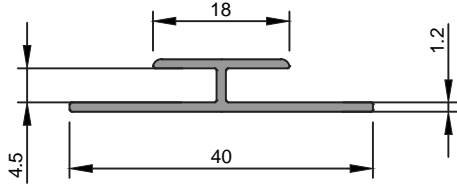

1337
Kompozit Profili
0,202 kg/m
$J_x=0,69 \text{ cm}^4$ $J_y=0,04 \text{ cm}^4$

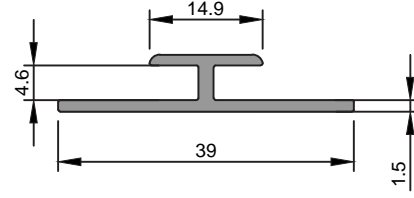

1085
Kompozit Profili
0,238 kg/m
$J_x=0,77 \text{ cm}^4$ $J_y=0,05 \text{ cm}^4$

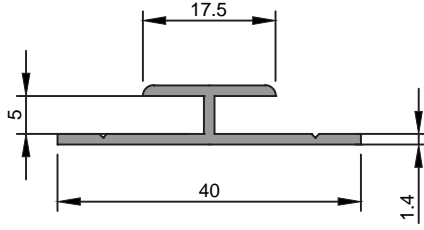

1764
Kompozit Profili
0,233 kg/m
$J_x=0,79 \text{ cm}^4$ $J_y=0,07 \text{ cm}^4$

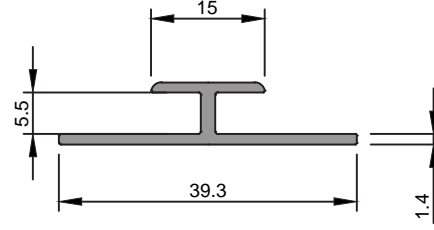

1243
Kompozit Profili
0,230 kg/m
$J_x=0,74 \text{ cm}^4$ $J_y=0,07 \text{ cm}^4$

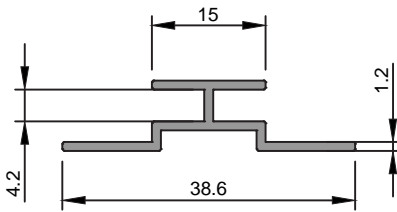

1591
Kompozit Profili
0,205 kg/m
$J_x=0,63 \text{ cm}^4$ $J_y=0,08 \text{ cm}^4$

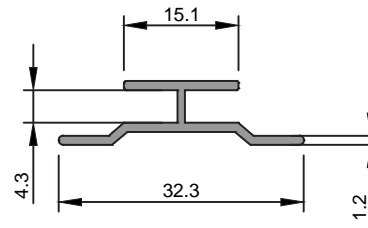

1633
Kompozit Profili
0,169 kg/m
$J_x=0,37 \text{ cm}^4$ $J_y=0,05 \text{ cm}^4$

KOMPOZİT PROFİLLERİ

COMPOSITE PANEL PROFILES

★ Yandaki profil birim ağırlıkları, bilgisayarda hesaplanmış teorik ağırlıklardır.

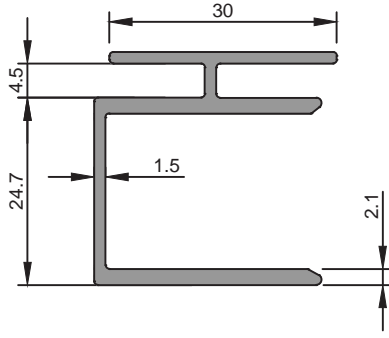

1851
Kompozit Profili
0,560 kg/m
$Jx=2,94 \text{ cm}^4$ $Jy=1,72 \text{ cm}^4$

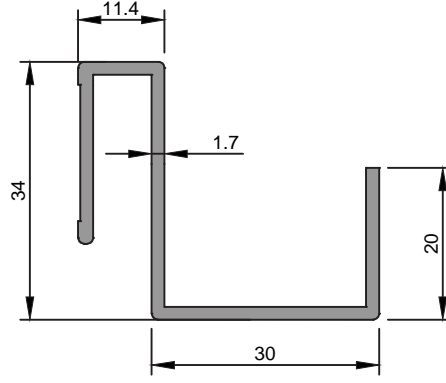

1979
Kompozit Profili
0,520 kg/m
$Jx=4,83 \text{ cm}^4$ $Jy=1,29 \text{ cm}^4$

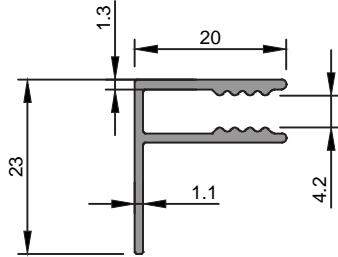

1188
Kompozit Profili
0,217 kg/m
$Jx=0,44 \text{ cm}^4$ $Jy=0,16 \text{ cm}^4$

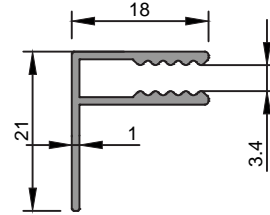

1907
Kompozit Profili
0,176 kg/m
$Jx=0,30 \text{ cm}^4$ $Jy=0,10 \text{ cm}^4$

KOMPOZİT PROFİLLERİ

COMPOSITE PANEL PROFILES

★ Yandaki profil birim ağırlıkları, bilgisayarla hesaplanmış teorik ağırlıklardır.

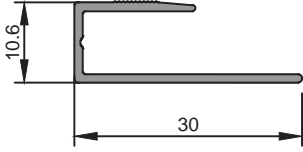

1019
Kompozit Profili
0,163 kg/m
$J_x=0,47 \text{ cm}^4$ $J_y=0,08 \text{ cm}^4$

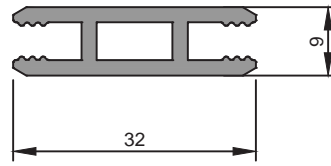

1159
Kompozit Profili
0,403 kg/m
$J_x=11,58 \text{ cm}^4$ $J_y=0,16 \text{ cm}^4$

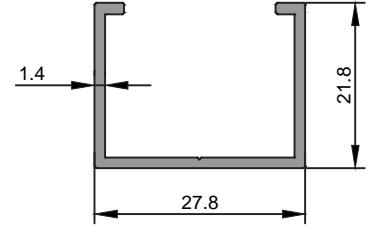

1193
Kompozit Profili
0,280 kg/m
$J_x=1,34 \text{ cm}^4$ $J_y=0,60 \text{ cm}^4$

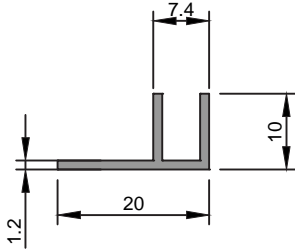

1240
Kompozit Profili
0,123 kg/m
$J_x=0,15 \text{ cm}^4$ $J_y=0,03 \text{ cm}^4$

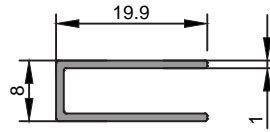

1018
Kompozit Profili
0,123 kg/m
$J_x=0,17 \text{ cm}^4$ $J_y=0,05 \text{ cm}^4$

KOMPOZİT PROFİLLERİ

COMPOSITE PANEL PROFILES

★ Yandaki profil birim ağırlıkları, bilgisayarda hesaplanmış teorik ağırlıklardır.

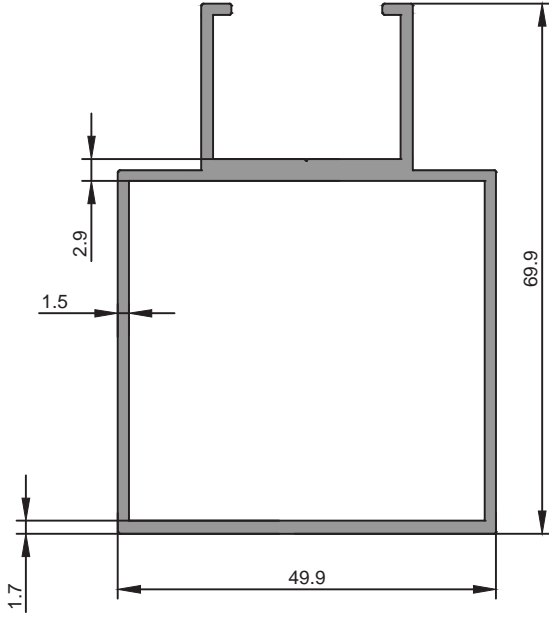

1192
Kompozit Profili
1,093 kg/m
$J_x=20,31 \text{ cm}^4$ $J_y=12,57 \text{ cm}^4$

PROFİL KATALOĞU

KÜPEŞTE PROFİLLERİ

HANDRAILS PROFILES

* Profil Ağırlıkları Teorik Olup Teslim Anındaki Ağırlık Geçerlidir

* *Weight of profiles are theoretical, net weight will valid at the time of delivery.*

KÜPEŞTE PROFİLLERİ

HANDRAILS PROFILES















★ Yandaki profil birim ağırlıkları, bilgisayarda hesaplanmış teorik ağırlıklardır.

PROFİL KESİTİ	PROFİL KODU	PROFİL ADI	AĞIRLIK	ATALET MOMENTLERİ		SAYFA NO
				J_x (cm ⁴)	J_y (cm ⁴)	
	1361	40x1,3 Küpeşte Profili	0,815 kg/m	
	1020	40x1,6 Küpeşte Profili	0,912 kg/m	
	1251	40x2 Küpeşte Profili	1,064 kg/m	
	1021	40x1,5 Küpeşte Profili	0,870 kg/m	
	2052	40x1,5 Küpeşte Profili	0,700 kg/m	
	1359	40x1,6 Küpeşte Profili	0,688 kg/m	
	1014	40x1,6 Küpeşte Profili	0,780 kg/m	
	1314	39,2x1,7 Küpeşte Profili	0,893 kg/m	
	1690	50,3x1,6 Küpeşte Profili	0,935 kg/m	
	1194	30x1,5 Küpeşte Profili	0,519 kg/m	
	1252	30x1,8 Küpeşte Profili	0,672 kg/m	
	2014	40x1,3 Küpeşte Profili	0,781 kg/m	
	2095	40x1,3 Küpeşte Profili	0,780 kg/m	
	1169	40x2 Küpeşte Profili	0,647 kg/m	

KÜPEŞTE PROFİLLERİ

HANDRAILS PROFILES













★ Yandaki profil birim ağırlıkları, bilgisayarda hesaplanmış teorik ağırlıklardır.

PROFİL KESİTİ	PROFİL KODU	PROFİL ADI	AĞIRLIK	ATALET MOMENTLERİ		SAYFA NO
				J_x (cm ⁴)	J_y (cm ⁴)	
	1926	40x2,5 Küpeşte Profili	0,798 kg/m	
	2640	35x1,3 Küpeşte Profili	0,373 kg/m	
	2641	35x1,5 Küpeşte Profili	0,428 kg/m	
	2736	35x2 Küpeşte Profili	0,562 kg/m	
	1064	Kapak Profili	0,060 kg/m	
	1315	Kapak Profili	0,064 kg/m	
	2015	Kapak Profili	0,079 kg/m	
	1191	Kapak Profili	0,085 kg/m	
	2194	35x1,3 Küpeşte Profili	0,817 kg/m	
	1173	30x2 Küpeşte Profili	0,477 kg/m	
	1048	30x3 Küpeşte Profili	0,690 kg/m	
	2639	19x1 Küpeşte Profili	0,153 kg/m	
	2519	19x1,2 Küpeşte Profili	0,182 kg/m	
	1804	16x1 Küpeşte Profili	0,128 kg/m	

KÜPEŞTE PROFİLLERİ

HANDRAILS PROFILES

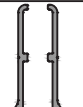
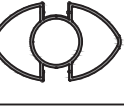
★ Yandaki profil birim ağırlıkları, bilgisayarda hesaplanmış teorik ağırlıklardır.

PROFİL KESİTİ	PROFİL KODU	PROFİL ADI	AĞIRLIK	ATALET MOMENTLERİ		SAYFA NO
				J_x (cm ⁴)	J_y (cm ⁴)	
	1606	16x1,2 Küpeşte Profili	0,151 kg/m	
	1063	16x1,5 Küpeşte Profili	0,185 kg/m	
	1011	16x2 Küpeşte Profili	0,238 kg/m	
	1308	16x4 Küpeşte Profili	0,409 kg/m	
	1172	16x5 Küpeşte Profili	0,468 kg/m	
	1605	Küpeşte Profili	1,043 kg/m	
	1317	Küpeşte Profili	1,266 kg/m	
	2055	Küpeşte Profili	0,834 kg/m	
	2054	Küpeşte Profili	0,832 kg/m	
	1986	Küpeşte Profili	1,238 kg/m	
	1985	Küpeşte Profili	1,414 kg/m	
	2070	Küpeşte Profili	0,770 kg/m	
	1005	Küpeşte Profili	0,973 kg/m	
	1162	Küpeşte Profili	1,092 kg/m	

KÜPEŞTE PROFİLLERİ

HANDRAILS PROFILES

★ Yandaki profil birim ağırlıkları, bilgisayarda hesaplanmış teorik ağırlıklardır.

PROFİL KESİTİ	PROFİL KODU	PROFİL ADI	AĞIRLIK	ATALET MOMENTLERİ		SAYFA NO
				J_x (cm ⁴)	J_y (cm ⁴)	
	1244	Küpeşte Profili	1,116 kg/m	
	1819	Küpeşte Profili	0,854 kg/m	
	1027	Küpeşte Profili	2,365 kg/m	
	1157	Küpeşte Profili	1,528 kg/m	
	1286	Küpeşte Profili	3,027 kg/m	
	1275	Küpeşte Profili	0,240 kg/m	
	1646	Küpeşte Profili	0,942 kg/m	
	1007	Küpeşte Profili	0,892 kg/m	
	1045	Küpeşte Profili	0,709 kg/m	
	1820	Küpeşte Profili	0,511 kg/m	
	1023	Küpeşte Profili	1,023 kg/m	
	1024	Küpeşte Profili	1,367 kg/m	
	1177	Küpeşte Profili	0,968 kg/m	
	1070	Küpeşte Profili	0,803 kg/m	

KÜPEŞTE PROFİLLERİ

HANDRAILS PROFILES









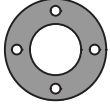

★ Yandaki profil birim ağırlıkları, bilgisayarda hesaplanmış teorik ağırlıklardır.

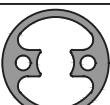
PROFİL KESİTİ	PROFİL KODU	PROFİL ADI	AĞIRLIK	ATALET MOMENTLERİ		SAYFA NO
				J_x (cm ⁴)	J_y (cm ⁴)	
	1072	Küpeşte Profili	0,737 kg/m	
	1071	Küpeşte Profili	0,383 kg/m	
	1003	Küpeşte Profili	1,508 kg/m	
	1615	Küpeşte Profili	0,306 kg/m	
	1163	Küpeşte Profili	0,243 kg/m	
	1013	Küpeşte Profili	2,649 kg/m	
	1028	Küpeşte Profili	2,524 kg/m	
	1818	Küpeşte Profili	1,502 kg/m	
	1930	Küpeşte Profili	1,465 kg/m	
	1174	Küpeşte Profili	1,412 kg/m	
	1000	Küpeşte Profili	8,003 kg/m	
	1001	Küpeşte Profili	6,648 kg/m	
	1647	Küpeşte Profili	1,055 kg/m	
	1077	Küpeşte Profili	1,587 kg/m	

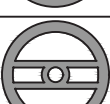
KÜPEŞTE PROFİLLERİ

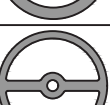
HANDRAILS PROFILES

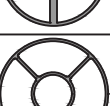

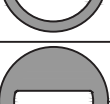







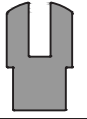

★ Yandaki profil birim ağırlıkları, bilgisayarda hesaplanmış teorik ağırlıklardır.

PROFİL KESİTİ	PROFİL KODU	PROFİL ADI	AĞIRLIK	ATALET MOMENTLERİ		SAYFA NO
				J_x (cm ⁴)	J_y (cm ⁴)	
	1379	Küpeşte Profili	4,039 kg/m	
	1073	Küpeşte Profili	5,389 kg/m	
	1917	Küpeşte Profili	3,910 kg/m	
	1817	Küpeşte Profili	2,430 kg/m	
	1009	Küpeşte Profili	3,070 kg/m	
	1075	Küpeşte Profili	3,628 kg/m	
	1098	Küpeşte Profili	4,144 kg/m	
	1219	Küpeşte Profili	2,675 kg/m	
	1178	Küpeşte Profili	2,750 kg/m	
	1008	Küpeşte Profili	2,773 kg/m	
	1374	Küpeşte Profili	1,653 kg/m	
	1319	Küpeşte Profili	1,295 kg/m	
	1164	Küpeşte Profili	2,460 kg/m	
	1183	Küpeşte Profili	4,530 kg/m	

KÜPEŞTE PROFİLLERİ



HANDRAILS PROFILES

★ Yandaki profil birim ağırlıkları, bilgisayarda hesaplanmış teorik ağırlıklardır.

PROFİL KESİTİ	PROFİL KODU	PROFİL ADI	AĞIRLIK	ATALET MOMENTLERİ		SAYFA NO
				J_x (cm ⁴)	J_y (cm ⁴)	
	2060	Küpeşte Profili	0,463 kg/m	
	2030	Küpeşte Profili	3,078 kg/m	
	1002	Küpeşte Profili	2,986 kg/m	
	1160	Küpeşte Profili	3,018 kg/m	
	1161	Küpeşte Profili	3,349 kg/m	
	1260	Küpeşte Profili	2,678 kg/m	
	1190	Küpeşte Profili	4,065 kg/m	
	1065	Küpeşte Profili	10,11 kg/m	
	1189	Küpeşte Profili	3,506 kg/m	
	1025	Küpeşte Profili	3,516 kg/m	
	1026	Küpeşte Profili	2,636 kg/m	
	1732	Küpeşte Profili	3,609 kg/m	
	1038	Küpeşte Profili	2,140 kg/m	
	1039	Küpeşte Profili	2,201 kg/m	

KÜPEŞTE PROFİLLERİ

HANDRAILS PROFILES

PROFİL KESİTİ	PROFİL KODU	PROFİL ADI	AĞIRLIK	ATALET MOMENTLERİ		SAYFA NO
				J_x (cm ⁴)	J_y (cm ⁴)	
	4047	Küpeşte Profili	1,533 kg/m	
	4360	Küpeşte Profili	0,450 kg/m	
				
				
				
				
				
				
				
				
				
				
				
				

★ Yandaki profil birim ağırlıkları, bilgisayarla hesaplanmış teorik ağırlıklardır.

KÜPEŞTE PROFİLLERİ

HANDRAILS PROFILES

★ Yandaki profil birim ağırlıkları, bilgisayarda hesaplanmış teorik ağırlıklardır.

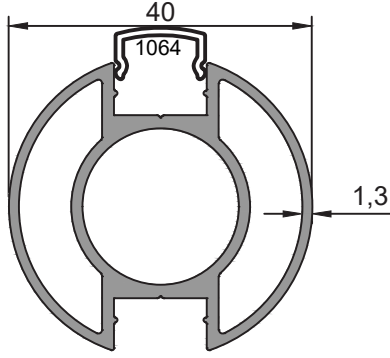

1361
Küpeşte Profili
0,815 kg/m

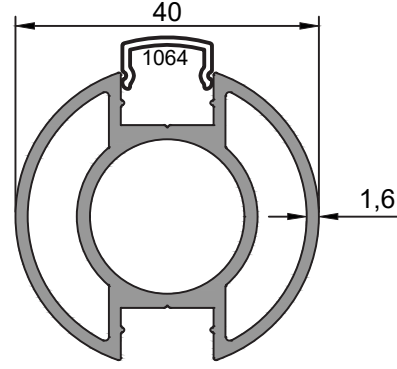

1020
Küpeşte Profili
0,912 kg/m

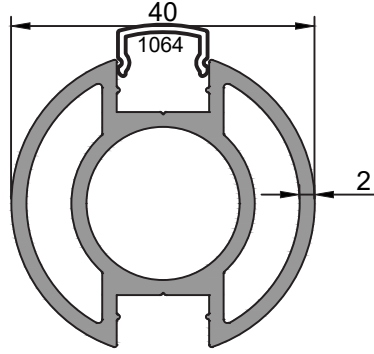

1251
Küpeşte Profili
1,064 kg/m

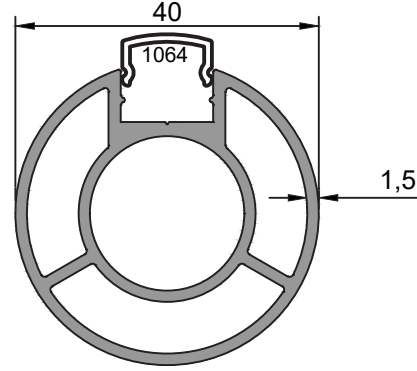

1021
Küpeşte Profili
0,870 kg/m

KÜPEŞTE PROFİLLERİ

HANDRAILS PROFILES

★ Yandaki profil birim ağırlıkları, bilgisayarda hesaplanmış teorik ağırlıklardır.

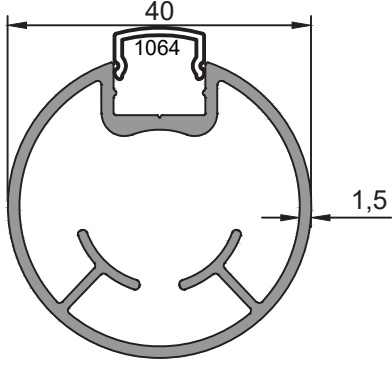

2052
Küpeşte Profili
0,700 kg/m

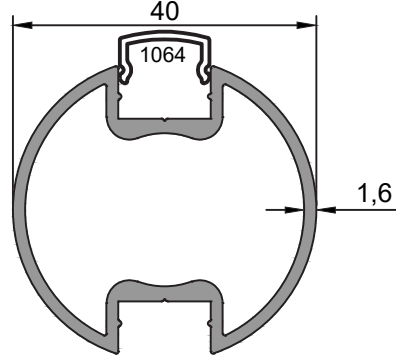

1359
Küpeşte Profili
0,688 kg/m

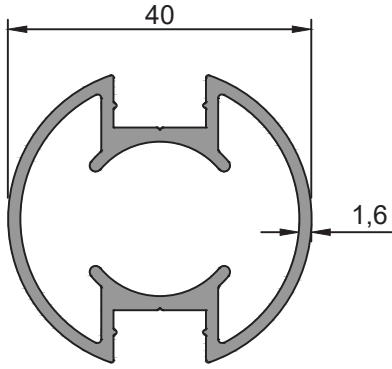

1014
Küpeşte Profili
0,780 kg/m

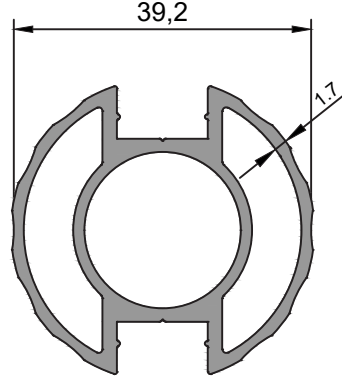

1314
Küpeşte Profili
0,893 kg/m

KÜPEŞTE PROFİLLERİ

HANDRAILS PROFILES

★ Yandaki profil birim ağırlıkları, bilgisayararda hesaplanmış teorik ağırlıklardır.

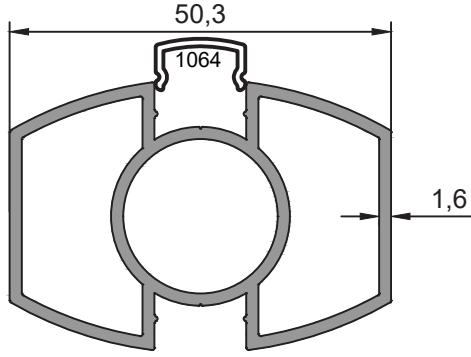

1690
Küpeşte Profili
0,935 kg/m

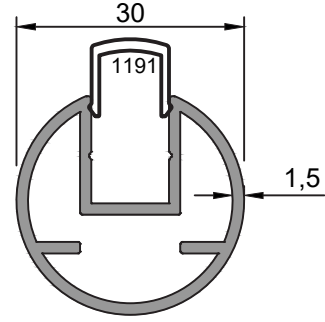

1194
Küpeşte Profili
0,519 kg/m

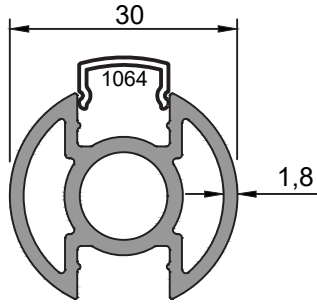

1252
Küpeşte Profili
0,672 kg/m

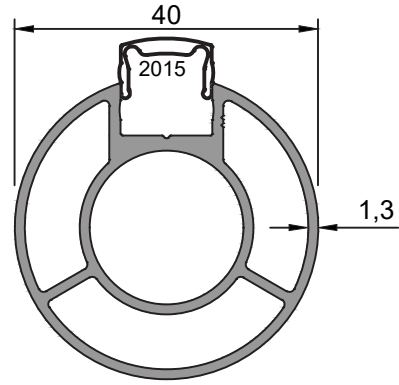

2014
Küpeşte Profili
0,781 kg/m

KÜPEŞTE PROFİLLERİ

HANDRAILS PROFILES

★ Yandaki profil birim ağırlıkları, bilgisayarda hesaplanmış teorik ağırlıklardır.

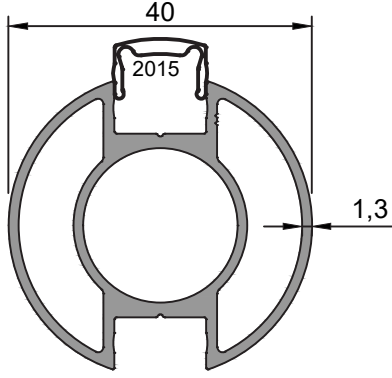

2095
Küpeşte Profili
0,780 kg/m

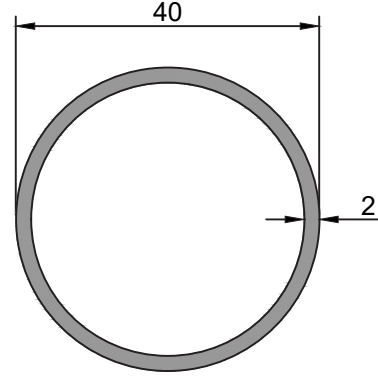

1169
Küpeşte Profili
0,647 kg/m

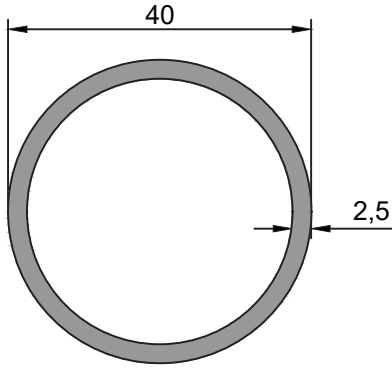

1926
Küpeşte Profili
0,798 kg/m

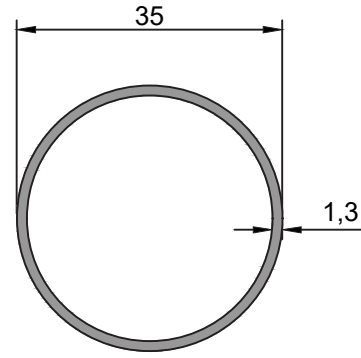

2640
Küpeşte Profili
0,373 kg/m

KÜPEŞTE PROFİLLERİ

HANDRAILS PROFILES

★ Yandaki profil birim ağırlıkları, bilgisayarla hesaplanmış teorik ağırlıklardır.

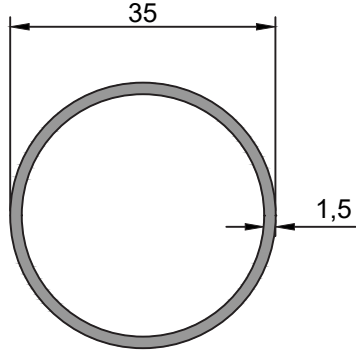

2641
Küpeşte Profili
0,428 kg/m

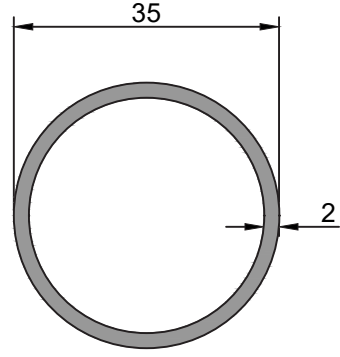

2736
Küpeşte Profili
0,562 kg/m

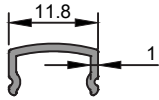

1064
0,060 kg/m

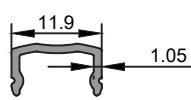

1315
0,064 kg/m

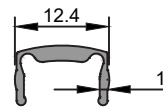

2015
0,079 kg/m

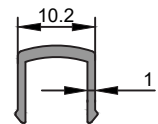

1191
0,085 kg/m

KÜPEŞTE PROFİLLERİ

HANDRAILS PROFILES

★ Yandaki profil birim ağırlıkları, bilgisayarda hesaplanmış teorik ağırlıklardır.

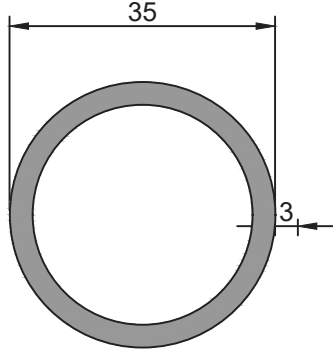

2194
Küpeşte Profili
0,817 kg/m

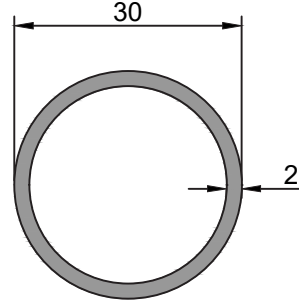

1173
Küpeşte Profili
0,477 kg/m

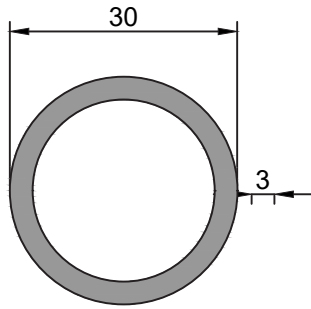

1048
Küpeşte Profili
0,690 kg/m

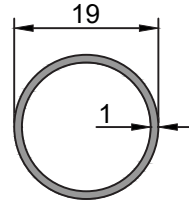

2639
Küpeşte Profili
0,153 kg/m

KÜPEŞTE PROFİLLERİ

HANDRAILS PROFILES

★ Yandaki profil birim ağırlıkları, bilgisayararda hesaplanmış teorik ağırlıklardır.

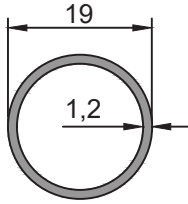

2519
Küpeşte Profili
0,182 kg/m

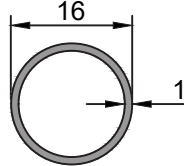

1804
Küpeşte Profili
0,128 kg/m

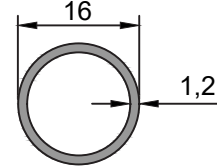

1606
Küpeşte Profili
0,151 kg/m

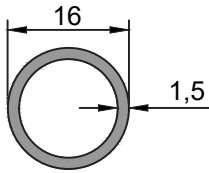

1063
Küpeşte Profili
0,185 kg/m

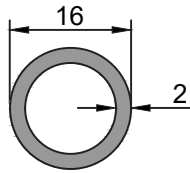

1011
Küpeşte Profili
0,238 kg/m

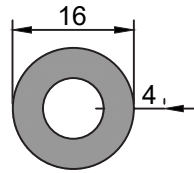

1308
Küpeşte Profili
0,409 kg/m

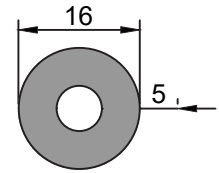

1172
Küpeşte Profili
0,468 kg/m

KÜPEŞTE PROFİLLERİ HANDRAILS PROFILES

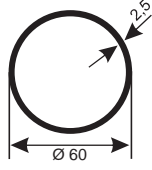

HA - 3001

Ø 60 Boru
Ø 60 Tube
1219 gr/mt

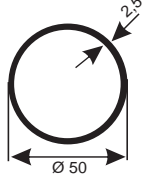

HA - 3002

Ø 50 Boru
Ø 50 Tube
1007 gr/mt

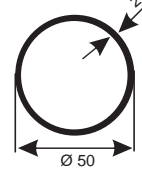

HA - 3002A

Ø 50 Boru
Ø 50 Tube
814 gr/mt

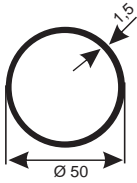

HA - 3002B

Ø 50 Boru
Ø 50 Tube
619 gr/mt

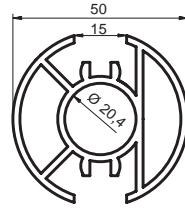

HA - 3002C

Ø 50 Dikme 2 Kanallı
Ø 50 Struts 2 Canals
1730 gr/mt

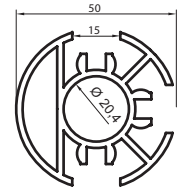
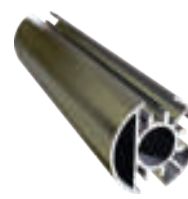

HA - 3002D

Ø 50 Dikme 3 Kanallı
Ø 50 Struts 3 Canals
1690 gr/mt

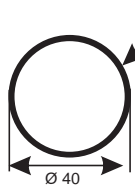

HA - 3003

Ø 40 Boru
Ø 40 Pipe
795 gr/mt

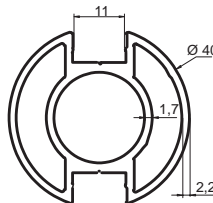

HA - 3004

Ø 40 Dikme
Ø 40 Struts 2 Canals
1100 gr/mt

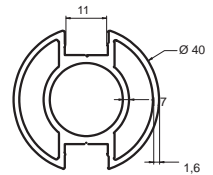
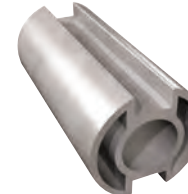

HA - 3004A

Ø 40 Dikme
Ø 40 Struts 2 Canals
918 gr/mt

★ Yandaki profil birim ağırlıkları, bilgisayarda hesaplanmış teorik ağırlıklardır.

KÜPEŞTE PROFİLLERİ

HANDRAILS PROFILES

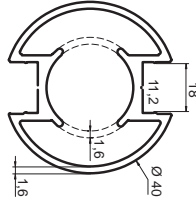

HA - 3004B

Ø 40 Boş Dikme
Ø 40 Hollow Struts 2
Canals
785 gr/mt

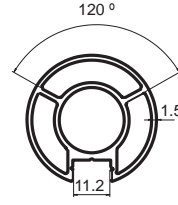
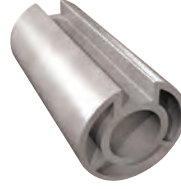

HA - 3004C

Ø 40 Dikme Tek Kanallı
Ø 40 Struts Single Canal
877 gr/mt

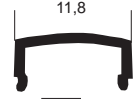
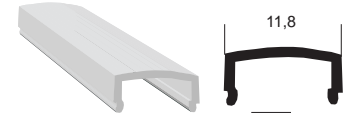

HA - 3005

Dikme Kanal Kapağı
Struts Canal Cover
60 gr/mt

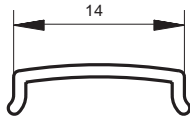
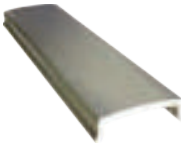

HA - 3005A

Ø 30 Dikme Kanal Kapağı
Ø 30 Struts Canal Cover
55 gr/mt

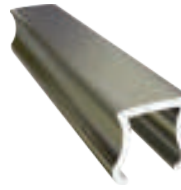

HA - 3005B

Ø 50 Dikme Kanal Kapağı
Ø 50 Struts Canal Cover
135 gr/mt

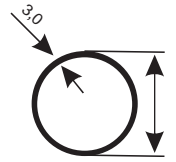
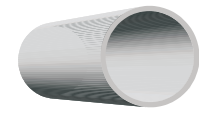

HA - 3006

Ø 30 Boru
Ø 30 Pipe
687 gr/mt

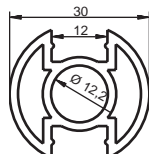

HA - 3006A

Ø 30 Dikme
Ø 30 Struts
2 Canals 680 gr/mt

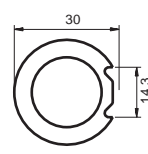

HA - 3006B

Ø 30 Dikme
Tek Kanallı
Ø 30 Struts Single Canal 975 gr/mt

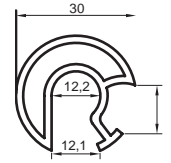

HA - 3006C

Ø 30 Dikme 90°
Ø 30 Struts 2 Canals
90°
620 gr/mt

★ Yandaki profil birim ağırlıkları, bilgisayarda hesaplanmış teorik ağırlıklardır.

KÜPEŞTE PROFİLLERİ

HANDRAILS PROFILES

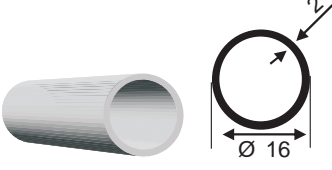

HA - 3007

Ø 16 Boru
Ø 16 Pipe
230 gr/mt

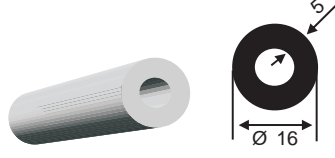

HA - 3007A

Ø 16 Boru
Ø 16 Pipe
470 gr/mt

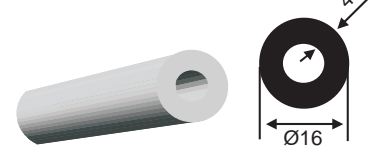

HA - 3007B

Ø 16 Boru
Ø 16 Pipe
410 gr/mt

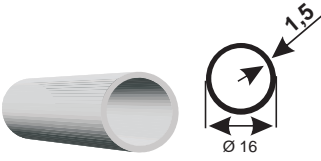

HA - 3007C

Ø 16 Boru
Ø 16 Pipe
182 gr/mt



HA - 3001A

Ø 12 Kare Profil
Ø 12 Square Pipe
206 gr/mt
Özel İmalat

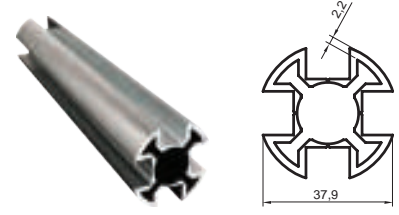

HA - 3004D

Ø 40 Dikme 4 Kanallı
Ø 40 Struts 4 Canals
999 gr/mt

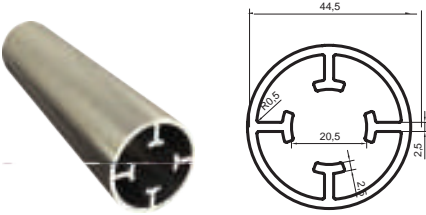

HA - 3004E

Ø 40 Kanalsız Dikme
Ø 40 Struts No Canal
1301 gr/mt

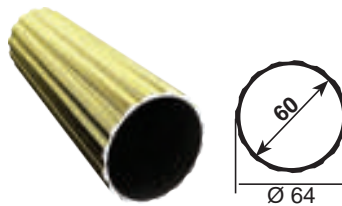

HA - 3036

Ø 60 Büyük Dekorlu Tapa Dikmesi
Ø 60 Decorative Pipe
1500 gr/mt

★ Yandaki profil birim ağırlıkları, bilgisayarda hesaplanmış teorik ağırlıklardır.

KÜPEŞTE PROFİLLERİ

HANDRAILS PROFILES

★ Yandaki profil birim ağırlıkları, bilgisayarla hesaplanmış teorik ağırlıklardır.

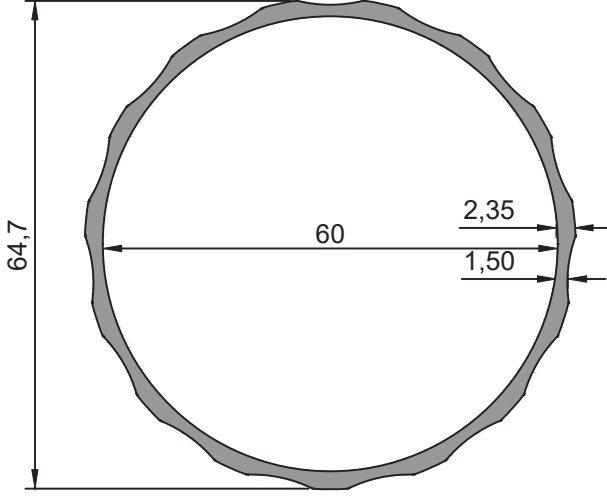

1605
Küpeşte Profili
1,043 kg/m

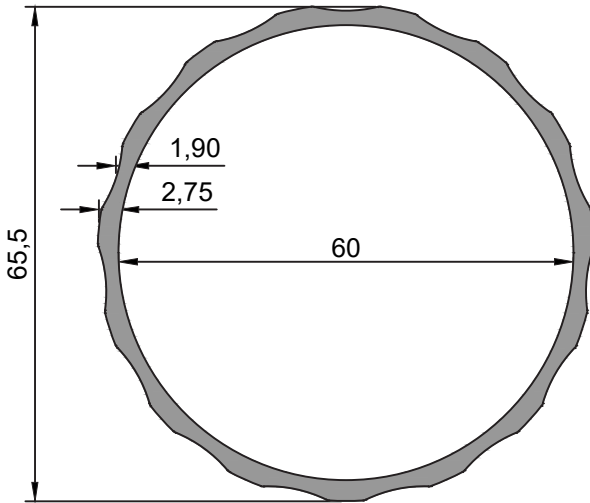

1317
Küpeşte Profili
1,266 kg/m

KÜPEŞTE PROFİLLERİ

HANDRAILS PROFILES

★ Yandaki profil birim ağırlıkları, bilgisayarda hesaplanmış teorik ağırlıklardır.

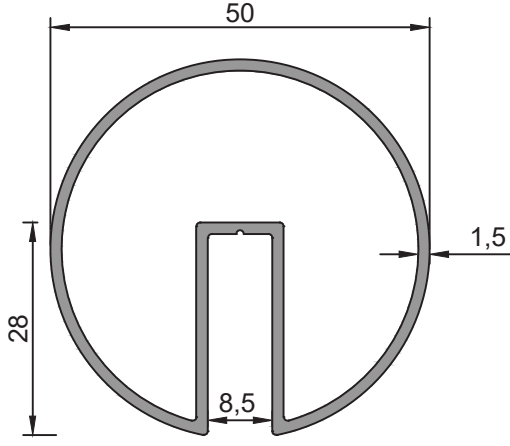

2055
Küpeşte Profili
0,834 kg/m

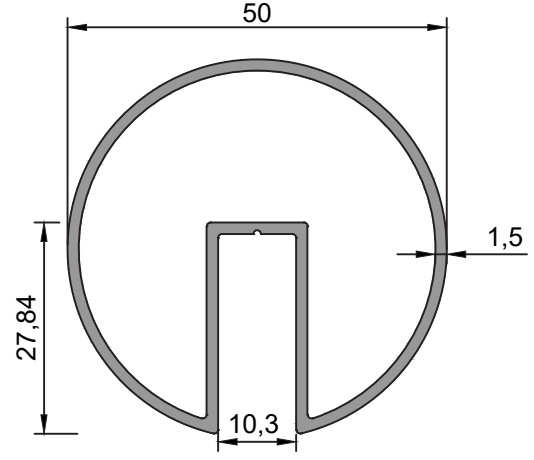

2054
Küpeşte Profili
0,832 kg/m

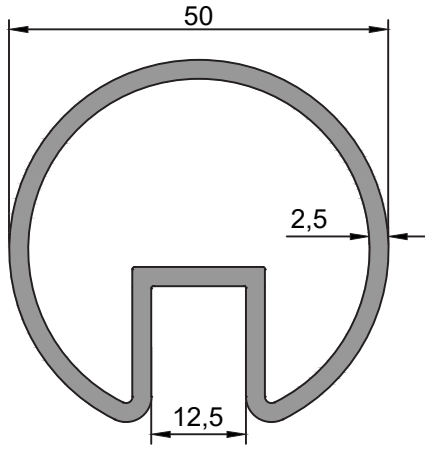

1986
Küpeşte Profili
1,238 kg/m

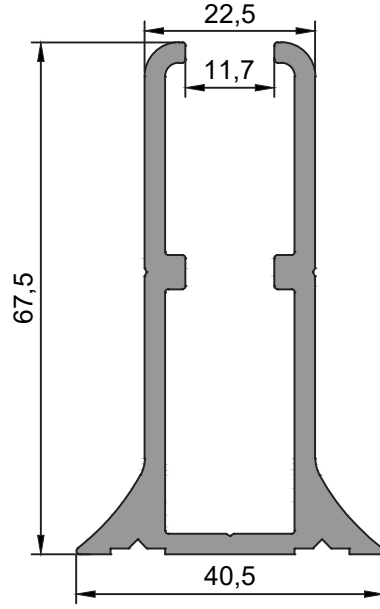

1985
Küpeşte Profili
1,414 kg/m

KÜPEŞTE PROFİLLERİ

HANDRAILS PROFILES

★ Yandaki profil birim ağırlıkları, bilgisayarda hesaplanmış teorik ağırlıklardır.

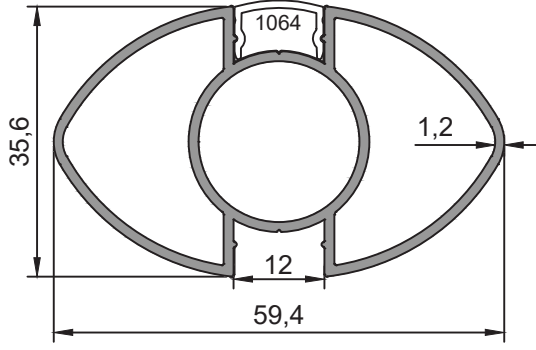

2070
Küpeşte Profili
0,770 kg/m

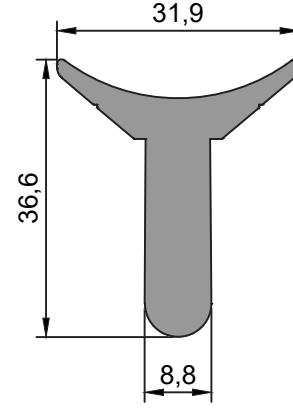

1005
Küpeşte Profili
0,973 kg/m

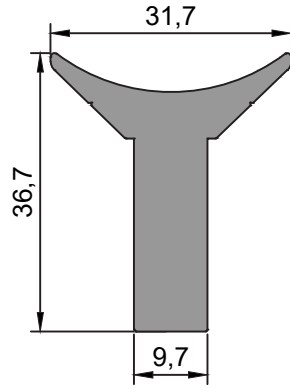

1162
Küpeşte Profili
1,092 kg/m

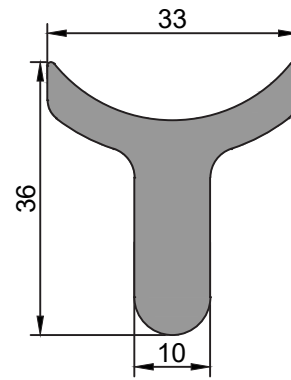

1244
Küpeşte Profili
1,116 kg/m

KÜPEŞTE PROFİLLERİ

HANDRAILS PROFILES

★ Yandaki profil birim ağırlıkları, bilgisayarda hesaplanmış teorik ağırlıklardır.

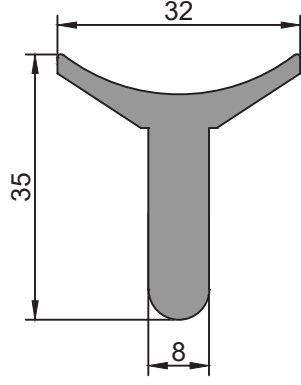

1819
Küpeşte Profili
0,854 kg/m

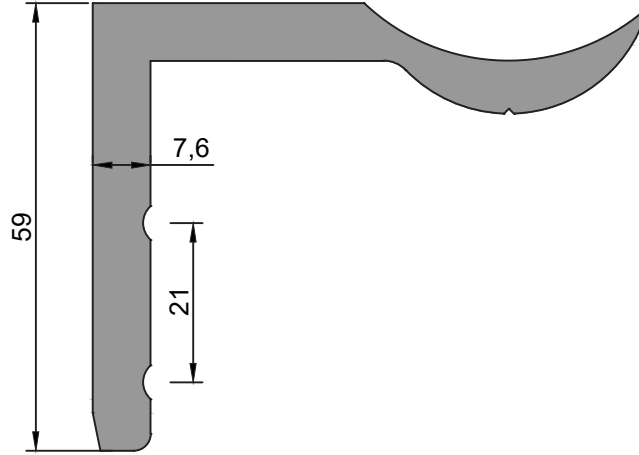

1027
Küpeşte Profili
2,365 kg/m

KÜPEŞTE PROFİLLERİ

HANDRAILS PROFILES

★ Yandaki profil birim ağırlıkları, bilgisayarda hesaplanmış teorik ağırlıklardır.

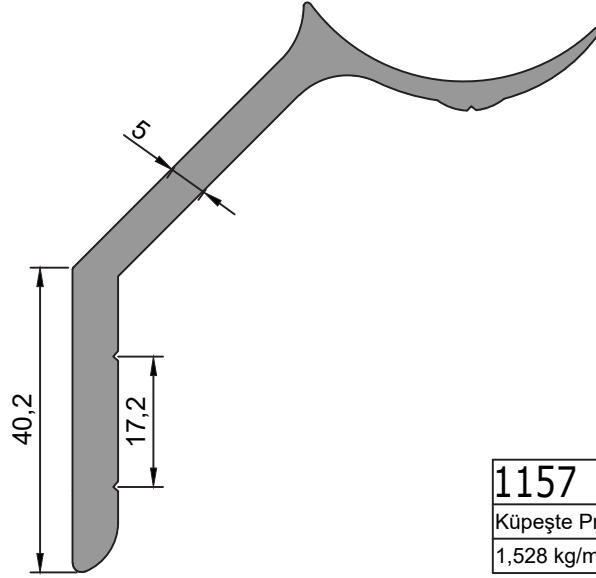

1157
Küpeşte Profili
1,528 kg/m

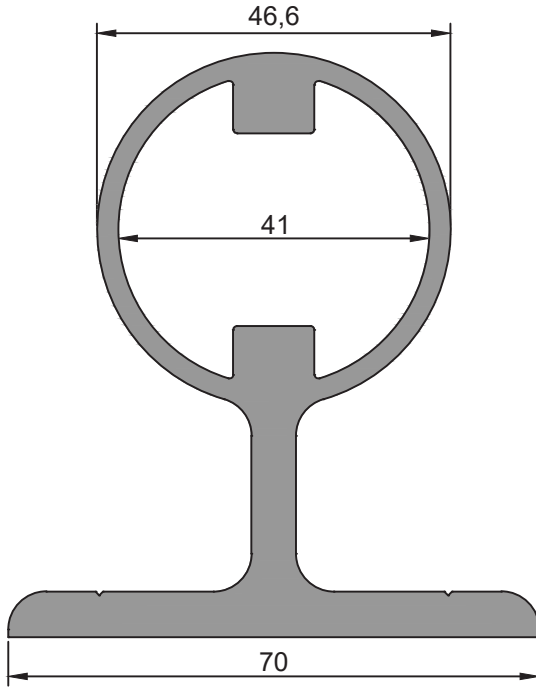

1286
Küpeşte Profili
3,027 kg/m

KÜPEŞTE PROFİLLERİ

HANDRAILS PROFILES

★ Yandaki profil birim ağırlıkları, bilgisayarda hesaplanmış teorik ağırlıklardır.

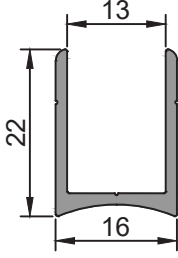

1275
Küpeşte Profili
0,240 kg/m

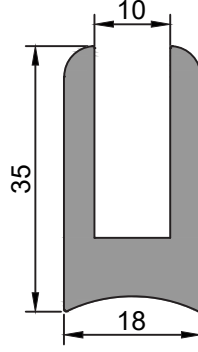

1646
Küpeşte Profili
0,942 kg/m

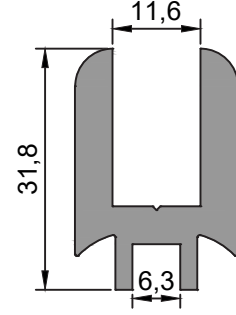

1007
Küpeşte Profili
0,892 kg/m

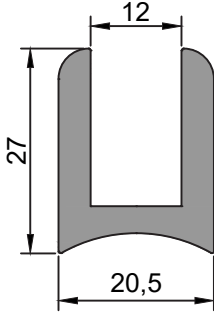

1045
Küpeşte Profili
0,709 kg/m

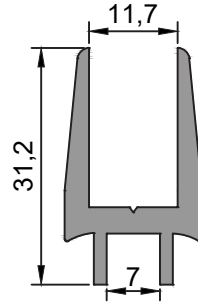

1820
Küpeşte Profili
0,511 kg/m

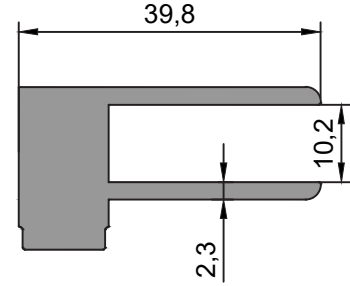

1023
Küpeşte Profili
1,023 kg/m

KÜPEŞTE PROFİLLERİ

HANDRAILS PROFILES

★ Yandaki profil birim ağırlıkları, bilgisayarda hesaplanmış teorik ağırlıklardır.

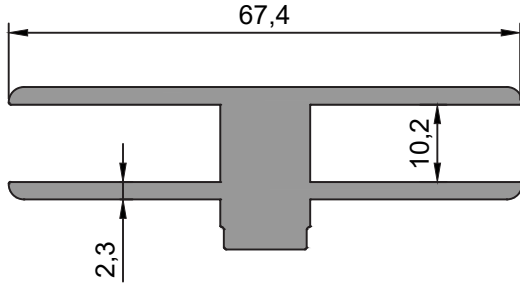

1024
Küpeşte Profili
1,367 kg/m

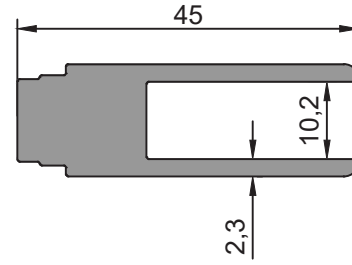

1177
Küpeşte Profili
0,968 kg/m

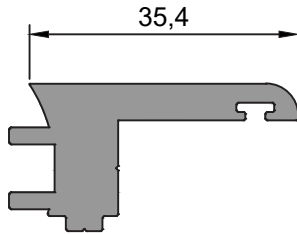

1070
Küpeşte Profili
0,803 kg/m

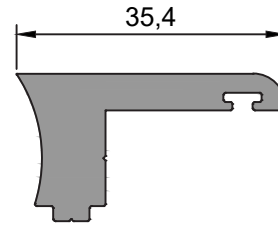

1072
Küpeşte Profili
0,737 kg/m

KÜPEŞTE PROFİLLERİ

HANDRAILS PROFILES

★ Yandaki profil birim ağırlıkları, bilgisayarda hesaplanmış teorik ağırlıklardır.

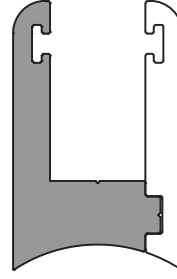
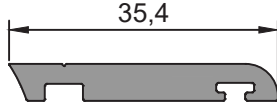

1071
Küpeşte Profili
0,383 kg/m

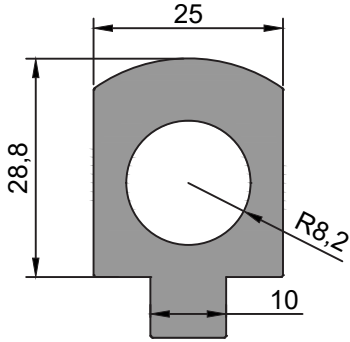

1003
Küpeşte Profili
1,508 kg/m

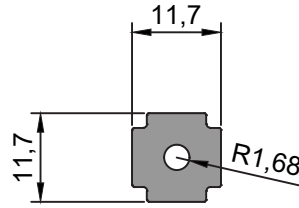

1615
Küpeşte Profili
0,306 kg/m

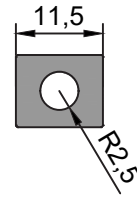

1163
Küpeşte Profili
0,243 kg/m

KÜPEŞTE PROFİLLERİ

HANDRAILS PROFILES

★ Yandaki profil birim ağırlıkları, bilgisayarda hesaplanmış teorik ağırlıklardır.

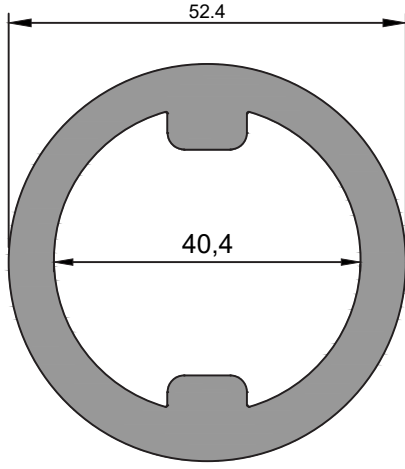

1013
Küpeşte Profili
2,649 kg/m

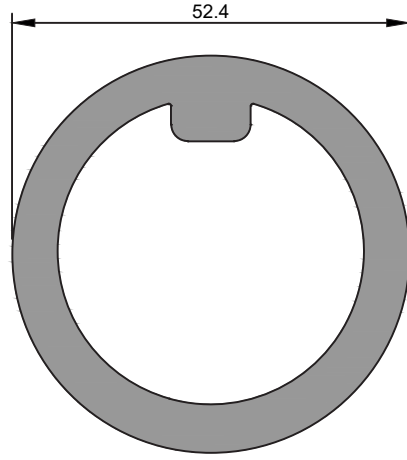

1028
Küpeşte Profili
2,524 kg/m

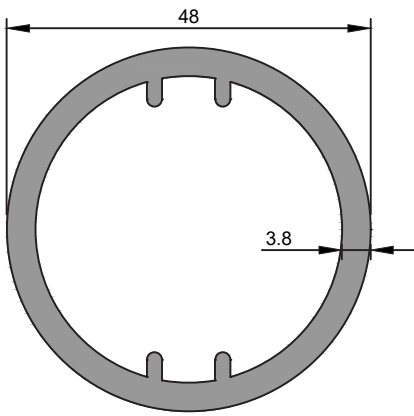

1818
Küpeşte Profili
1,502 kg/m

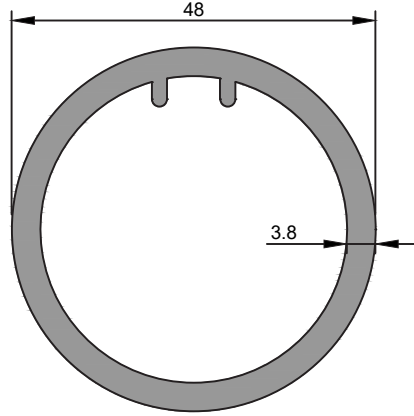

1930
Küpeşte Profili
1,465 kg/m

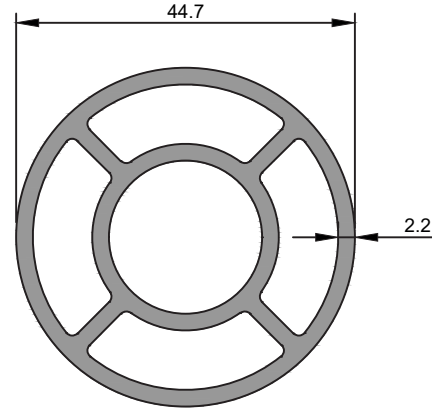

1174
Küpeşte Profili
1,412 kg/m

KÜPEŞTE PROFİLLERİ

HANDRAILS PROFILES

★ Yandaki profil birim ağırlıkları, bilgisayarda hesaplanmış teorik ağırlıklardır.

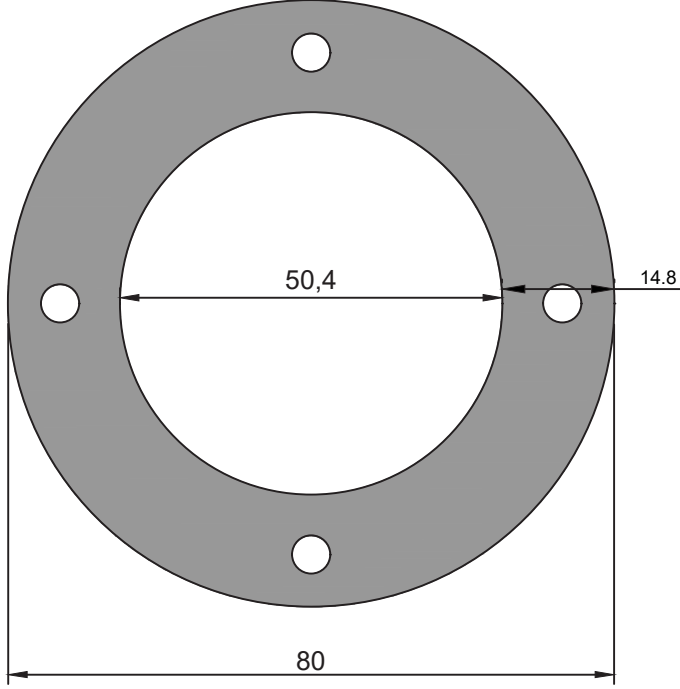

1000
Küpeşte Profili
8,003 kg/m

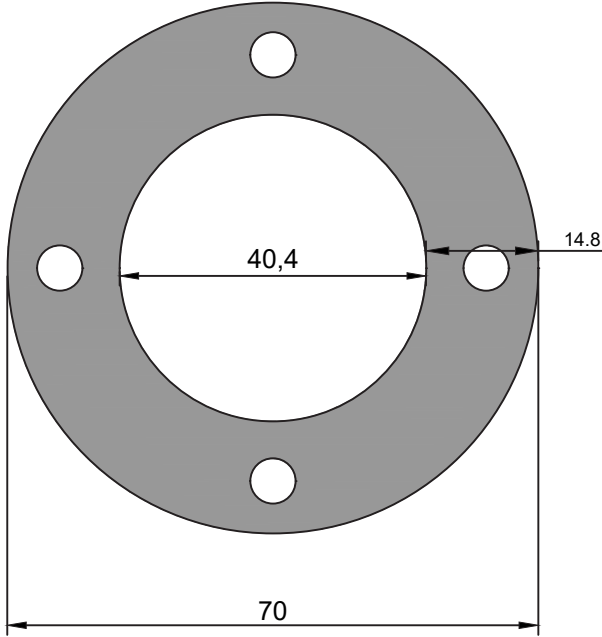

1001
Küpeşte Profili
6,648 kg/m

KÜPEŞTE PROFİLLERİ

HANDRAILS PROFILES

★ Yandaki profil birim ağırlıkları, bilgisayarda hesaplanmış teorik ağırlıklardır.

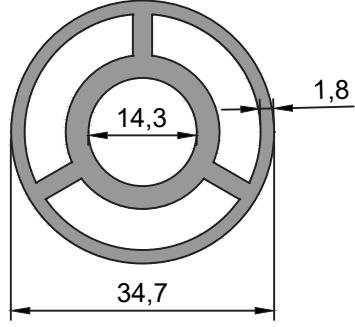

1647
Küpeşte Profili
1,055 kg/m

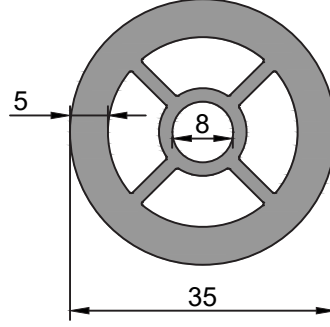

1077
Küpeşte Profili
1,587 kg/m

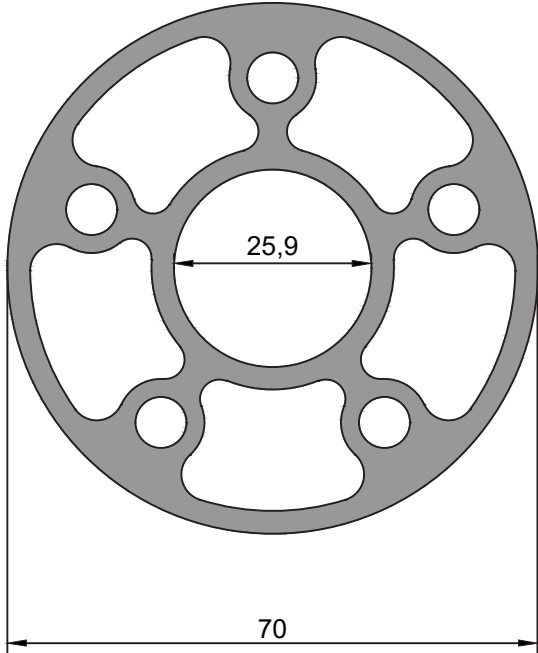

1379
Küpeşte Profili
4,039 kg/m

KÜPEŞTE PROFİLLERİ

HANDRAILS PROFILES

★ Yandaki profil birim ağırlıkları, bilgisayarda hesaplanmış teorik ağırlıklardır.

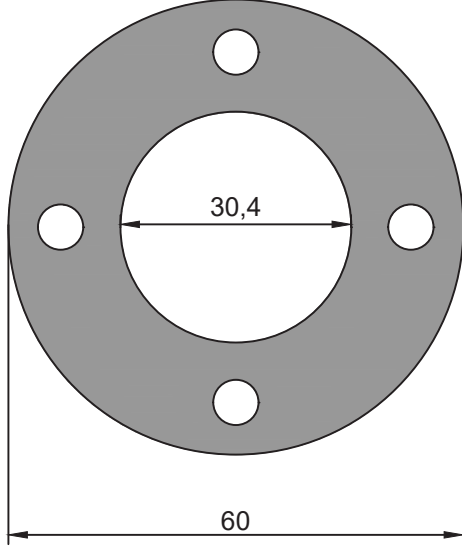

1073
Küpeşte Profili
5,389 kg/m

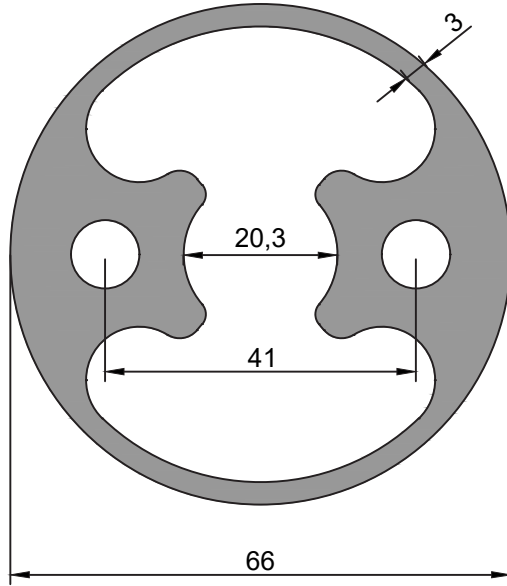

1917
Küpeşte Profili
3,910 kg/m

KÜPEŞTE PROFİLLERİ

HANDRAILS PROFILES

★ Yandaki profil birim ağırlıkları, bilgisayarla hesaplanmış teorik ağırlıklardır.

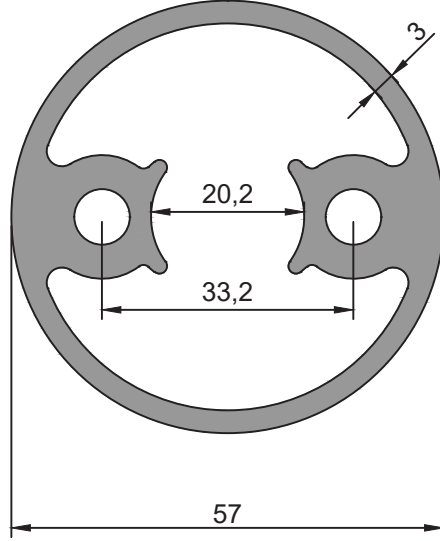

1817
Küpeşte Profili
2,430 kg/m

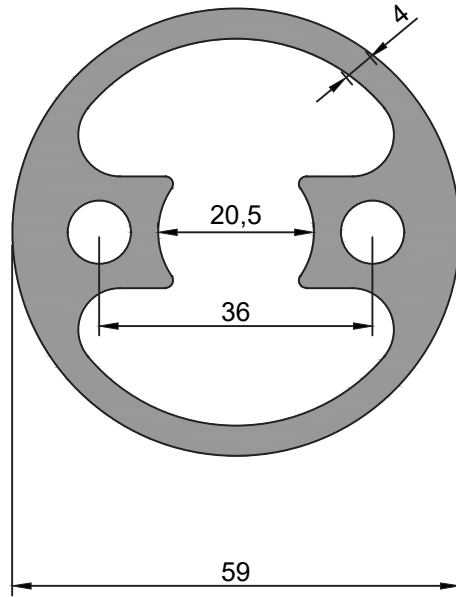

1009
Küpeşte Profili
3,070 kg/m

KÜPEŞTE PROFİLLERİ

HANDRAILS PROFILES

★ Yandaki profil birim ağırlıkları, bilgisayarda hesaplanmış teorik ağırlıklardır.

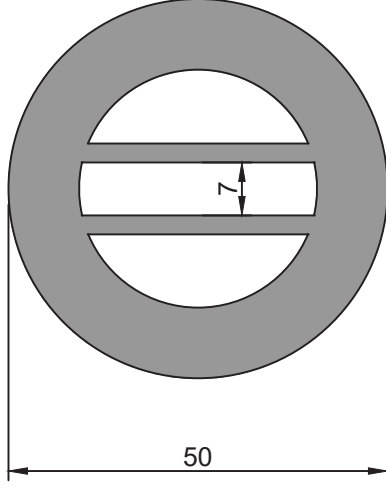

1075
Küpeşte Profili
3,628 kg/m

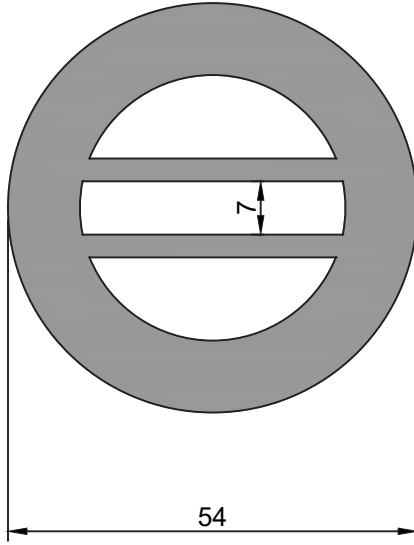

1098
Küpeşte Profili
4,144 kg/m

KÜPEŞTE PROFİLLERİ

HANDRAILS PROFILES

★ Yandaki profil birim ağırlıkları, bilgisayarda hesaplanmış teorik ağırlıklardır.

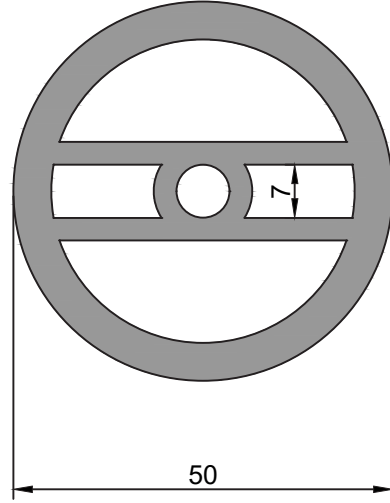

1219
Küpeşte Profili
2,675 kg/m

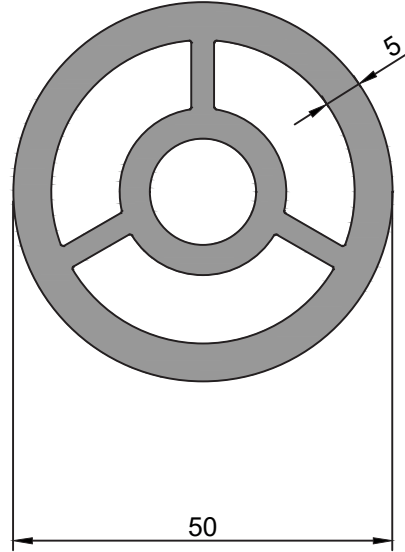

1178
Küpeşte Profili
2,750 kg/m

KÜPEŞTE PROFİLLERİ

HANDRAILS PROFILES

★ Yandaki profil birim ağırlıkları, bilgisayarda hesaplanmış teorik ağırlıklardır.

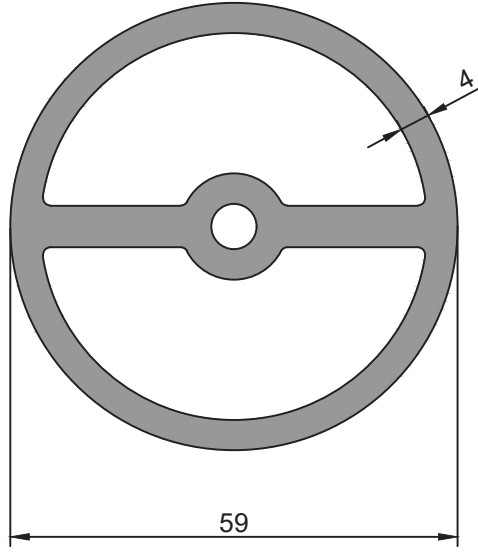

1008
Küpeşte Profili
2,773 kg/m

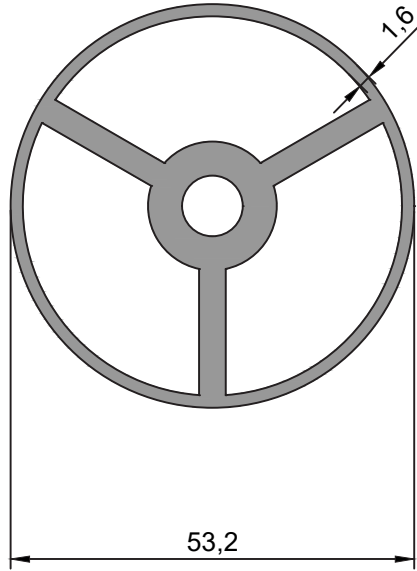

1374
Küpeşte Profili
1,653 kg/m

KÜPEŞTE PROFİLLERİ

HANDRAILS PROFILES

★ Yandaki profil birim ağırlıkları, bilgisayarla hesaplanmış teorik ağırlıklardır.

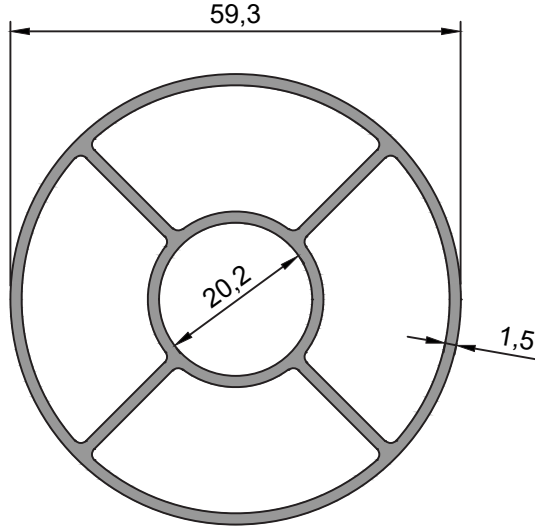

1319
Küpeşte Profili
1,295 kg/m

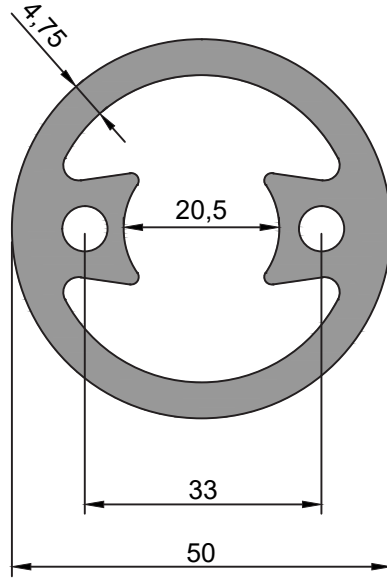

1164
Küpeşte Profili
2,460 kg/m

KÜPEŞTE PROFİLLERİ

HANDRAILS PROFILES

★ Yandaki profil birim ağırlıkları, bilgisayarda hesaplanmış teorik ağırlıklardır.

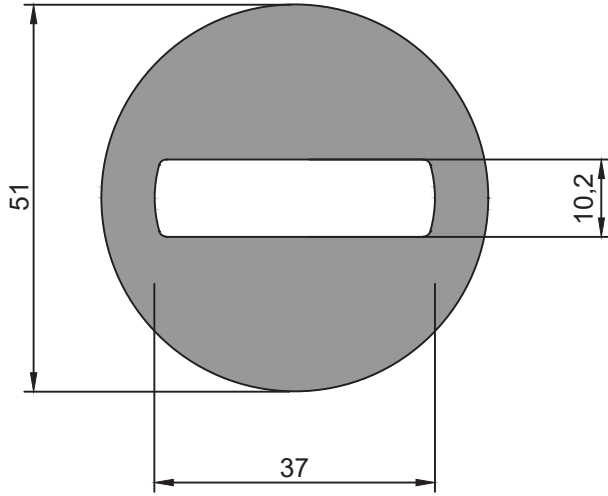

1183
Küpeşte Profili
4,530 kg/m

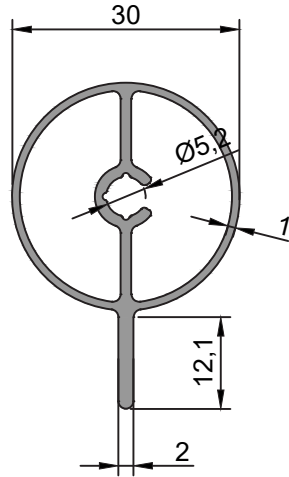

2060
Küpeşte Profili
0,463 kg/m

KÜPEŞTE PROFİLLERİ

HANDRAILS PROFILES

★ Yandaki profil birim ağırlıkları, bilgisayararda hesaplanmış teorik ağırlıklardır.

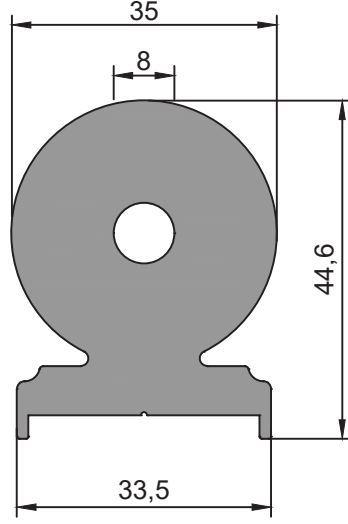

2030
Küpeşte Profili
3,078 kg/m

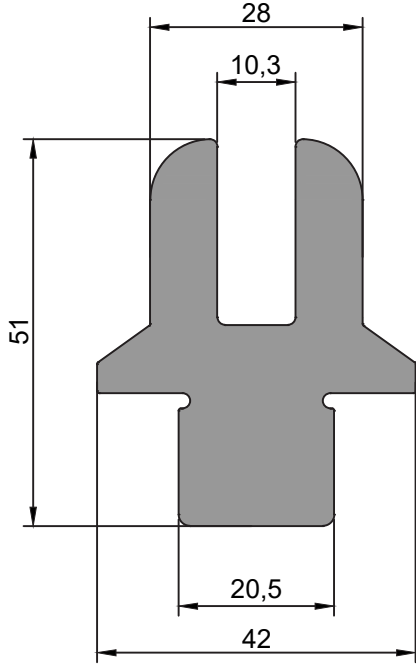

1002
Küpeşte Profili
2,986 kg/m

KÜPEŞTE PROFİLLERİ

HANDRAILS PROFILES

★ Yandaki profil birim ağırlıkları, bilgisayarda hesaplanmış teorik ağırlıklardır.

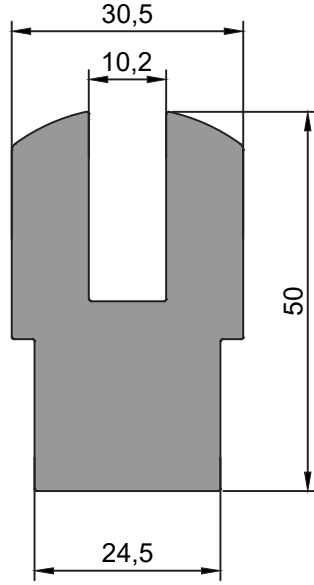

1160
Küpeşte Profili
3,018 kg/m

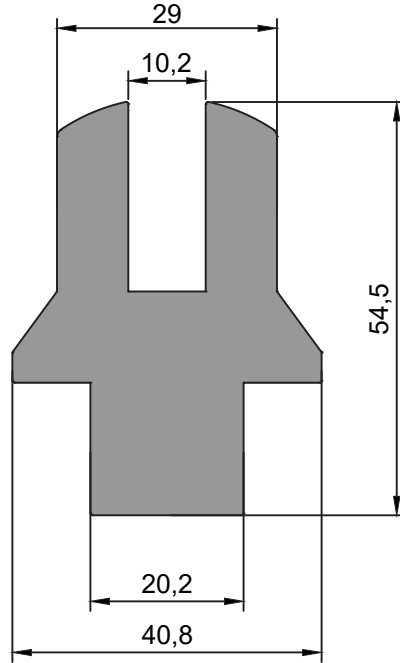

1161
Küpeşte Profili
3,349 kg/m

KÜPEŞTE PROFİLLERİ

HANDRAILS PROFILES

★ Yandaki profil birim ağırlıkları, bilgisayarla hesaplanmış teorik ağırlıklardır.

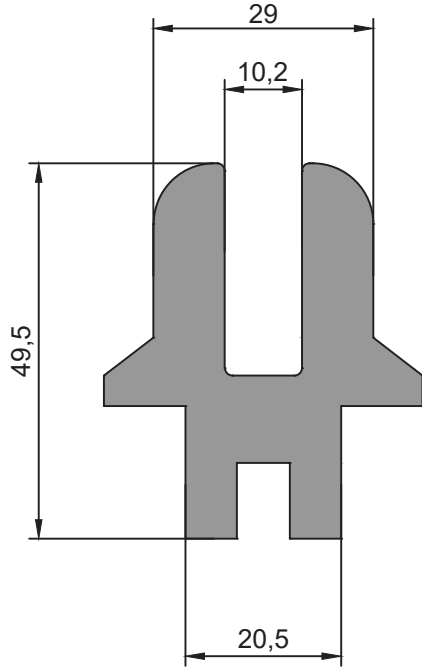

1260
Küpeşte Profili
2,678 kg/m

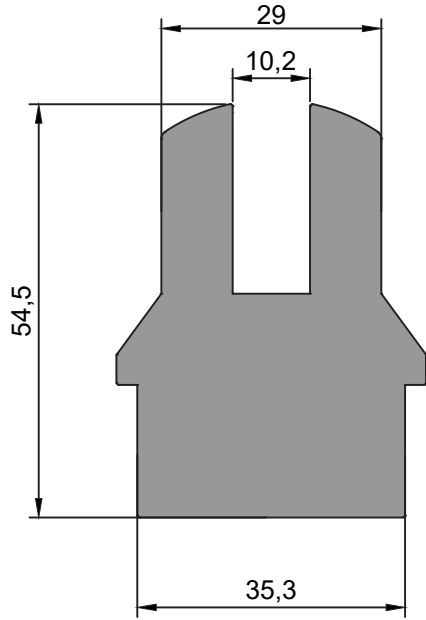

1190
Küpeşte Profili
4,065 kg/m

KÜPEŞTE PROFİLLERİ

HANDRAILS PROFILES

★ Yandaki profil birim ağırlıkları, bilgisayarda hesaplanmış teorik ağırlıklardır.

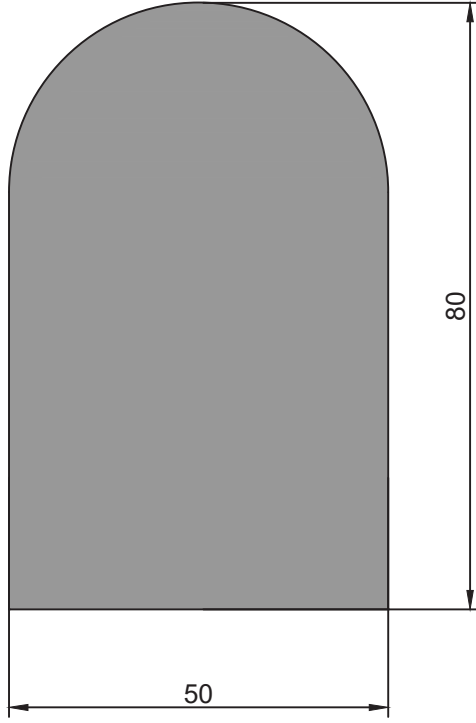

1065
Küpeşte Profili
10,11 kg/m

KÜPEŞTE PROFİLLERİ

HANDRAILS PROFILES

★ Yandaki profil birim ağırlıkları, bilgisayarda hesaplanmış teorik ağırlıklardır.

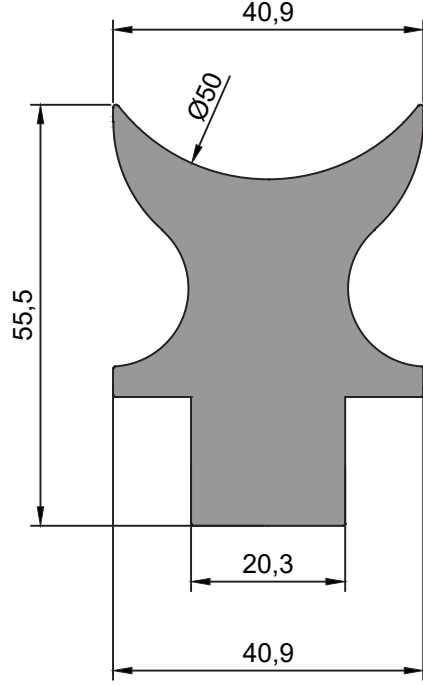

1189
Küpeşte Profili
3,506 kg/m

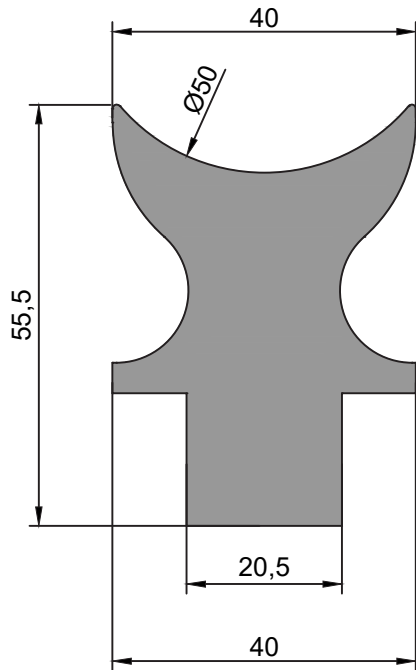

1025
Küpeşte Profili
3,516 kg/m

KÜPEŞTE PROFİLLERİ

HANDRAILS PROFILES

★ Yandaki profil birim ağırlıkları, bilgisayarda hesaplanmış teorik ağırlıklardır.

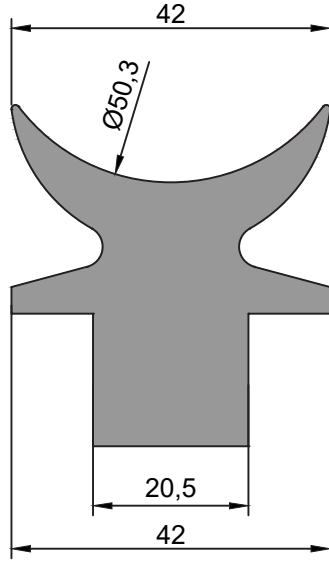

1026
Küpeşte Profili
2,636 kg/m

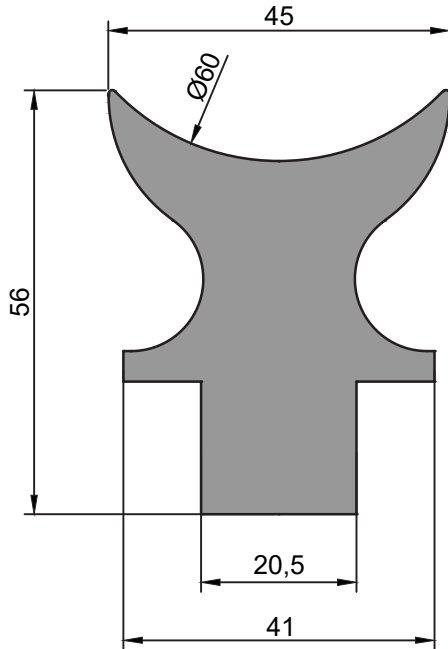

1732
Küpeşte Profili
3,609 kg/m

KÜPEŞTE PROFİLLERİ

HANDRAILS PROFILES

★ Yandaki profil birim ağırlıkları, bilgisayarla hesaplanmış teorik ağırlıklardır.

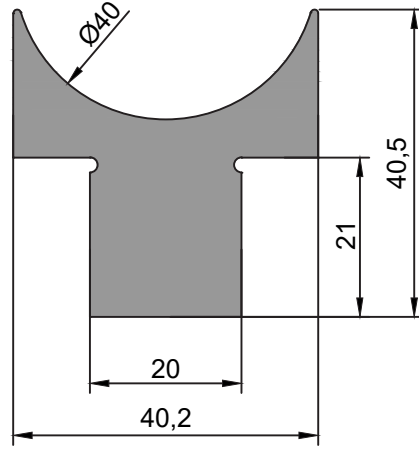

1038
Küpeşte Profili
2,140 kg/m

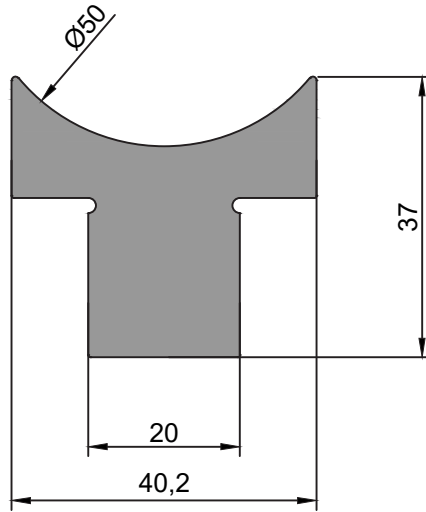

1039
Küpeşte Profili
2,201 kg/m

PROFİL KATALOĞU

KARE KÜPEŞTE PROFİLLERİ

SQUARE PROFILES











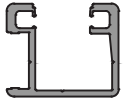
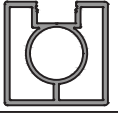

* Profil Ağırlıkları Teorik Olup Teslim Anındaki Ağırlık Geçerlidir

* *Weight of profiles are theoretical, net weight will valid at the time of delivery.*

KARE KÜPEŞTE PROFİLLERİ

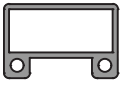







SQUARE PROFILES

★ Yandaki profil birim ağırlıkları, bilgisayarda hesaplanmış teorik ağırlıklardır.

PROFİL KESİTİ	PROFİL KODU	PROFİL ADI	AĞIRLIK	ATALET MOMENTLERİ		SAYFA NO
				J_x (cm ⁴)	J_y (cm ⁴)	
	2877	80'lik Üst Profil	1,300 kg/m	
	2808	60'lık Üst Profil	0,856 kg/m	
	2878	Alt Profil	0,485 kg/m	
	2879	40'lık Dikme Profili	1,165 kg/m	
	2893	Dikme Kapak	0,055 kg/m	
	2880	Alt Profil Kapak	0,058 kg/m	
	3531	14'lük Emniyet Çubuğu	0,260 kg/m	
	4040	Küpeşte Profili	0,921 kg/m	
	4041	Küpeşte Profili	1,951 kg/m	
	4042	Küpeşte Profili	2,196 kg/m	
	4043	Küpeşte Profili	1,680 kg/m	
	4044	Küpeşte Profili	0,058 kg/m	
	4045	Küpeşte Profili	0,586 kg/m	
	4046	Küpeşte Profili	4,427 kg/m	

KARE KÜPEŞTE PROFİLLERİ

SQUARE PROFILES

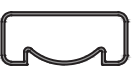
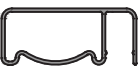
PROFİL KESİTİ	PROFİL KODU	PROFİL ADI	AĞIRLIK	ATALET MOMENTLERİ		SAYFA NO
				J_x (cm ⁴)	J_y (cm ⁴)	
	4361	Küpeşte Profili	0,077 kg/m	
	4362	Küpeşte Profili	0,363 kg/m	
	4363	Küpeşte Profili	0,087 kg/m	
	4364	Küpeşte Profili	0,114 kg/m	
	4365	Küpeşte Profili	0,179 kg/m	
	4366	Küpeşte Profili	0,683 kg/m	
	4367	Küpeşte Profili	0,081 kg/m	
	4368	Küpeşte Profili	0,824 kg/m	
	4369	Küpeşte Profili	0,076 kg/m	
	4370	Küpeşte Profili	0,704 kg/m	
	4371	Küpeşte Profili	0,718 kg/m	
				
				
				

★ Yandaki profil birim ağırlıkları, bilgisayarda hesaplanmış teorik ağırlıklardır.

KARE KÜPEŞTE PROFİLLERİ

SQUARE PROFILES

★ Yandaki profil birim ağırlıkları, bilgisayarla hesaplanmış teorik ağırlıklardır.

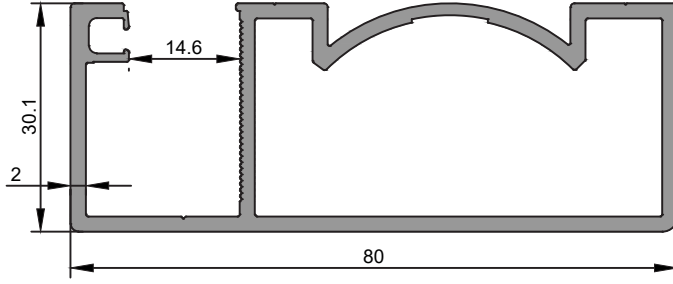

2877
80'lik Üst Profil
1,300 kg/m

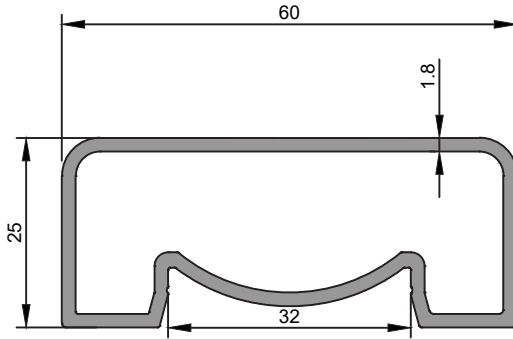

2808
60'lik Üst Profil
0,856 kg/m

KARE KÜPEŞTE PROFİLLERİ

SQUARE PROFILES

★ Yandaki profil birim ağırlıkları, bilgisayarda hesaplanmış teorik ağırlıklardır.

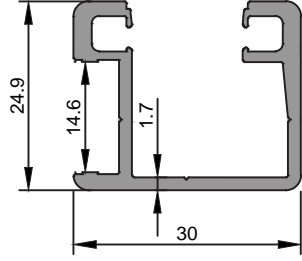

2878

Alt Profil

0,485 kg/m

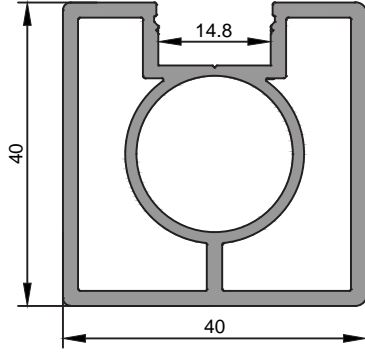

2879

40'lık Dikme Profili

1,165 kg/m

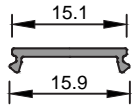

2893

Dikme Kapak

0,055 kg/m

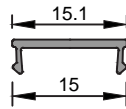

2880

Alt Profil Kapak

0,058 kg/m

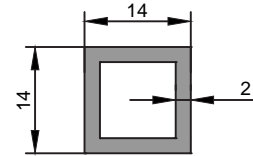

3531

14'lük Emniyet Çubuğu

0,260 kg/m

KARE KÜPEŞTE PROFİLLERİ

SQUARE PROFILES

★ Yandaki profil birim ağırlıkları, bilgisayarla hesaplanmış teorik ağırlıklardır.

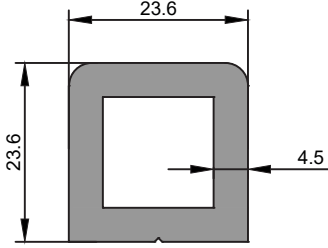

4040
Küpeşte Profil
0,921 kg/m

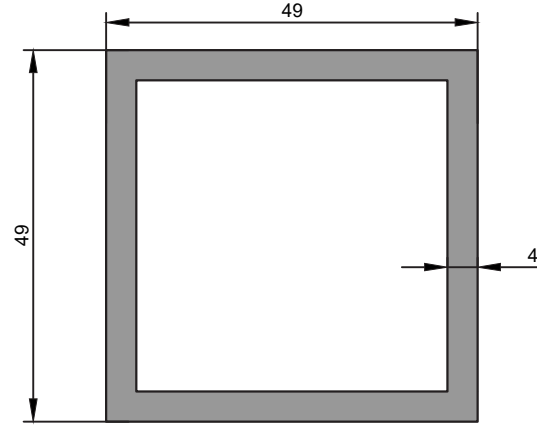

4041
Küpeşte Profil
1,951 kg/m

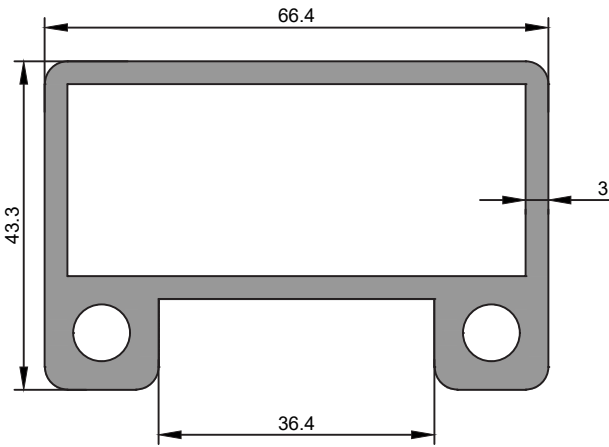

4042
Küpeşte Profil
2,196 kg/m

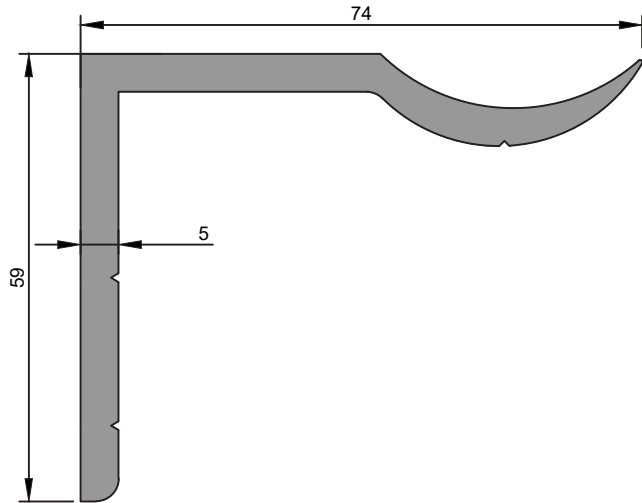

4043
Küpeşte Profil
1,680 kg/m

KARE KÜPEŞTE PROFİLLERİ

SQUARE PROFILES

★ Yandaki profil birim ağırlıkları, bilgisayarda hesaplanmış teorik ağırlıklardır.

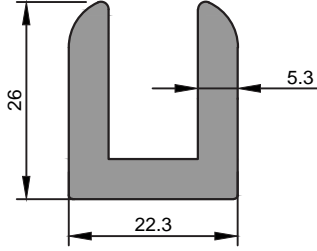

4044

Alt Profil Kapak

0,058 kg/m

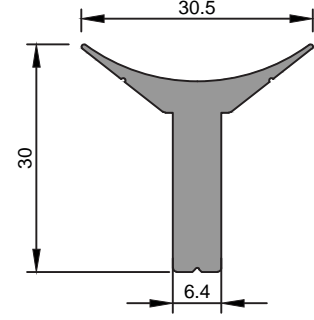

4045

Küpeşte Profil

0,586 kg/m

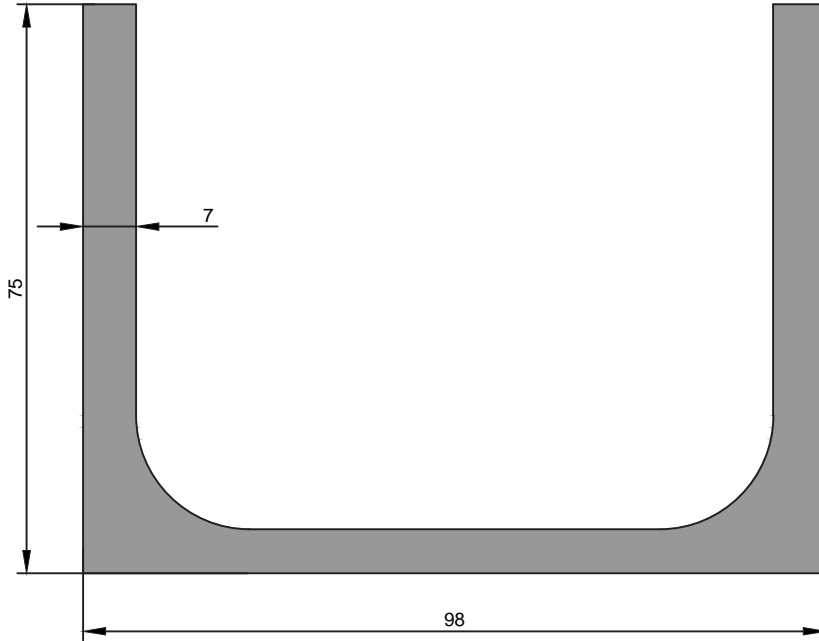

4046

Küpeşte Profil

4,427 kg/m

KARE KÜPEŞTE PROFİLLERİ

SQUARE PROFILES

★ Yandaki profil birim ağırlıkları, bilgisayarda hesaplanmış teorik ağırlıklardır.

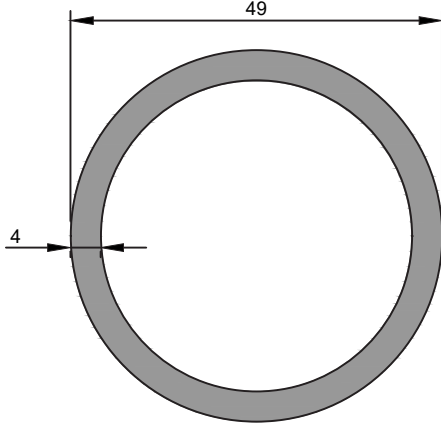

4047
Küpeşte Profil
1,533 kg/m

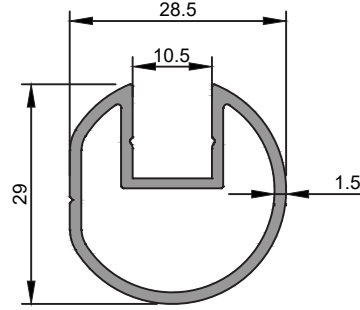

4360
Küpeşte Profil
0,450 kg/m

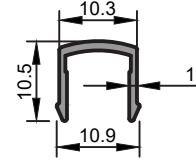

4361
Küpeşte Profil
0,077 kg/m

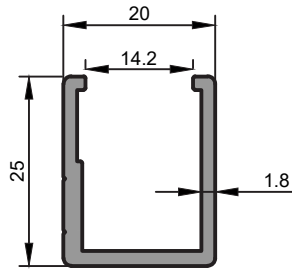

4362
Küpeşte Profil
0,363 kg/m

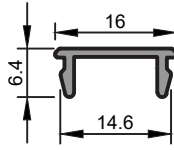

4363
Küpeşte Profil
0,087 kg/m

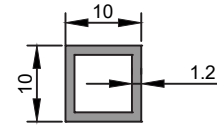

4364
Küpeşte Profil
0,114 kg/m

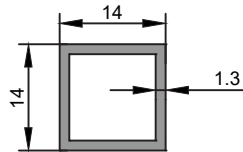

4365
Küpeşte Profil
0,179 kg/m

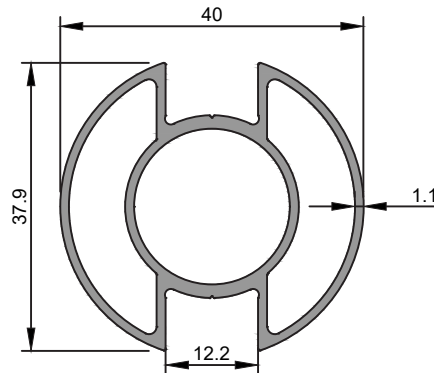

4366
Küpeşte Profil
0,683 kg/m

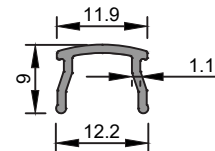

4367
Küpeşte Profil
0,081 kg/m

KARE KÜPEŞTE PROFİLLERİ

SQUARE PROFILES

★ Yandaki profil birim ağırlıkları, bilgisayararda hesaplanmış teorik ağırlıklardır.

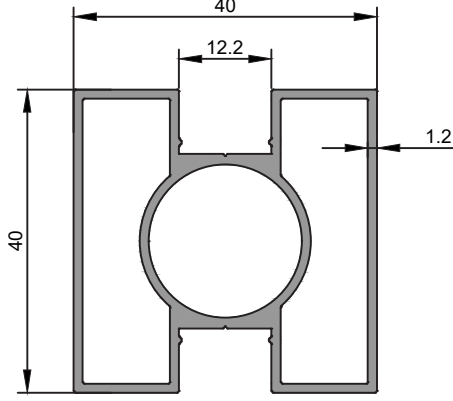

4368
Küpeşte Profil
0,824 kg/m

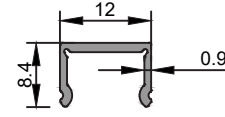

4369
Küpeşte Profil
0,076 kg/m

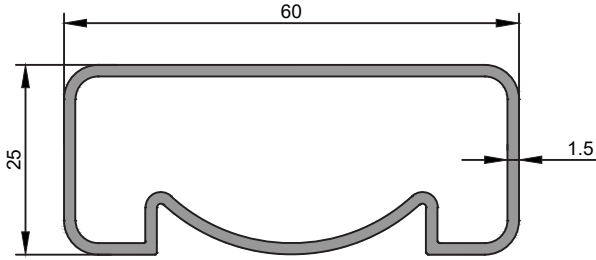

4370
Küpeşte Profil
0,704 kg/m

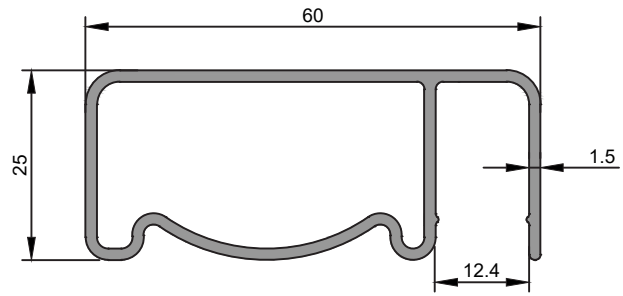

4371
Küpeşte Profil
0,718 kg/m

PROFİL KATALOĞU

CAM KÜPEŞTE PROFİLLERİ

GLASS HANDRAILS PROFILES









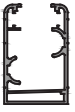

* Profil Ağırlıkları Teorik Olup Teslim Anındaki Ağırlık Geçerlidir

* *Weight of profiles are theoretical, net weight will valid at the time of delivery.*

CAM KÜPEŞTE PROFİLLERİ

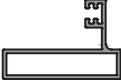
GLASS HANDRAILS PROFILES

★ Yandaki profil birim ağırlıkları, bilgisayarda hesaplanmış teorik ağırlıklardır.

PROFİL KESİTİ	PROFİL KODU	PROFİL ADI	AĞIRLIK	ATALET MOMENTLERİ		SAYFA NO
				J_x (cm ⁴)	J_y (cm ⁴)	
	3973	Küpeşte Profili	3,261 kg/m	
	3097	Küpeşte Profili	1,302 kg/m	
	2572	Küpeşte Profili	0,135 kg/m	
	2573	Küpeşte Profili	0,214 kg/m	
	3095	Küpeşte Profili	0,423 kg/m	
	3096	Küpeşte Profili	0,877 kg/m	
	2769	Küpeşte Profili	0,442 kg/m	
	2575	Küpeşte Profili	0,460 kg/m	
	2576	Küpeşte Profili	0,921 kg/m	
	2771	Küpeşte Profili	0,805 kg/m	
	2574	Küpeşte Profili	1,490 kg/m	
	2770	Küpeşte Profili	1,507 kg/m	

CAM KÜPEŞTE PROFİLLERİ

GLASS HANDRAILS PROFILES

★ Yandaki profil birim ağırlıkları, bilgisayararda hesaplanmış teorik ağırlıklardır.

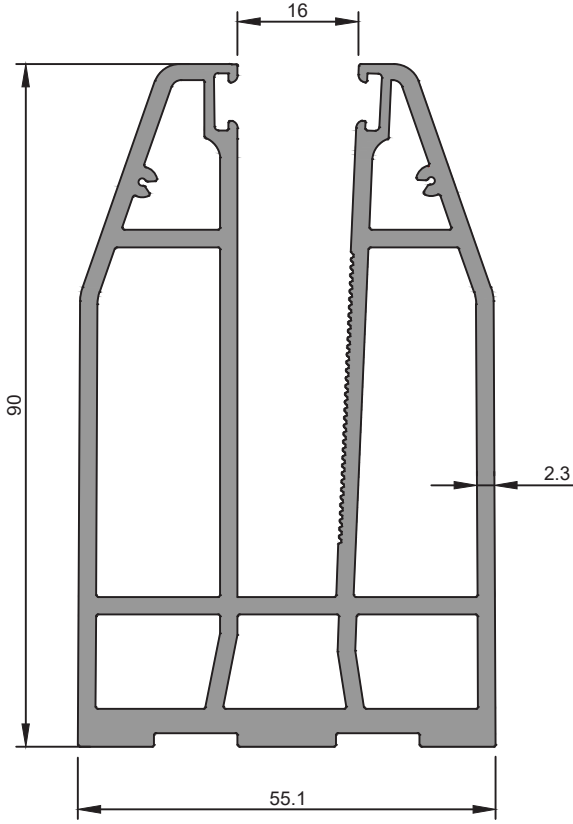

3973
Küpeşte Profil
3,261 kg/m

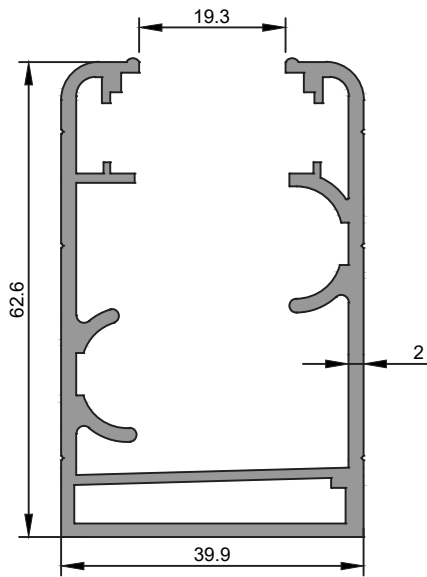

3097
Küpeşte Profil
1,302 kg/m

CAM KÜPEŞTE PROFİLLERİ

GLASS HANDRAILS PROFILES

★ Yandaki profil birim ağırlıkları, bilgisayarla hesaplanmış teorik ağırlıklardır.

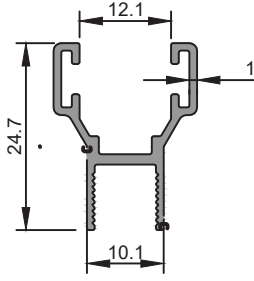

2573
Küpeşte Profil
0,214 kg/m

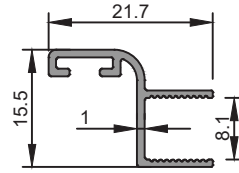

2572
Küpeşte Profil
0,135 kg/m

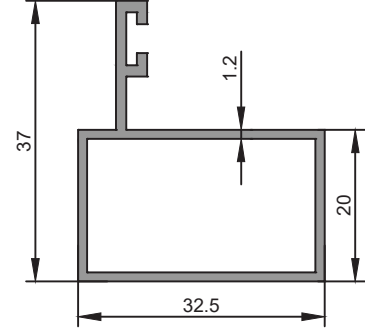

3095
Küpeşte Profil
0,423 kg/m

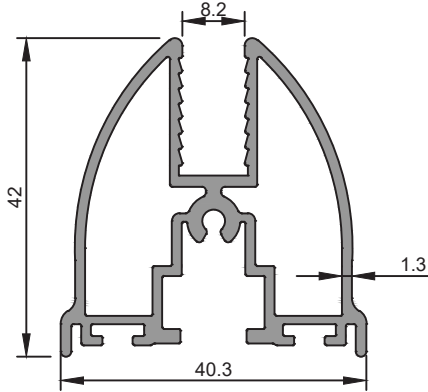

3096
Küpeşte Profil
0,877 kg/m

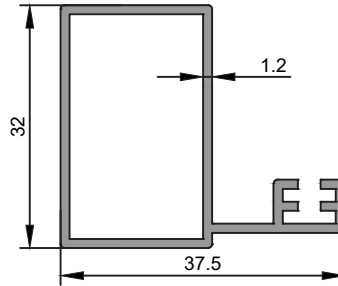

2769
Küpeşte Profil
0,442 kg/m

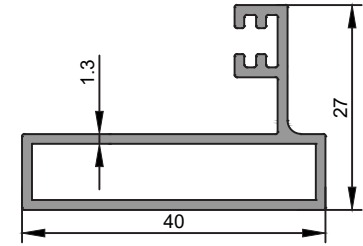

2575
Küpeşte Profil
0,460 kg/m

CAM KÜPEŞTE PROFİLLERİ

GLASS HANDRAILS PROFILES

★ Yandaki profil birim ağırlıkları, bilgisayarda hesaplanmış teorik ağırlıklardır.

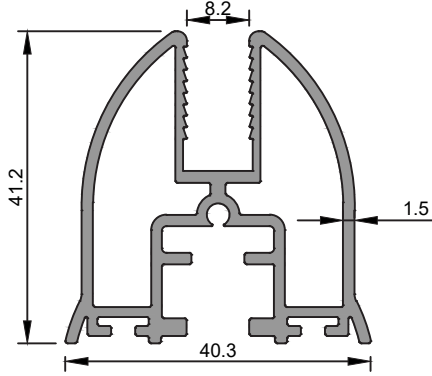

2576
Küpeşte Profil
0,921 kg/m

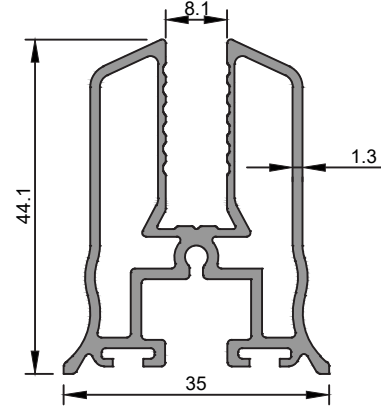

2771
Küpeşte Profil
0,805 kg/m

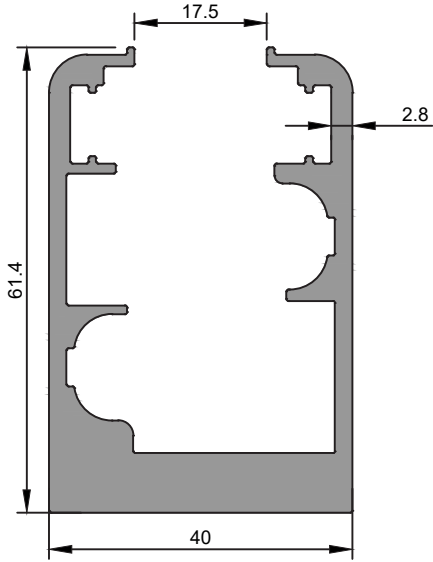

2574
Küpeşte Profil
1,490 kg/m

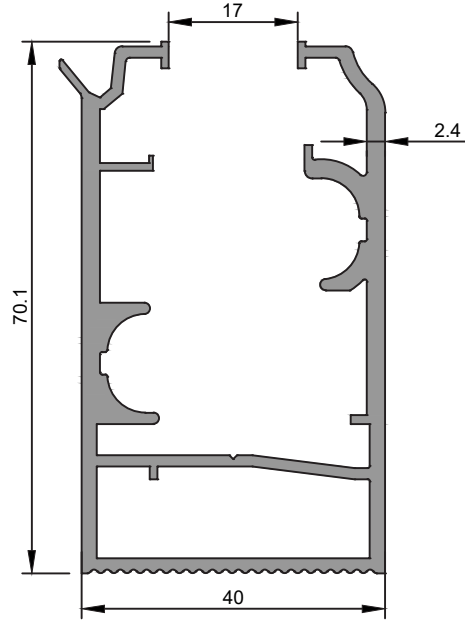

2770
Küpeşte Profil
1,507 kg/m

PROFİL KATALOĞU

MOBİLYA PROFİLLERİ

FURNITURE PROFILES















★ Profil Ağırlıkları Teorik Olup Teslim Anındaki Ağırlık Geçerlidir

★ *Weight of profiles are theoretical, net weight will valid at the time of delivery.*

MOBİLYA PROFİLLERİ

FURNITURE PROFILES









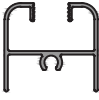

★ Yandaki profil birim ağırlıkları, bilgisayarda hesaplanmış teorik ağırlıklardır.

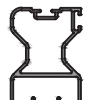
PROFİL KESİTİ	PROFİL KODU	PROFİL ADI	AĞIRLIK	ATALET MOMENTLERİ		SAYFA NO
				J_x (cm ⁴)	J_y (cm ⁴)	
	1960	...	0,261 kg/m	
	1961	...	0,396 kg/m	
	1962	...	0,242 kg/m	
	1116	...	0,244 kg/m	
	1631	...	0,589 kg/m	
	1996	...	0,265 kg/m	
	2007	...	0,262 kg/m	
	1975	...	0,487 kg/m	
	2024	...	0,474 kg/m	
	1664	...	0,260 kg/m	
	1596	...	0,347 kg/m	
	1641	...	0,331 kg/m	
	1965	...	0,362 kg/m	
	1598	...	0,305 kg/m	

MOBİLYA PROFİLLERİ

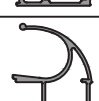
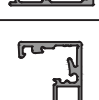
FURNITURE PROFILES

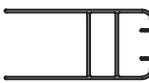
★ Yandaki profil birim ağırlıkları, bilgisayarda hesaplanmış teorik ağırlıklardır.

PROFİL KESİTİ	PROFİL KODU	PROFİL ADI	AĞIRLIK	ATALET MOMENTLERİ		SAYFA NO
				J_x (cm ⁴)	J_y (cm ⁴)	
	1956	...	0,356 kg/m	
	2045	...	0,221 kg/m	
	2046	...	0,276 kg/m	
	2050	...	0,358 kg/m	
	2048	...	0,442 kg/m	
	1665	...	0,495 kg/m	
	1813	...	0,466 kg/m	
	1581	...	0,392 kg/m	
	1148	...	0,389 kg/m	
	1180	...	0,283 kg/m	
	2049	...	0,222 kg/m	
	2045	...	0,519 kg/m	
	2047	...	0,385 kg/m	
	1249	...	0,733 kg/m	

MOBİLYA PROFİLLERİ

FURNITURE PROFILES













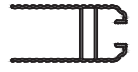

★ Yandaki profil birim ağırlıkları, bilgisayarda hesaplanmış teorik ağırlıklardır.

PROFİL KESİTİ	PROFİL KODU	PROFİL ADI	AĞIRLIK	ATALET MOMENTLERİ		SAYFA NO
				J_x (cm ⁴)	J_y (cm ⁴)	
	1245	...	0,695 kg/m	
	1179	...	0,661 kg/m	
	1242	...	0,571 kg/m	
	1309	...	0,326 kg/m	
	1385	...	0,326 kg/m	
	1498	...	0,322 kg/m	
	1181	...	0,391 kg/m	
	1182	...	0,485 kg/m	
	1186	...	0,64 kg/m	
	1467	...	0,495 kg/m	
	1698	...	0,459 kg/m	
	1548	...	0,256 kg/m	
	1549	...	0,320 kg/m	
	1669	...	0,292 kg/m	

MOBİLYA PROFİLLERİ

FURNITURE PROFILES

★ Yandaki profil birim ağırlıkları, bilgisayarda hesaplanmış teorik ağırlıklardır.

PROFİL KESİTİ	PROFİL KODU	PROFİL ADI	AĞIRLIK	ATALET MOMENTLERİ		SAYFA NO
				J_x (cm ⁴)	J_y (cm ⁴)	
	1670	...	0,340 kg/m	
	1276	...	0,346 kg/m	
	1278	...	0,497 kg/m	
	1668	...	0,528 kg/m	
	1550	...	0,425 kg/m	
	1551	...	0,508 kg/m	
	1620	...	0,209 kg/m	
	1663	...	0,60 kg/m	
	1666	...	0,434 kg/m	
	1546	...	0,445 kg/m	
	1547	...	0,236 kg/m	
	1279	...	0,603 kg/m	
	1277	...	0,228 kg/m	
	1671	...	0,376 kg/m	

MOBİLYA PROFİLLERİ

FURNITURE PROFILES















★ Yandaki profil birim ağırlıkları, bilgisayarda hesaplanmış teorik ağırlıklardır.

PROFİL KESİTİ	PROFİL KODU	PROFİL ADI	AĞIRLIK	ATALET MOMENTLERİ		SAYFA NO
				J_x (cm ⁴)	J_y (cm ⁴)	
	1392	...	0,263 kg/m	
	1393	...	0,276 kg/m	
	1360	...	0,146 kg/m	
	2035	...	0,379 kg/m	
	1661	...	0,239 kg/m	
	1662	...	0,167 kg/m	
	2033	...	0,156 kg/m	
	1816	...	0,135 kg/m	
	1963	...	0,147 kg/m	
	1964	...	0,224 kg/m	
	2043	...	0,299 kg/m	
	1141	...	0,208 kg/m	
	1815	...	0,167 kg/m	
	2031	...	0,309 kg/m	

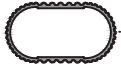
MOBİLYA PROFİLLERİ

FURNITURE PROFILES

★ Yandaki profil birim ağırlıkları, bilgisayarda hesaplanmış teorik ağırlıklardır.

PROFİL KESİTİ	PROFİL KODU	PROFİL ADI	AĞIRLIK	ATALET MOMENTLERİ		SAYFA NO
				J_x (cm ⁴)	J_y (cm ⁴)	
	1824	...	0,219 kg/m	
	1968	...	0,101 kg/m	
	1974	...	0,79 kg/m	
	2085	...	0,92 kg/m	
	1766	...	0,69 kg/m	
	1049	...	0,63 kg/m	
	1376	...	0,234 kg/m	
	1377	...	0,218 kg/m	
	1957	...	0,197 kg/m	
	1449	...	0,190 kg/m	
	1291	...	0,311 kg/m	
	1814	...	0356 kg/m	
	2034	...	0,163 kg/m	
	1966	...	0,215 kg/m	

MOBİLYA PROFİLLERİ

FURNITURE PROFILES

★ Yandaki profil birim ağırlıkları, bilgisayarda hesaplanmış teorik ağırlıklardır.

PROFİL KESİTİ	PROFİL KODU	PROFİL ADI	AĞIRLIK	ATALET MOMENTLERİ		SAYFA NO
				J_x (cm ⁴)	J_y (cm ⁴)	
	1967	...	0,192 kg/m	
	1667	...	0,312 kg/m	
	1715	...	0,106 kg/m	
	1954	...	0,288 kg/m	
	1689	...	0,222 kg/m	
	1716	...	0,170 kg/m	
	1859	...	0,282 kg/m	
	1608	...	0,538 kg/m	
	1684	...	0,822 kg/m	
	2032	...	0,530 kg/m	
	1741	...	0,294 kg/m	
	1742	...	0,360 kg/m	
	1530	...	0,549 kg/m	
	1638	...	0,676 kg/m	

MOBİLYA PROFİLLERİ

FURNITURE PROFILES











★ Yandaki profil birim ağırlıkları, bilgisayarda hesaplanmış teorik ağırlıklardır.

PROFİL KESİTİ	PROFİL KODU	PROFİL ADI	AĞIRLIK	ATALET MOMENTLERİ		SAYFA NO
				J_x (cm ⁴)	J_y (cm ⁴)	
	1736	...	0,488 kg/m	
	1688	...	0,187 kg/m	
	1708	...	0,119 kg/m	
	1710	...	0,112 kg/m	
	1814	...	0,491 kg/m	
	1712	...	0,141 kg/m	
	1709	...	0,68 kg/m	
	1711	...	0,71 kg/m	
	1714	...	0,346 kg/m	
	1460	...	0,279 kg/m	
	1428	...	0,249 kg/m	
	1687	...	0,479 kg/m	
	1293	...	0,683 kg/m	
	1597	...	0,396 kg/m	

MOBİLYA PROFİLLERİ

FURNITURE PROFILES

★ Yandaki profil birim ağırlıkları, bilgisayarda hesaplanmış teorik ağırlıklardır.

PROFİL KESİTİ	PROFİL KODU	PROFİL ADI	AĞIRLIK	ATALET MOMENTLERİ		SAYFA NO
				J_x (cm ⁴)	J_y (cm ⁴)	
	1743	...	0,506 kg/m	
	1713	...	0,259 kg/m	
	1898	...	0,291 kg/m	
	1899	...	0,463 kg/m	
	1900	...	0,434 kg/m	
	1901	...	0,394 kg/m	
	1306	...	0,351 kg/m	
	1307	...	0,310 kg/m	
	1727	...	0,312 kg/m	
	1427	...	0,430 kg/m	

MOBİLYA PROFİLLERİ

FURNITURE PROFILES

★ Yandaki profil birim ağırlıkları, bilgisayarda hesaplanmış teorik ağırlıklardır.

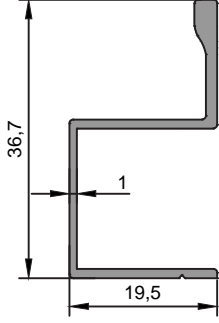

1960

0,261 kg/m

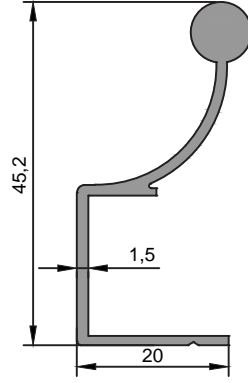

1961

0,396 kg/m

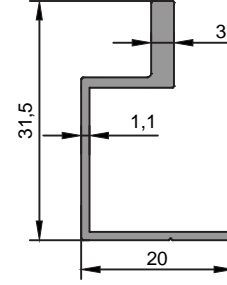

1962

0,242 kg/m

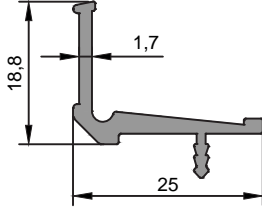

1116

0,244 kg/m

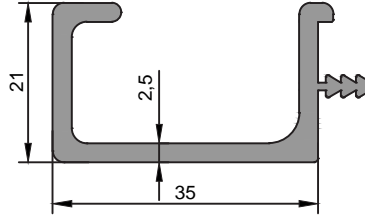

1631

0,589 kg/m

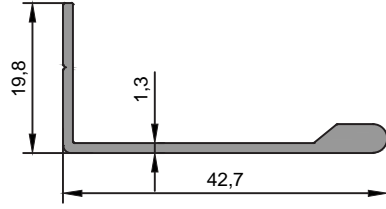

1996

0,265 kg/m

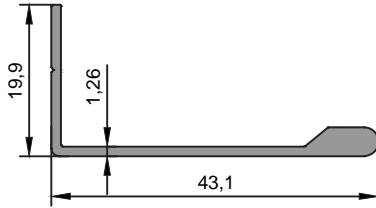

2007

0,262 kg/m

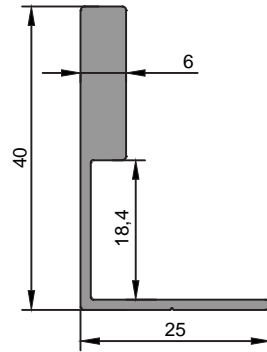

1975

0,487 kg/m

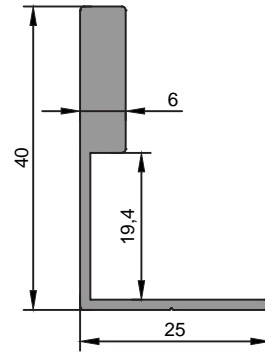

2024

0,474 kg/m

MOBİLYA PROFİLLERİ

FURNITURE PROFILES

★ Yandaki profil birim ağırlıkları, bilgisayarda hesaplanmış teorik ağırlıklardır.

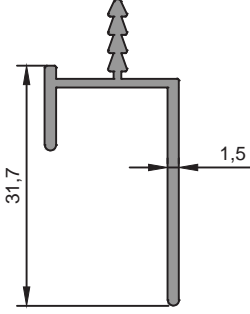

1664

0,260 kg/m

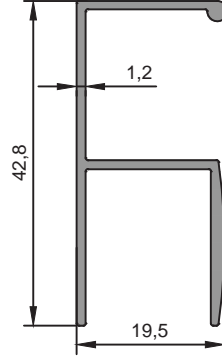

1596

0,347 kg/m

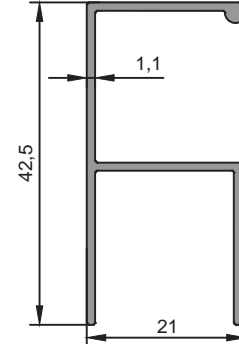

1641

0,331 kg/m

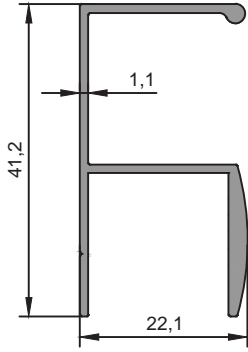

1965

0,362 kg/m

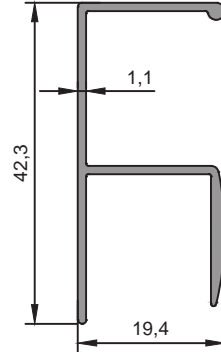

1598

0,305 kg/m

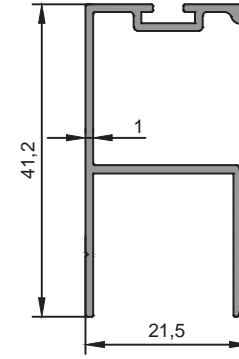

1956

0,336 kg/m

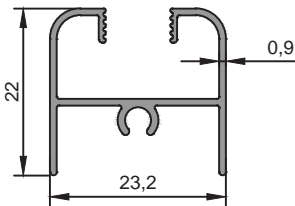

2045

0,221 kg/m

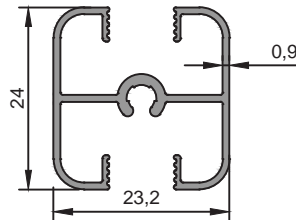

2046

0,276 kg/m

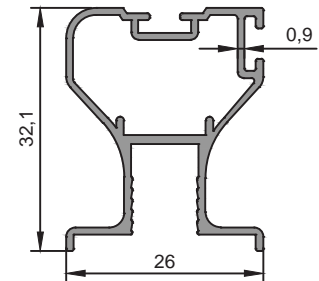

2050

0,358 kg/m

MOBİLYA PROFİLLERİ

FURNITURE PROFILES

★ Yandaki profil birim ağırlıkları, bilgisayar yardımıyla hesaplanmış teorik ağırlıklardır.

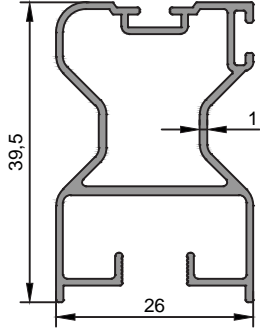

2048

0,442 kg/m

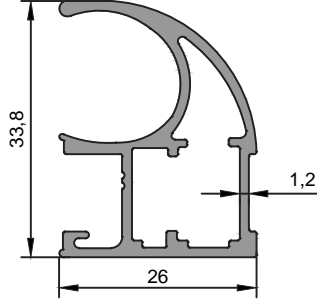

1665

0,495 kg/m

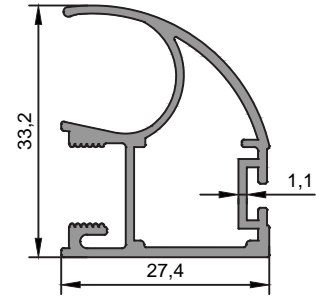

1813

0,466 kg/m

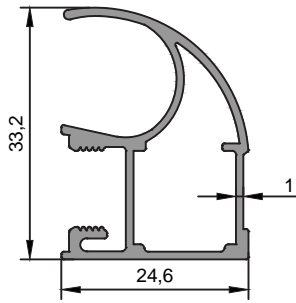

1581

0,392 kg/m

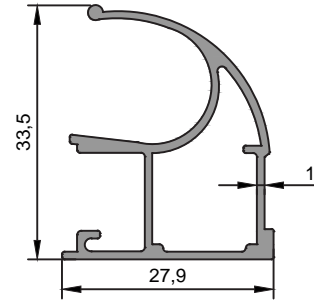

1148

0,389 kg/m

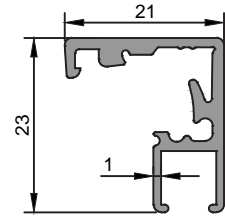

1180

0,283 kg/m

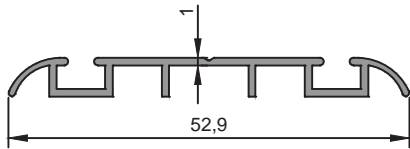

2049

0,222 kg/m

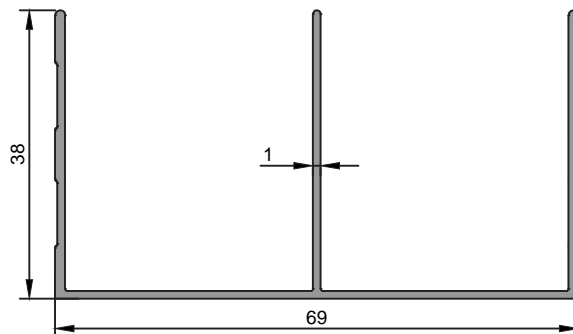

2044

0,519 kg/m

MOBİLYA PROFİLLERİ

FURNITURE PROFILES

★ Yandaki profil birim ağırlıkları, bilgisayarda hesaplanmış teorik ağırlıklardır.

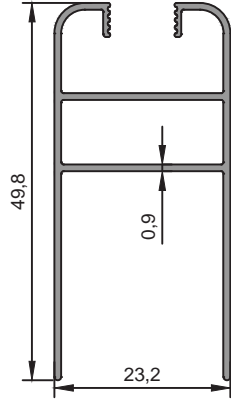

2047
0,385 kg/m

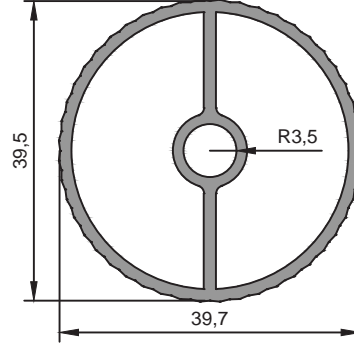

1249
0,733 kg/m

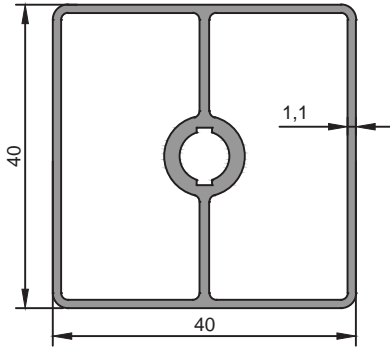

1245
0,695 kg/m

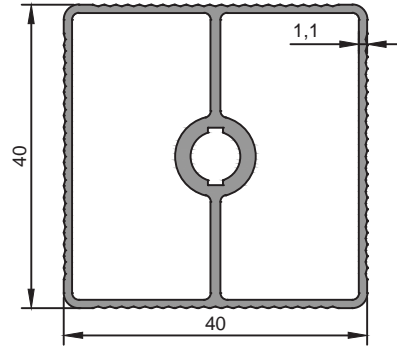

1179
0,661 kg/m

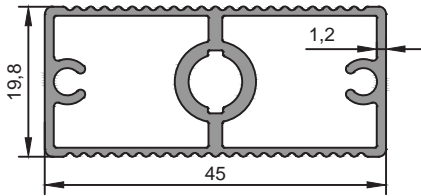

1242
0,571 kg/m

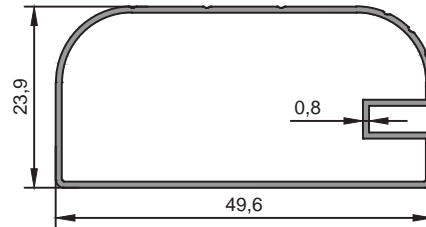

1309
0,326 kg/m

MOBİLYA PROFİLLERİ

FURNITURE PROFILES

★ Yandaki profil birim ağırlıkları, bilgisayarda hesaplanmış teorik ağırlıklardır.

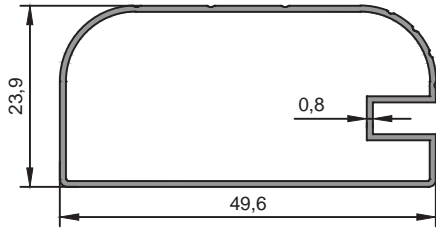

1385

0,326 kg/m

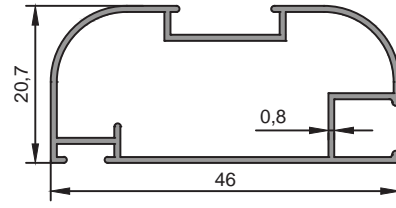

1498

0,322 kg/m

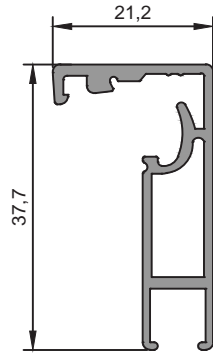

1181

0,391 kg/m

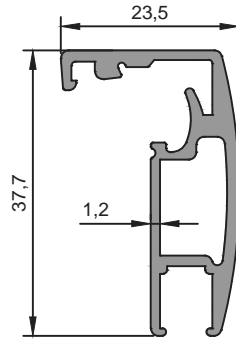

1182

0,485 kg/m

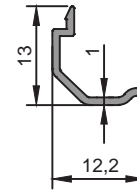

1186

0,64 kg/m

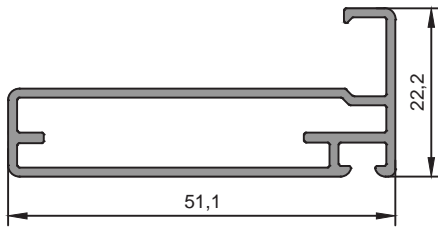

1467

0,495 kg/m

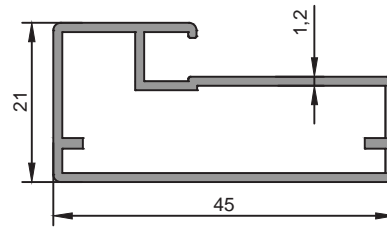

1698

0,459 kg/m

MOBİLYA PROFİLLERİ

FURNITURE PROFILES

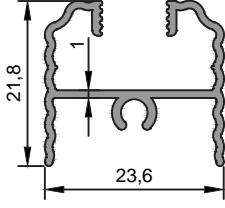

1548

0,256 kg/m

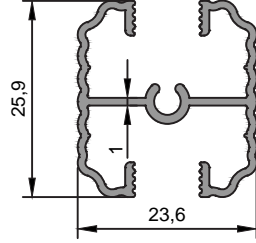

1549

0,320 kg/m

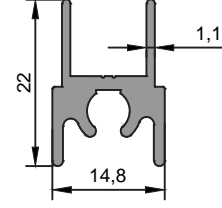

1669

0,292 kg/m

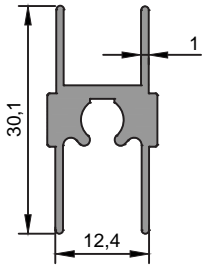

1670

0,340 kg/m

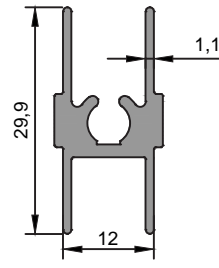

1276

0,346 kg/m

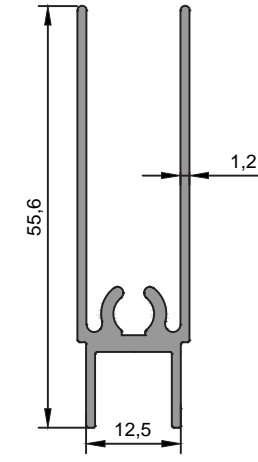

1278

0,497 kg/m

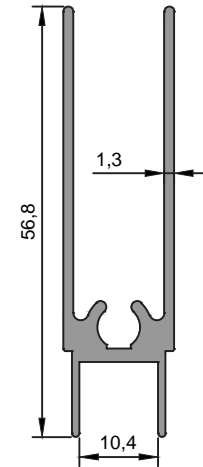

1668

0,528 kg/m

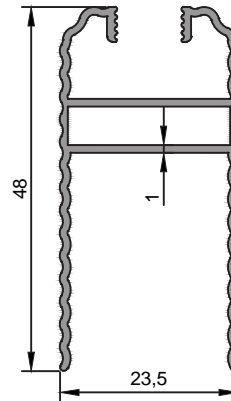

1550

0,425 kg/m

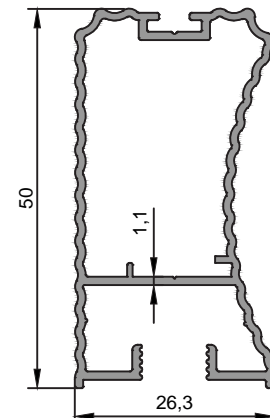

1551

0,508 kg/m

★ Yandaki profil birim ağırlıkları, bilgisayarda hesaplanmış teorik ağırlıklardır.

MOBİLYA PROFİLLERİ

FURNITURE PROFILES

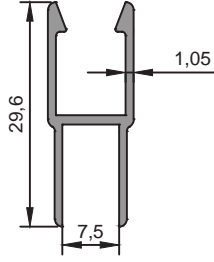

1620
0,209 kg/m

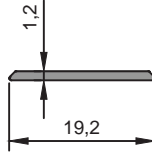

1663
0,60 kg/m

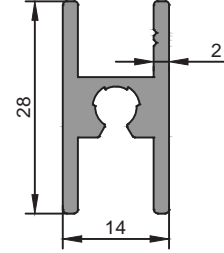

1666
0,434 kg/m

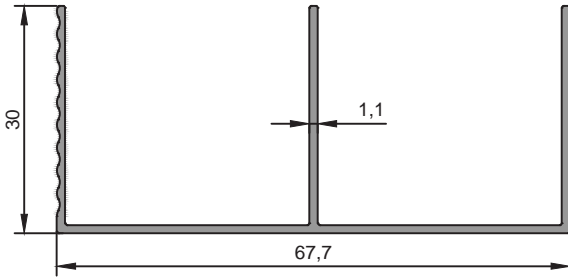

1546
0,445 kg/m

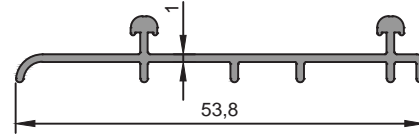

1547
0,236 kg/m

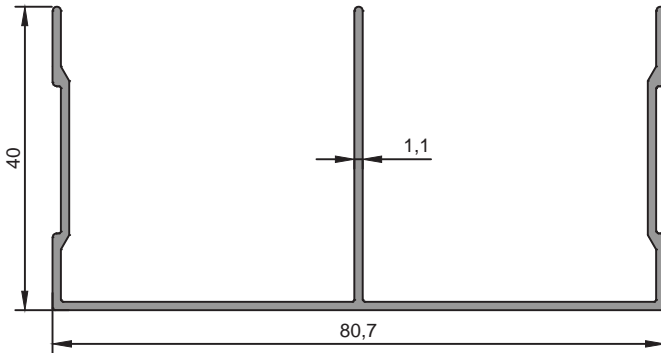

1279
0,603 kg/m

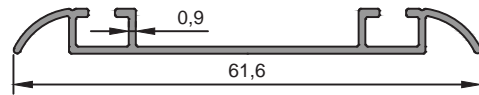

1277
0,228 kg/m

★ Yandaki profil birim ağırlıkları, bilgisayarda hesaplanmış teorik ağırlıklardır.

MOBİLYA PROFİLLERİ

FURNITURE PROFILES

★ Yandaki profil birim ağırlıkları, bilgisayarda hesaplanmış teorik ağırlıklardır.

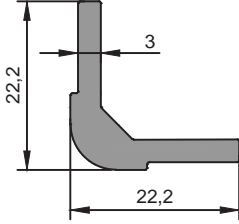

1671

0,376 kg/m

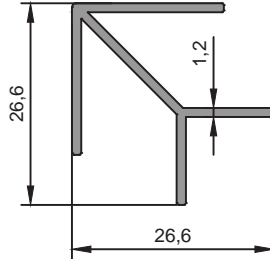

1392

0,263 kg/m

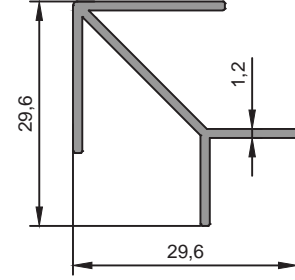

1393

0,276 kg/m

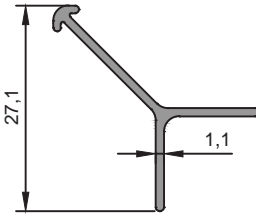

1360

0,146 kg/m

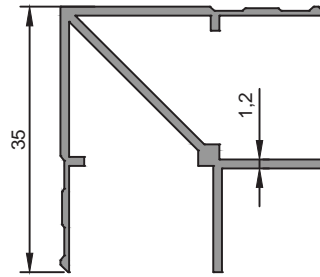

2035

0,379 kg/m

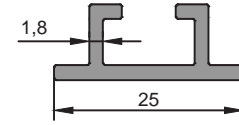

1661

0,239 kg/m

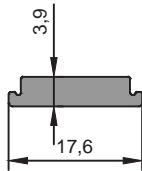

1662

0,167 kg/m

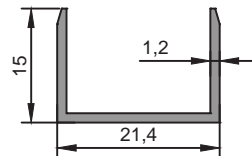

2033

0,156 kg/m

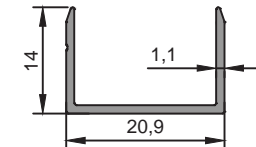

1816

0,135 kg/m

MOBİLYA PROFİLLERİ

FURNITURE PROFILES

★ Yandaki profil birim ağırlıkları, bilgisayararda hesaplanmış teorik ağırlıklardır.

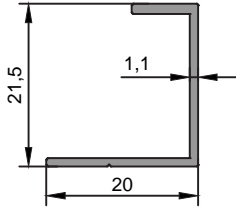

1963

0,147 kg/m

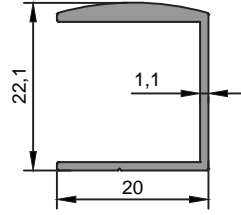

1964

0,224 kg/m

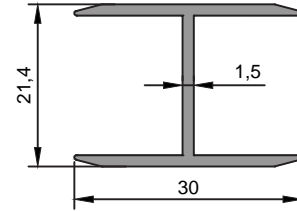

2043

0,299 kg/m

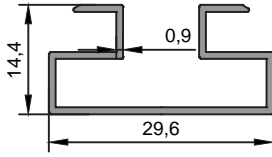

1141

0,208 kg/m

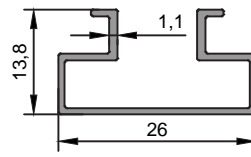

1815

0,167 kg/m

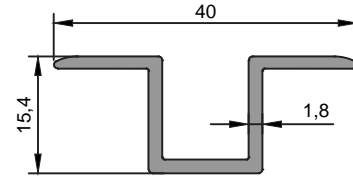

2031

0,309 kg/m

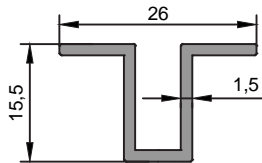

1824

0,219 kg/m

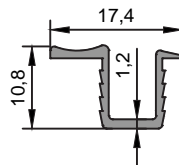

1968

0,101 kg/m

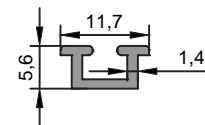

1974

0,79 kg/m

MOBİLYA PROFİLLERİ

FURNITURE PROFILES

★ Yandaki profil birim ağırlıkları, bilgisayararda hesaplanmış teorik ağırlıklardır.

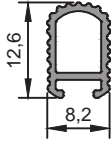

2085
0,92 kg/m

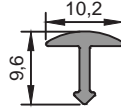

1766
0,69 kg/m

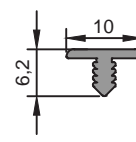

1049
0,63 kg/m

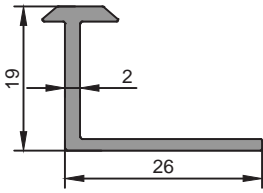

1376
0,234 kg/m

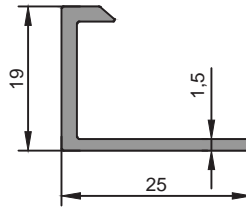

1377
0,218 kg/m

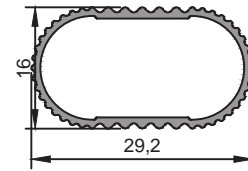

1957
0,197 kg/m

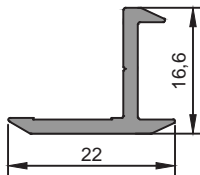

1449
0,190 kg/m

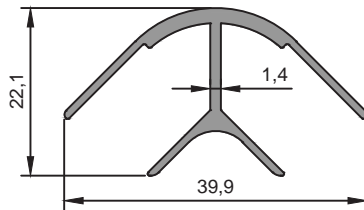

1291
0,311 kg/m

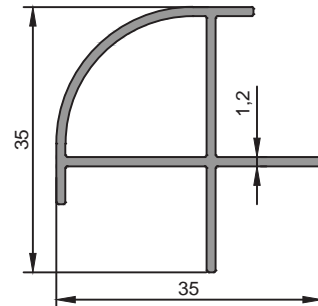

1814
0,356 kg/m

MOBİLYA PROFİLLERİ

FURNITURE PROFILES

★ Yandaki profil birim ağırlıkları, bilgisayarda hesaplanmış teorik ağırlıklardır.

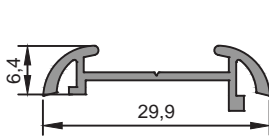

2034

0,163 kg/m

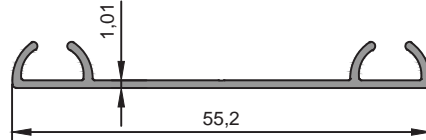

1966

0,215 kg/m

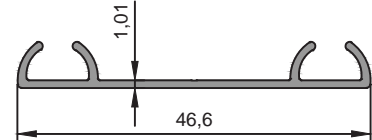

1967

0,192 kg/m

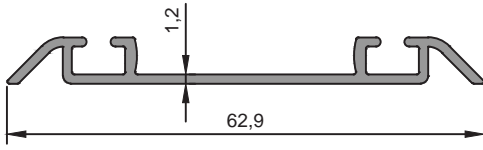

1667

0,312 kg/m

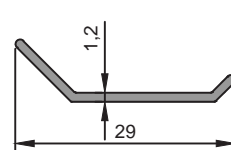

1715

0,106 kg/m

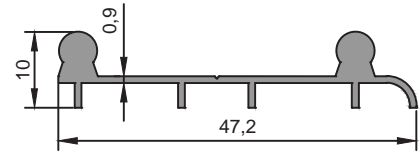

1954

0,288 kg/m

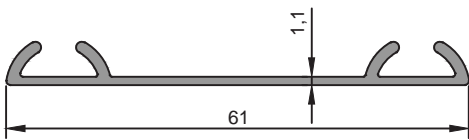

1689

0,222 kg/m

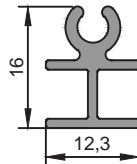

1716

0,170 kg/m

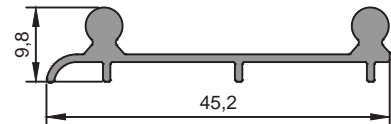

1859

0,282 kg/m

★ Yandaki profil birim ağırlıkları, bilgisayarda hesaplanmış teorik ağırlıklardır.

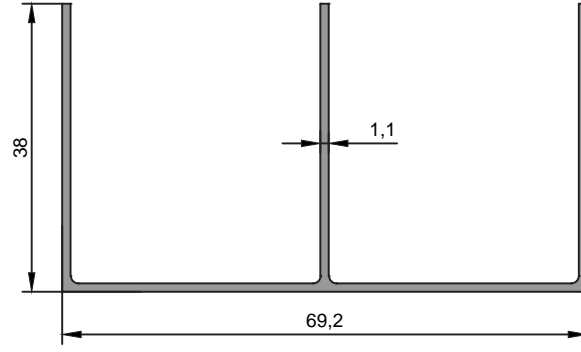

1608
0,538 kg/m

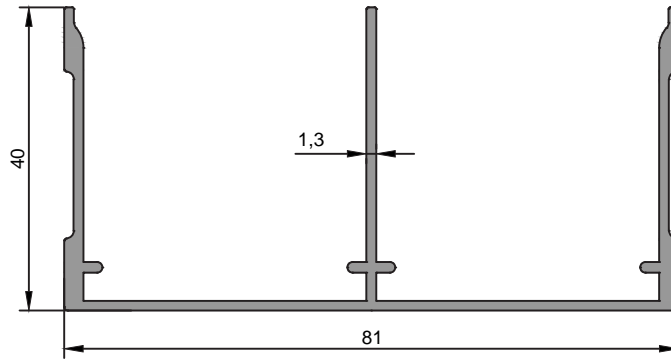

1684
0,822 kg/m

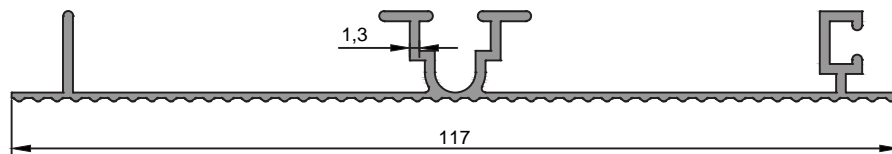

2032
0,530 kg/m

MOBİLYA PROFİLLERİ

FURNITURE PROFILES

★ Yandaki profil birim ağırlıkları, bilgisayarda hesaplanmış teorik ağırlıklardır.

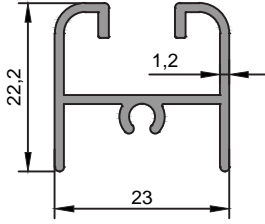

1741

0,294 kg/m

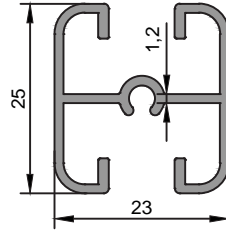

1742

0,360 kg/m

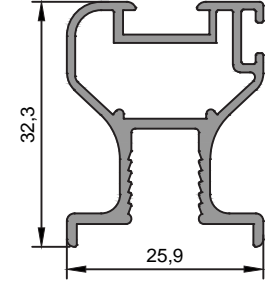

1530

0,549 kg/m

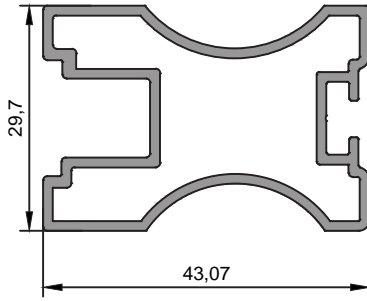

1638

0,676 kg/m

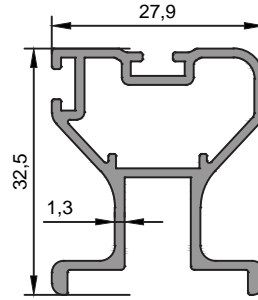

1736

0,488 kg/m

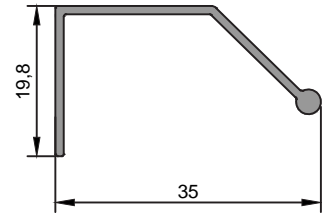

1688

0,187 kg/m

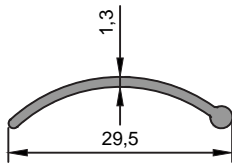

1708

0,119 kg/m

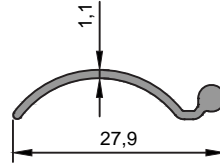

1710

0,112 kg/m

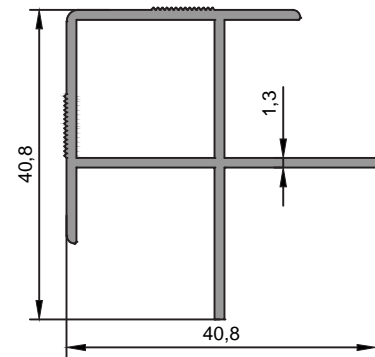

1814

0,491 kg/m

MOBİLYA PROFİLLERİ

FURNITURE PROFILES

★ Yandaki profil birim ağırlıkları, bilgisayarla hesaplanmış teorik ağırlıklardır.

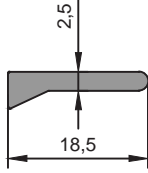

1712
0,141 kg/m

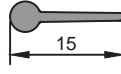

1709
0,68 kg/m

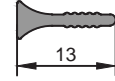

1711
0,71 kg/m

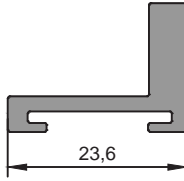

1714
0,346 kg/m

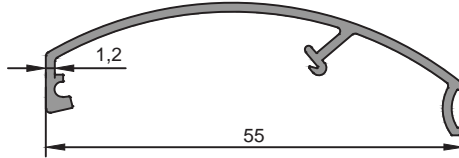

1460
0,279 kg/m

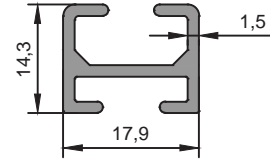

1428
0,249 kg/m

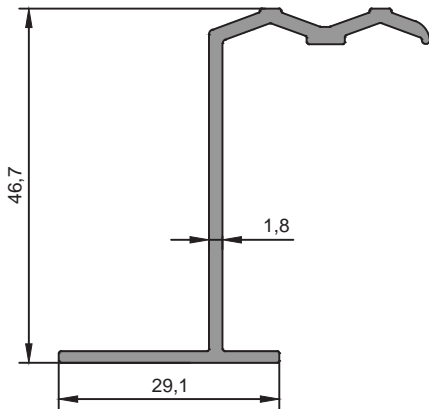

1687
0,479 kg/m

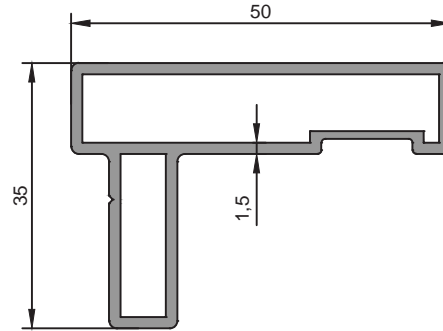

1293
0,683 kg/m

★ Yandaki profil birim ağırlıkları, bilgisayarda hesaplanmış teorik ağırlıklardır.

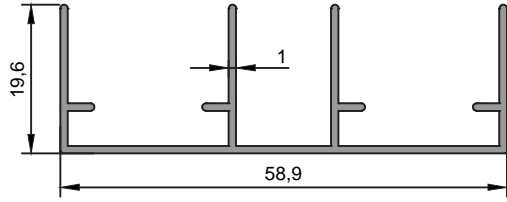

1597
0,396 kg/m

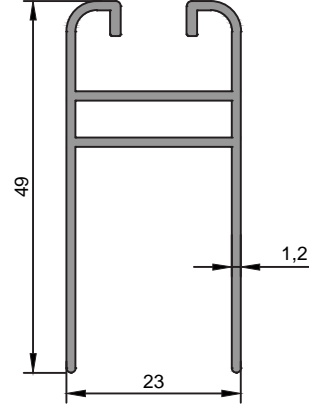

1743
0,506 kg/m

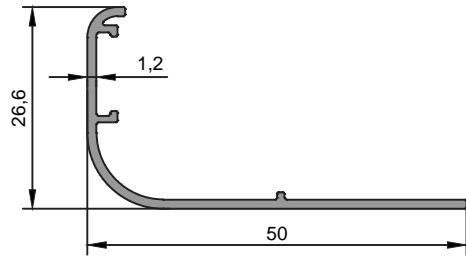

1713
0,259 kg/m

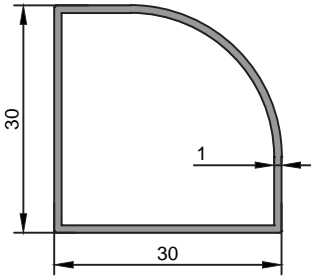

1898
0,291 kg/m

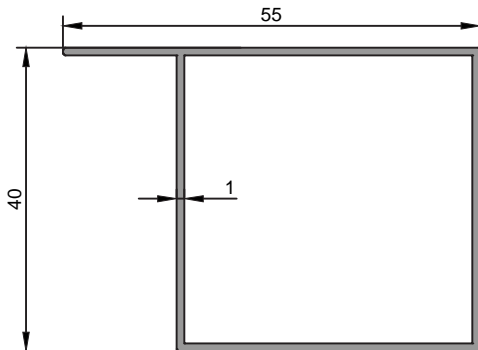

1899
0,463 kg/m

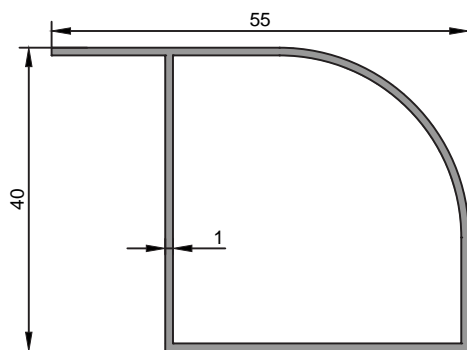

1900
0,434 kg/m

MOBİLYA PROFİLLERİ

FURNITURE PROFILES

★ Yandaki profil birim ağırlıkları, bilgisayararda hesaplanmış teorik ağırlıklardır.

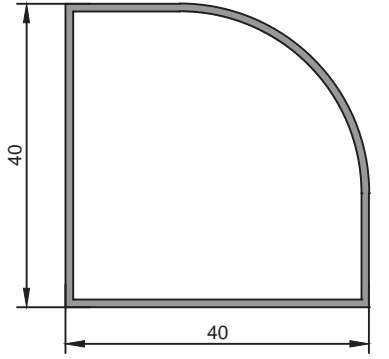

1901
0,394 kg/m

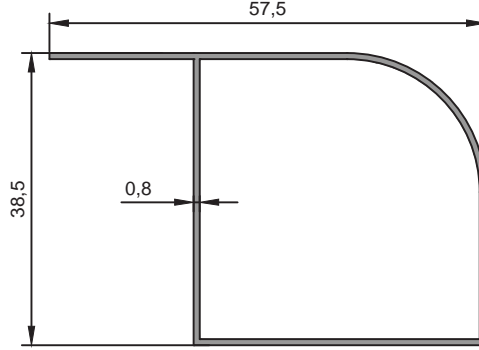

1306
0,351 kg/m

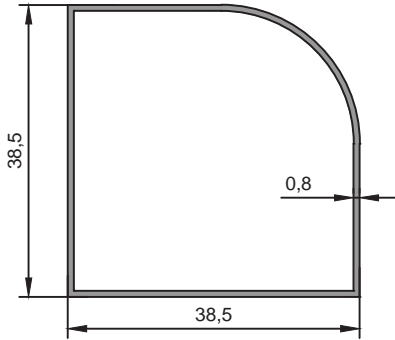

1307
0,310 kg/m

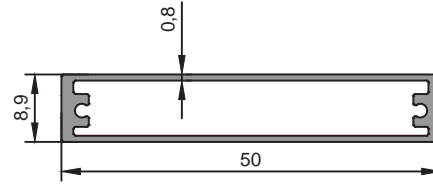

1727
0,312 kg/m

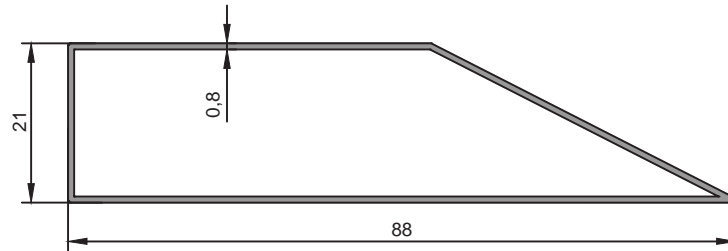

1427
0,430 kg/m

PROFİL KATALOĞU

SERAMİK PROFİLLERİ

CERAMIC PROFILES

* Profil Ağırlıkları Teorik Olup Teslim Anındaki Ağırlık Geçerlidir

* *Weight of profiles are theoretical, net weight will valid at the time of delivery.*

SERAMİK PROFİLLERİ

CERAMIC PROFILES











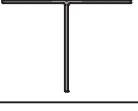
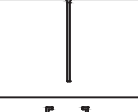
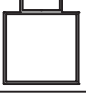

★ Yandaki profil birim ağırlıkları, bilgisayarda hesaplanmış teorik ağırlıklardır.

PROFİL KESİTİ	PROFİL KODU	PROFİL ADI	AĞIRLIK	ATALET MOMENTLERİ		SAYFA NO
				J_x (cm ⁴)	J_y (cm ⁴)	
	1755	...	0,290 kg/m	
	1756	...	0,319 kg/m	
	1121	...	0,486 kg/m	
	1222	...	0,490 kg/m	
	1831	...	1,199 kg/m	
	1832	...	0,235 kg/m	
	1833	...	0,293 kg/m	
	1834	...	0,288 kg/m	
	2842	...	0,947 kg/m	
	1255	...	0,603 kg/m	
	1477	...	0,956 kg/m	
	1394	...	0,479 kg/m	
	1801	...	0,801 kg/m	
	1840	...	0,308 kg/m	

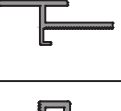
SERAMİK PROFİLLERİ

CERAMIC PROFILES











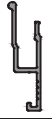

★ Yandaki profil birim ağırlıkları, bilgisayarda hesaplanmış teorik ağırlıklardır.

PROFİL KESİTİ	PROFİL KODU	PROFİL ADI	AĞIRLIK	ATALET MOMENTLERİ		SAYFA NO
				J_x (cm ⁴)	J_y (cm ⁴)	
	1033	...	0,421 kg/m	
	1592	...	0,569 kg/m	
	1747	...	0,558 kg/m	
	1170	...	0,578 kg/m	
	1158	...	0,560 kg/m	
	1797	...	0,742 kg/m	
	1192	...	1,093 kg/m	
	1193	...	0,280 kg/m	
	1884	...	0,448 kg/m	
	1882	...	0,278 kg/m	
	1883	...	0,318 kg/m	
	1543	...	0,427 kg/m	
	1544	...	0,297 kg/m	
	1358	...	0,226 kg/m	

SERAMİK PROFİLLERİ

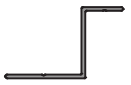
CERAMIC PROFILES













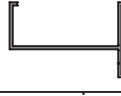

★ Yandaki profil birim ağırlıkları, bilgisayarda hesaplanmış teorik ağırlıklardır.

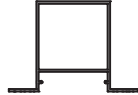
PROFİL KESİTİ	PROFİL KODU	PROFİL ADI	AĞIRLIK	ATALET MOMENTLERİ		SAYFA NO
				J_x (cm ⁴)	J_y (cm ⁴)	
	1733	...	0,477 kg/m	
	1734	...	0,553 kg/m	
	1753	...	0,700 kg/m	
	1476	...	0,220 kg/m	
	1261	...	1,329 kg/m	
	1335	...	0,433 kg/m	
	1464	...	0,435 kg/m	
	1649	...	0,278 kg/m	
	1364	...	0,333 kg/m	
	1366	...	0,133 kg/m	
	1754	...	0,718 kg/m	
	1566	...	0,696 kg/m	
	1565	...	1,051 kg/m	
	1316	...	0,563 kg/m	

SERAMİK PROFİLLERİ

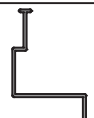
CERAMIC PROFILES

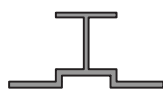
★ Yandaki profil birim ağırlıkları, bilgisayarda hesaplanmış teorik ağırlıklardır.

PROFİL KESİTİ	PROFİL KODU	PROFİL ADI	AĞIRLIK	ATALET MOMENTLERİ		SAYFA NO
				J_x (cm ⁴)	J_y (cm ⁴)	
	1748	...	0,394 kg/m	
	1368	...	0,394 kg/m	
	1692	...	0,540 kg/m	
	1682	...	0,139 kg/m	
	1355	...	0,541 kg/m	
	1354	...	0,751 kg/m	
	2098	...	1,095 kg/m	
	1632	...	1,407 kg/m	
	1482	...	1,449 kg/m	
	1798	...	1,215 kg/m	
	1978	...	0,517 kg/m	
	3776	...	0,494 kg/m	
	3777	...	0,269 kg/m	
	3778	...	0,378 kg/m	

SERAMİK PROFİLLERİ

CERAMIC PROFILES









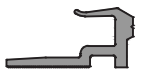

★ Yandaki profil birim ağırlıkları, bilgisayarda hesaplanmış teorik ağırlıklardır.

PROFİL KESİTİ	PROFİL KODU	PROFİL ADI	AĞIRLIK	ATALET MOMENTLERİ		SAYFA NO
				J_x (cm ⁴)	J_y (cm ⁴)	
	3192	...	0,910 kg/m	
	3220	...	0,484 kg/m	
	3221	...	0,268 kg/m	
	3222	...	0,220 kg/m	
	3668	...	0,563 kg/m	
	3748	...	0,748 kg/m	
	3802	...	1,257 kg/m	
	3954	...	0,334 kg/m	
	3955	...	0,436 kg/m	
	3999	...	0,708 kg/m	
	4015	...	0,461 kg/m	
	4016	...	0,488 kg/m	
	4798	...	0,131 kg/m	
	4068	...	0,640 kg/m	

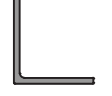
SERAMİK PROFİLLERİ

CERAMIC PROFILES

★ Yandaki profil birim ağırlıkları, bilgisayarda hesaplanmış teorik ağırlıklardır.

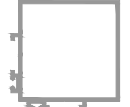
PROFİL KESİTİ	PROFİL KODU	PROFİL ADI	AĞIRLIK	ATALET MOMENTLERİ		SAYFA NO
				J_x (cm ⁴)	J_y (cm ⁴)	
	2637	...	0,954 kg/m	
	2999	...	0,594 kg/m	
	2634	...	0,909 kg/m	
	2635	...	1,500 kg/m	
	2636	...	1,074 kg/m	
	1365	...	1,168 kg/m	
	1367	...	1,379 kg/m	
	1369	...	1,802 kg/m	
	1370	...	1,590 kg/m	
	2900	...	0,353 kg/m	
	2901	...	0,297 kg/m	
	3025	...	0,871 kg/m	
	3026	...	1,531 kg/m	
	3222	...	0,220 kg/m	

SERAMİK PROFİLLERİ

CERAMIC PROFILES

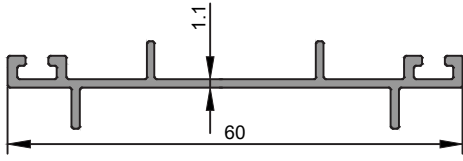

1755

0,290 kg/m

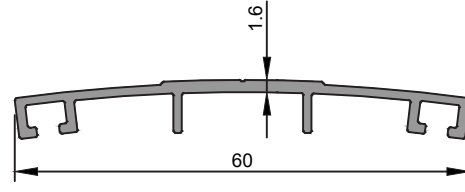

1756

0,319 kg/m

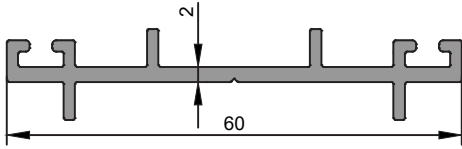

1121

0,486 kg/m

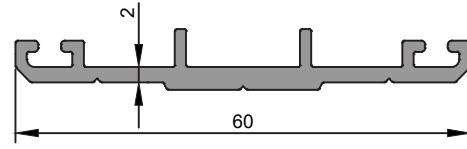

1222

0,490 kg/m

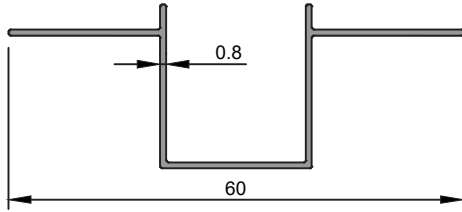

1831

0,220 kg/m

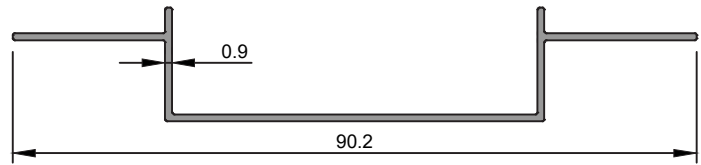

1834

0,288 kg/m

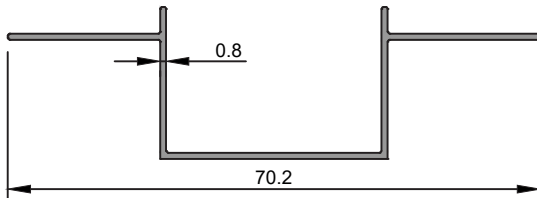

1832

0,235 kg/m

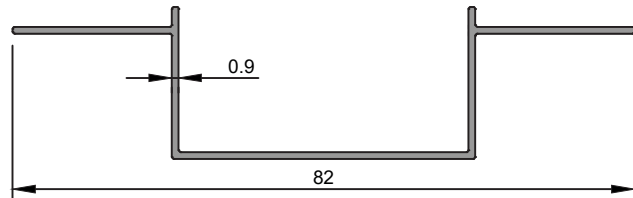

1833

0,293 kg/m

★ Yandaki profil birim ağırlıkları, bilgisayarda hesaplanmış teorik ağırlıklardır.

SERAMİK PROFİLLERİ

CERAMIC PROFILES

★ Yandaki profil birim ağırlıkları, bilgisayarla hesaplanmış teorik ağırlıklardır.

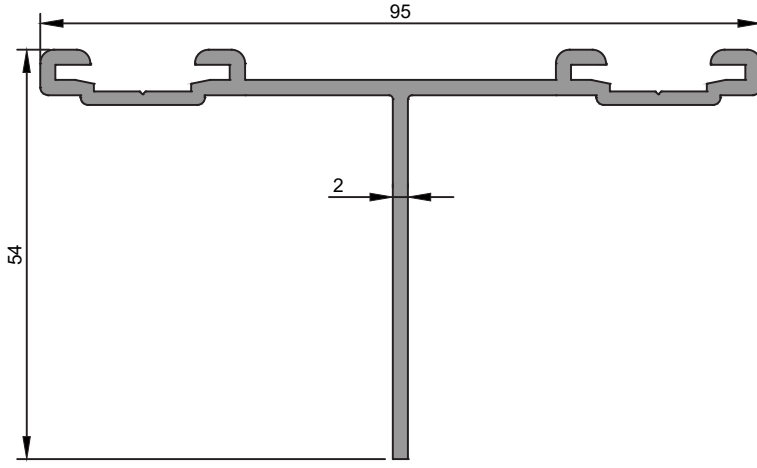

1060
0,947 kg/m

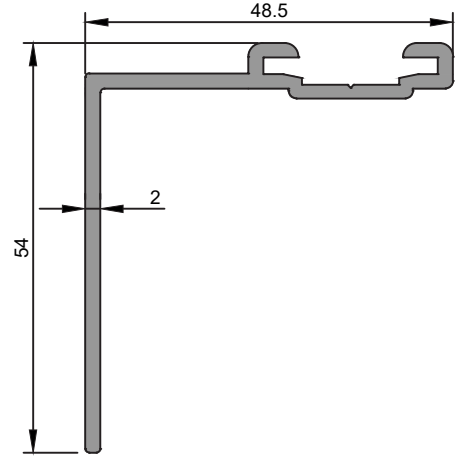

1255
0,603 kg/m

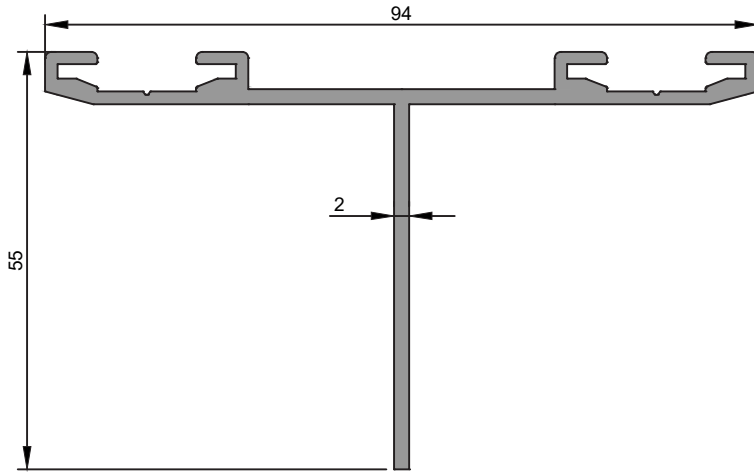

1477
0,956 kg/m

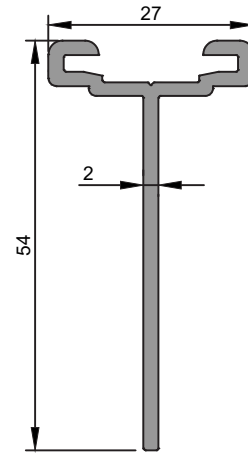

1394
0,479 kg/m

SERAMİK PROFİLLERİ

CERAMIC PROFILES

★ Yandaki profil birim ağırlıklar, bilgisayarla hesaplanmış teorik ağırlıklardır.

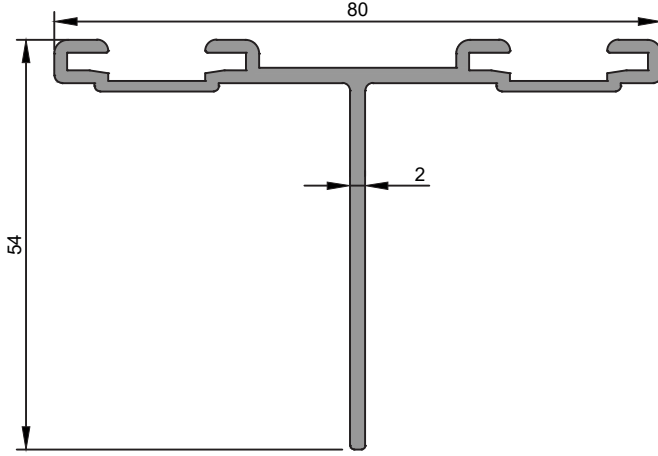

1801
0,805 kg/m

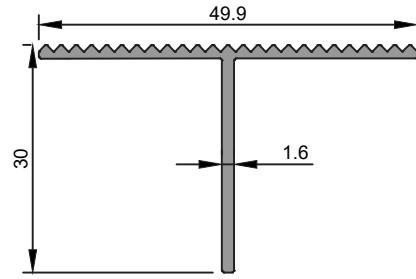

1840
0,308 kg/m

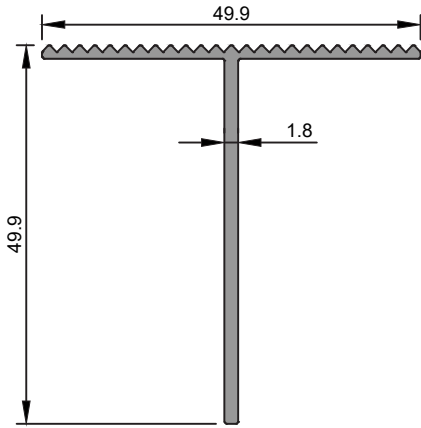

1033
0,421 kg/m

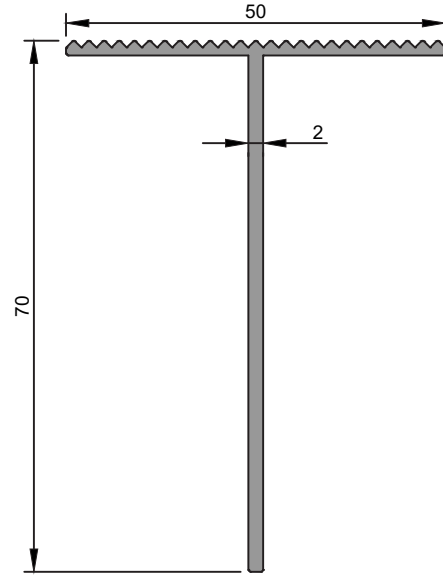

1592
0,569 kg/m

SERAMİK PROFİLLERİ

CERAMIC PROFILES

★ Yandaki profil birim ağırlıkları, bilgisayarda hesaplanmış teorik ağırlıklardır.

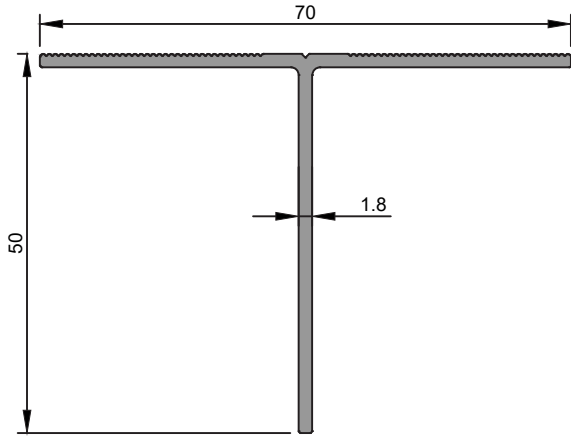

1747
0,558 kg/m

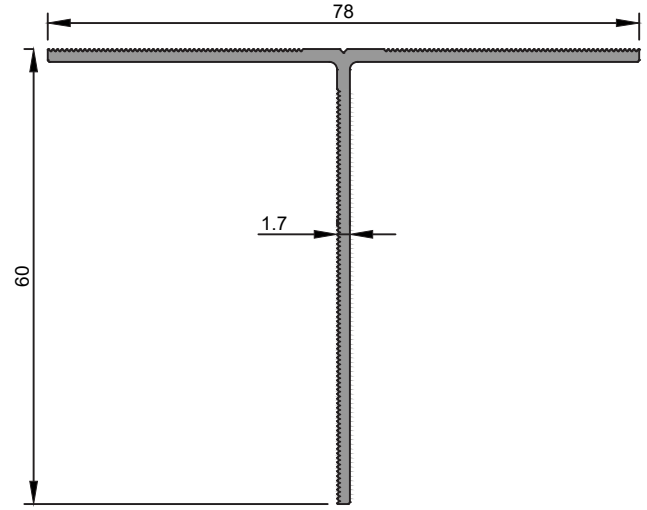

1170
0,578 kg/m

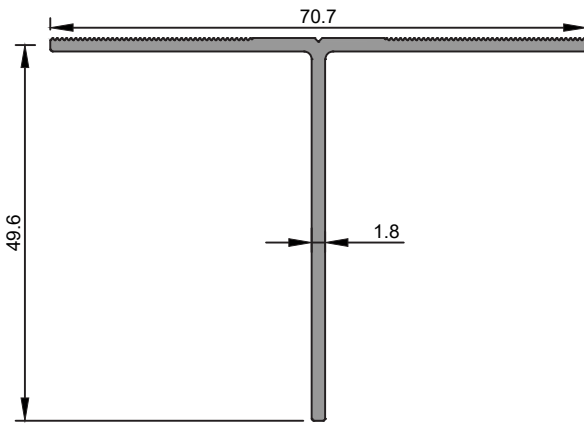

1158
0,560 kg/m

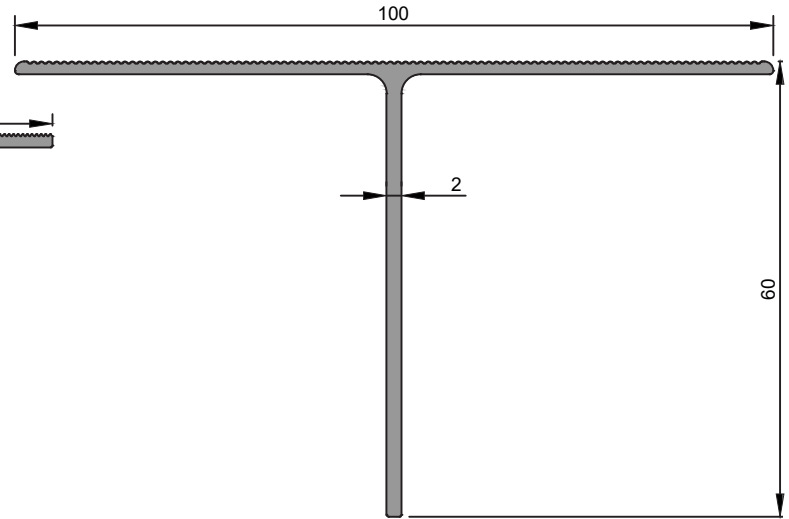

1797
0,742 kg/m

SERAMİK PROFİLLERİ

CERAMIC PROFILES

★ Yandaki profil birim ağırlıkları, bilgisayarla hesaplanmış teorik ağırlıklardır.

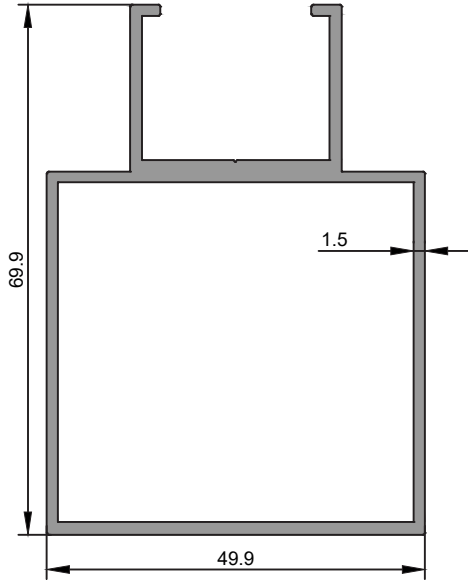

1192

1,093 kg/m

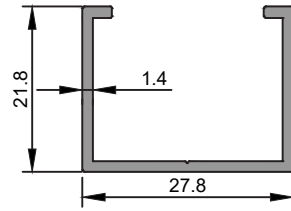

1193

0,280 kg/m

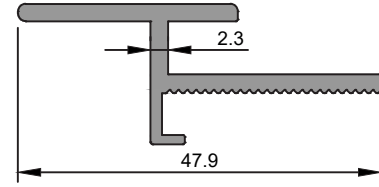

1884

0,448 kg/m

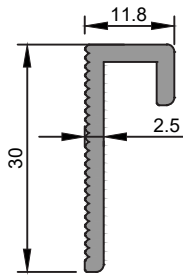

1882

0,278 kg/m

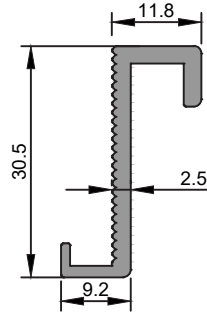

1883

0,318 kg/m

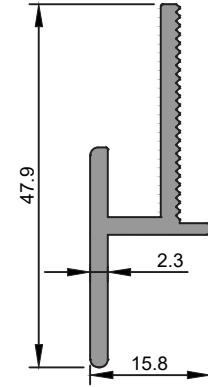

1543

0,427 kg/m

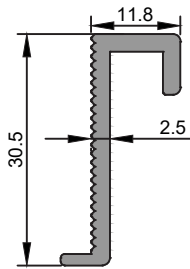

1544

0,297 kg/m

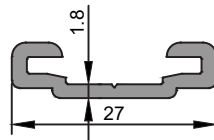

1358

0,226 kg/m

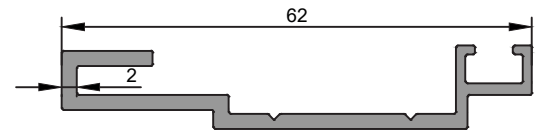

1733

0,477 kg/m

SERAMİK PROFİLLERİ

CERAMIC PROFILES

★ Yandaki profil birim ağırlıkları, bilgisayarda hesaplanmış teorik ağırlıklardır.

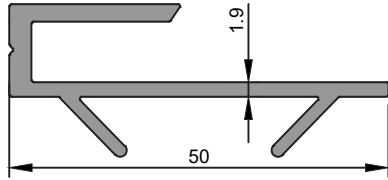

1734

0,553 kg/m

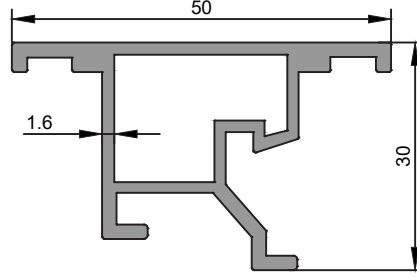

1753

0,700 kg/m

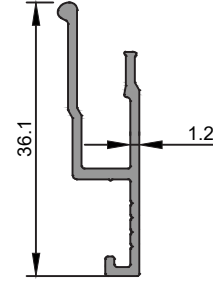

1476

0,220 kg/m

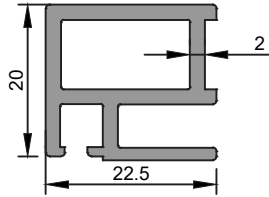

1261

1,329 kg/m

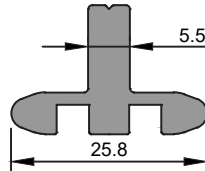

1335

0,433 kg/m

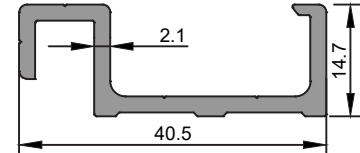

1464

0,435 kg/m

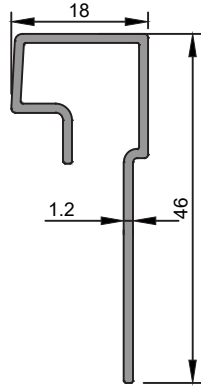

1649

0,278 kg/m

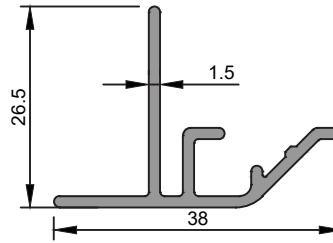

1364

0,333 kg/m

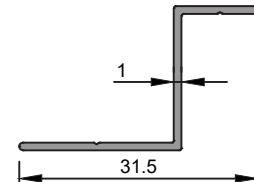

1366

0,133 kg/m

SERAMİK PROFİLLERİ

CERAMIC PROFILES

★ Yandaki profil birim ağırlıklar, bilgisayarla hesaplanmış teorik ağırlıklardır.

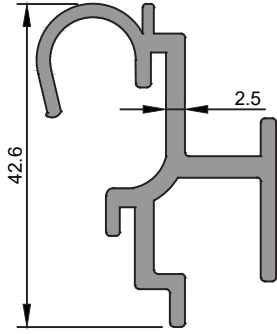

1754
0,718 kg/m

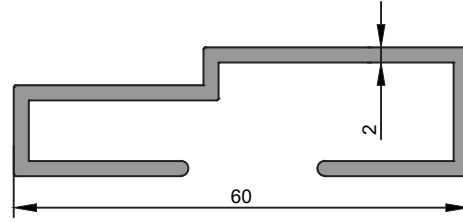

1566
0,696 kg/m

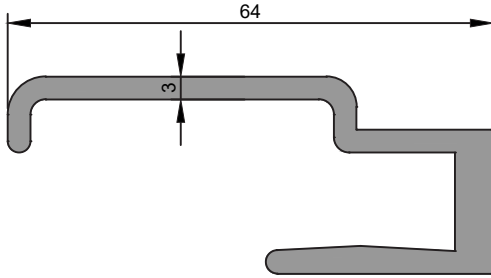

1565
1,051 kg/m

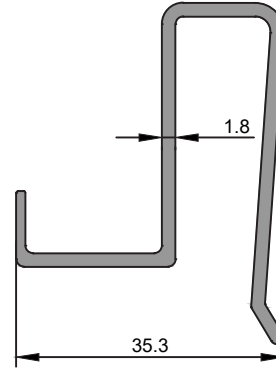

1316
0,563 kg/m

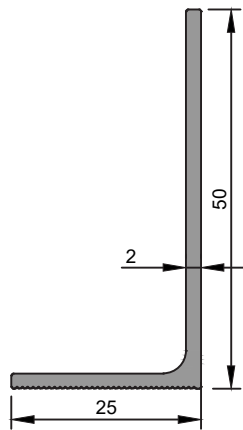

1748
0,394 kg/m

★ Yandaki profil birim ağırlıkları, bilgisayarla hesaplanmış teorik ağırlıklardır.

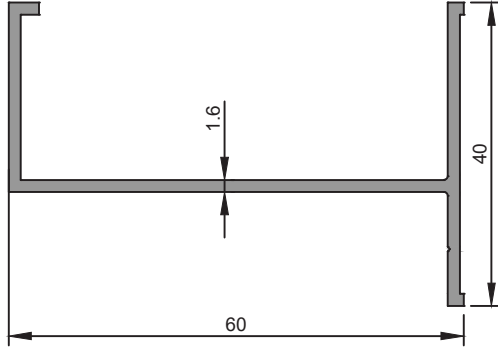

1692
0,540 kg/m

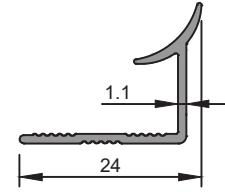

1682
0,139 kg/m

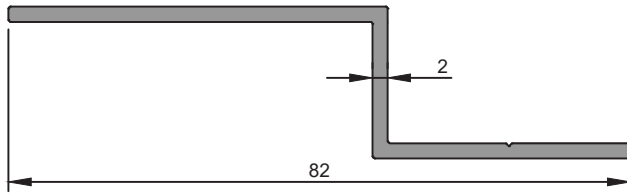

1355
0,541 kg/m

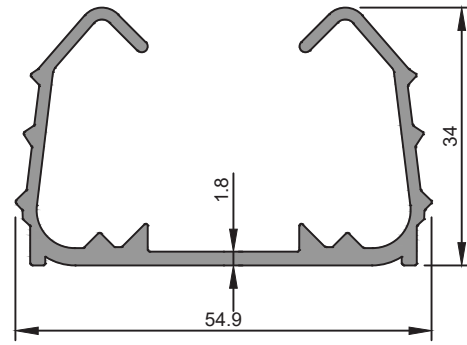

1354
0,751 kg/m

SERAMİK PROFİLLERİ

CERAMIC PROFILES

★ Yandaki profil birim ağırlıkları, bilgisayarda hesaplanmış teorik ağırlıklardır.

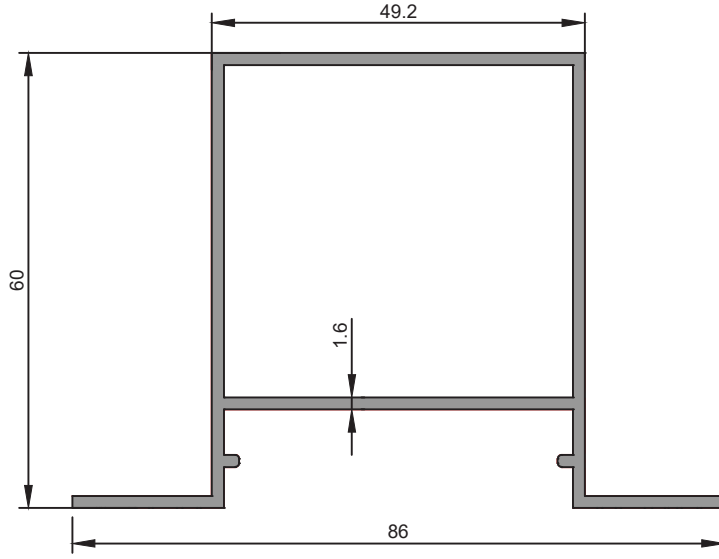

2098
1,095 kg/m

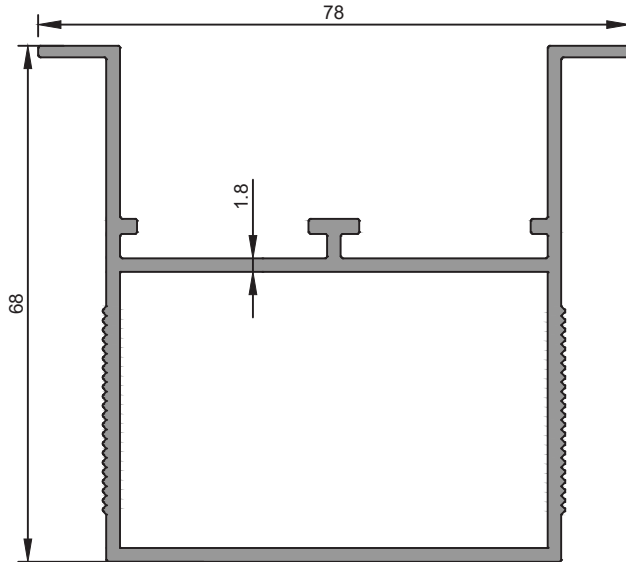

1632
1,407 kg/m

SERAMİK PROFİLLERİ

CERAMIC PROFILES

★ Yandaki profil birim ağırlıkları, bilgisayararda hesaplanmış teorik ağırlıklardır.

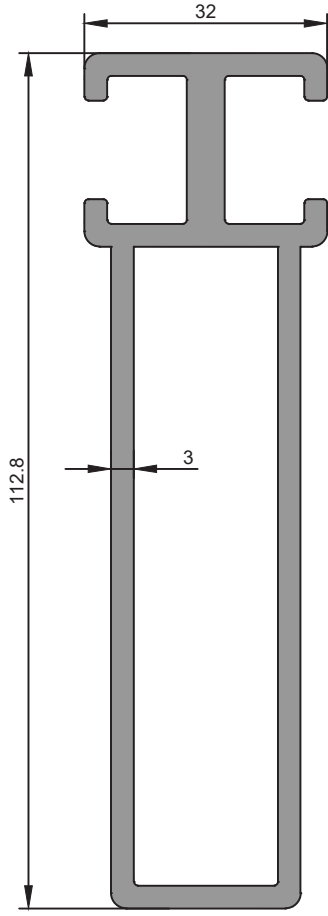

1482
1,449 kg/m

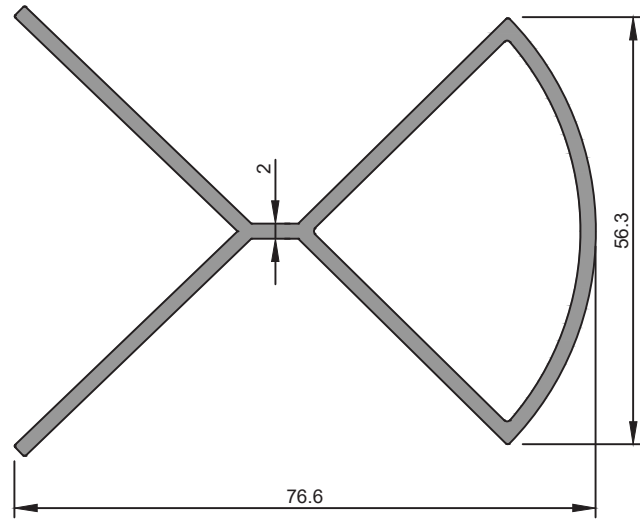

1798
1,215 kg/m

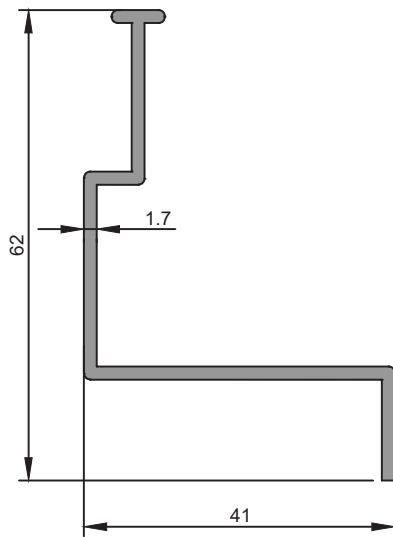

1978
0,517 kg/m

SERAMİK PROFİLLERİ

CERAMIC PROFILES

★ Yandaki profil birim ağırlıklar, bilgisayarda hesaplanmış teorik ağırlıklardır.

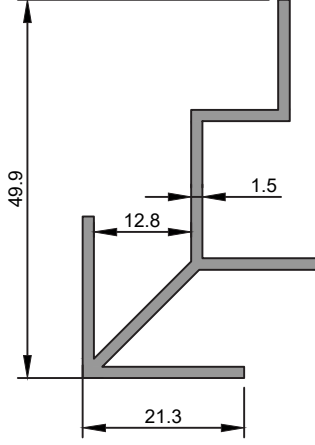

3776
0,494 kg/m

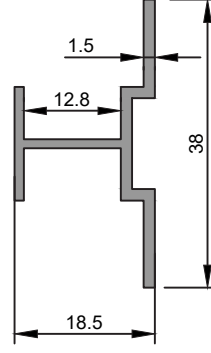

3777
0,269 kg/m

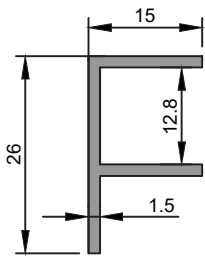

3778
0,217 kg/m

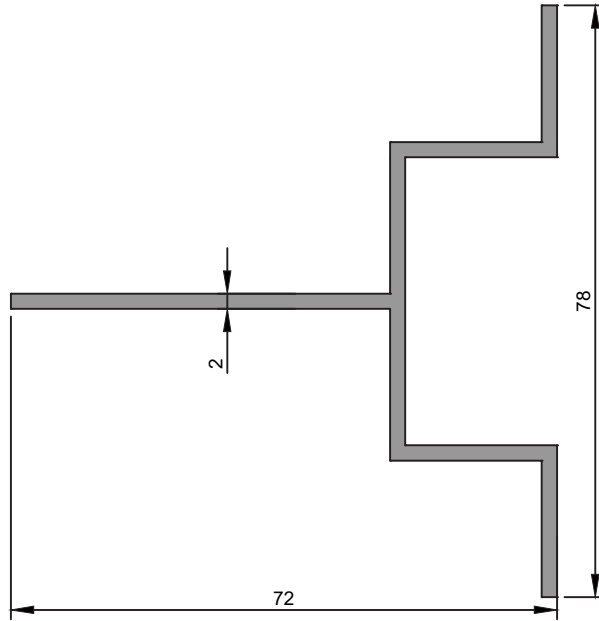

3192
0,910 kg/m

★ Yandaki profil birim ağırlıkları, bilgisayarla hesaplanmış teorik ağırlıklardır.

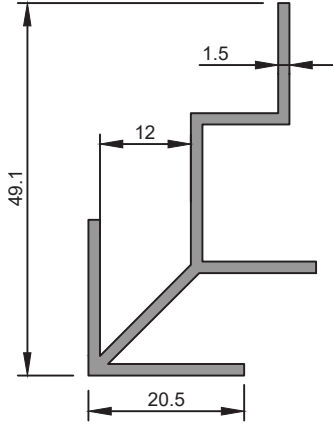

3220
0,484 kg/m

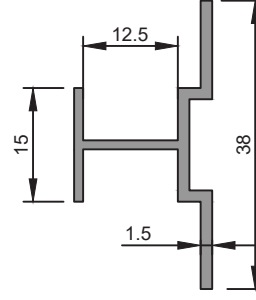

3221
0,268 kg/m

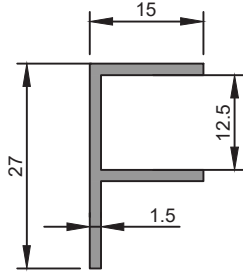

3222
0,220 kg/m

SERAMİK PROFİLLERİ

CERAMIC PROFILES

★ Yandaki profil birim ağırlıkları, bilgisayarda hesaplanmış teorik ağırlıklardır.

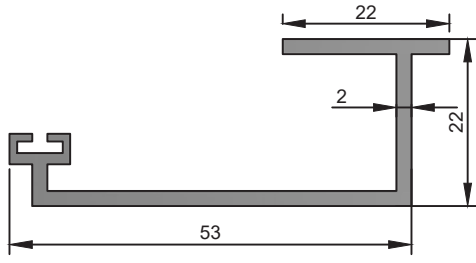

3668
0,563 kg/m

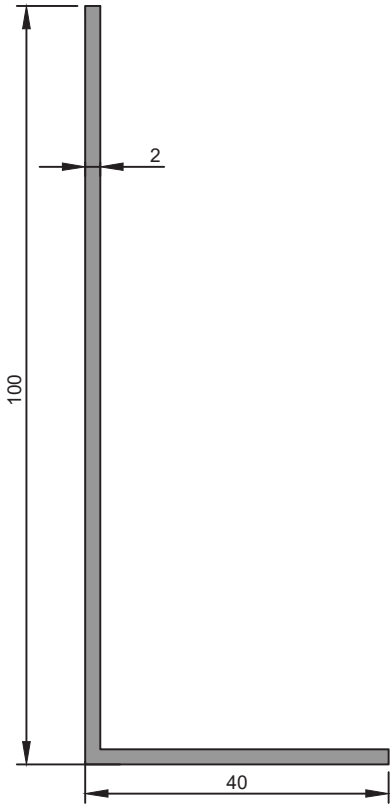

3748
0,748 kg/m

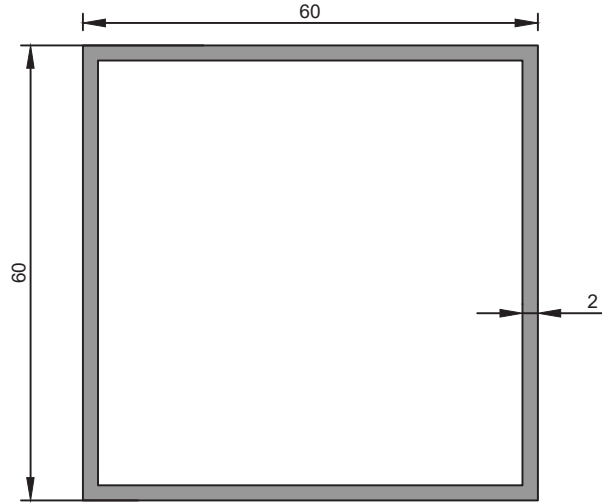

3802
1,257 kg/m

SERAMİK PROFİLLERİ

CERAMIC PROFILES

★ Yandaki profil birim ağırlıkları, bilgisayararda hesaplanmış teorik ağırlıklardır.

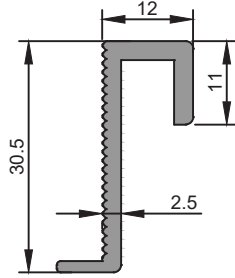

3954

0,334 kg/m

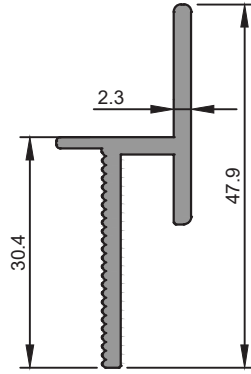

3955

0,436 kg/m

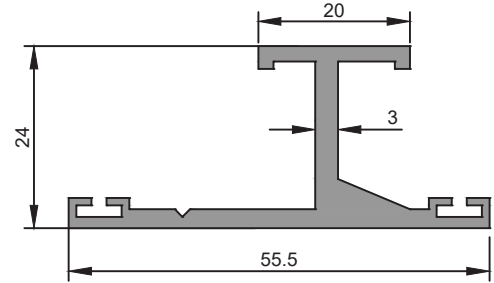

3999

0,708 kg/m

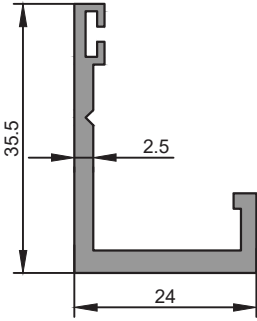

4015

0,461 kg/m

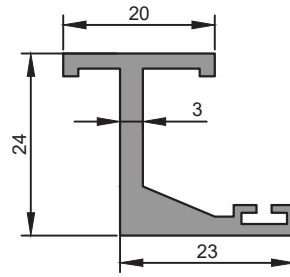

4016

0,488 kg/m

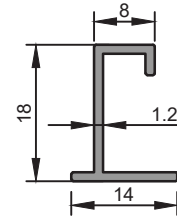

4798

0,131 kg/m

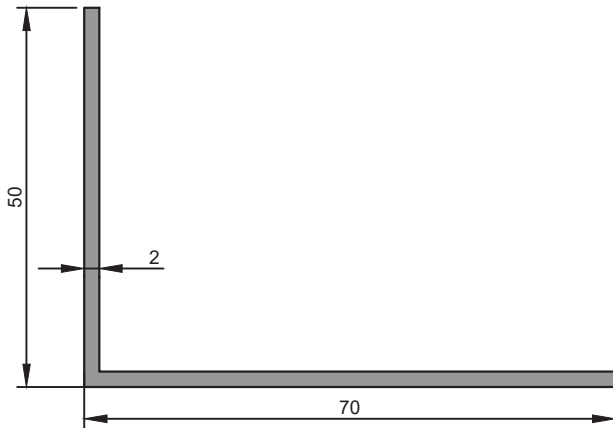

4068

0,640 kg/m

SERAMİK PROFİLLERİ

CERAMIC PROFILES

★ Yandaki profil birim ağırlıklar, bilgisayarda hesaplanmış teorik ağırlıklardır.

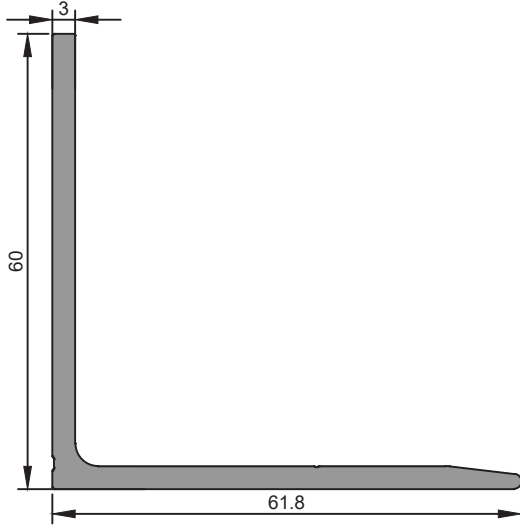

2637

0,954 kg/m

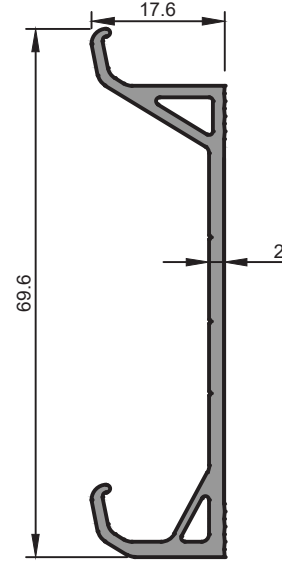

2999

0,594 kg/m

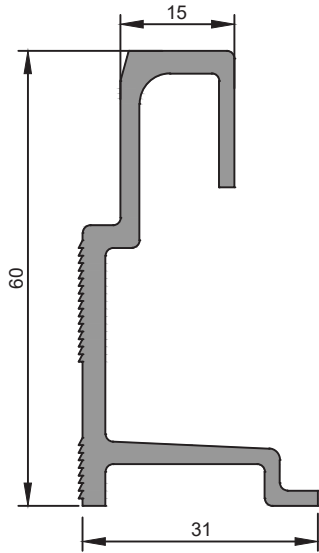

2634

0,909 kg/m

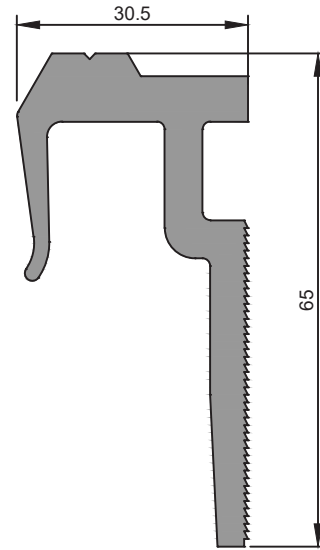

2635

1,500 kg/m

★ Yandaki profil birim ağırlıkları, bilgisayarda hesaplanmış teorik ağırlıklardır.

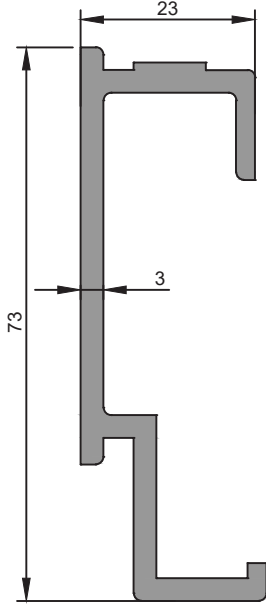

2636
1,074 kg/m

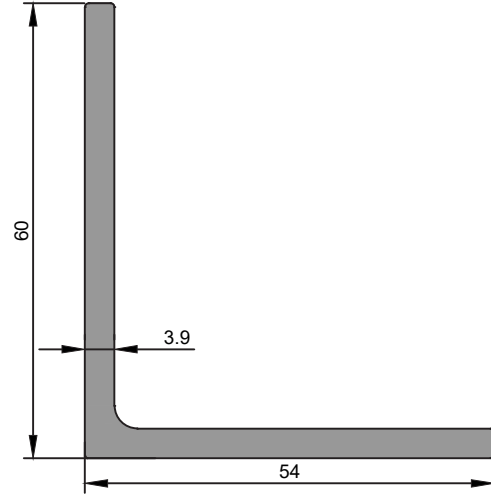

1365
1,168 kg/m

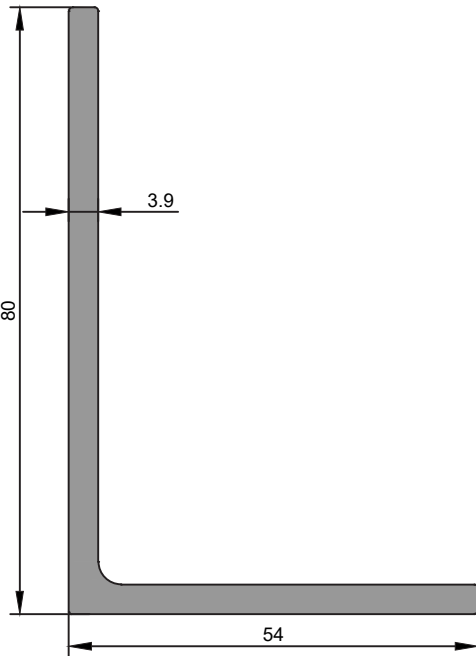

1367
1,379 kg/m

SERAMİK PROFİLLERİ

CERAMIC PROFILES

★ Yandaki profil birim ağırlıkları, bilgisayarda hesaplanmış teorik ağırlıklardır.

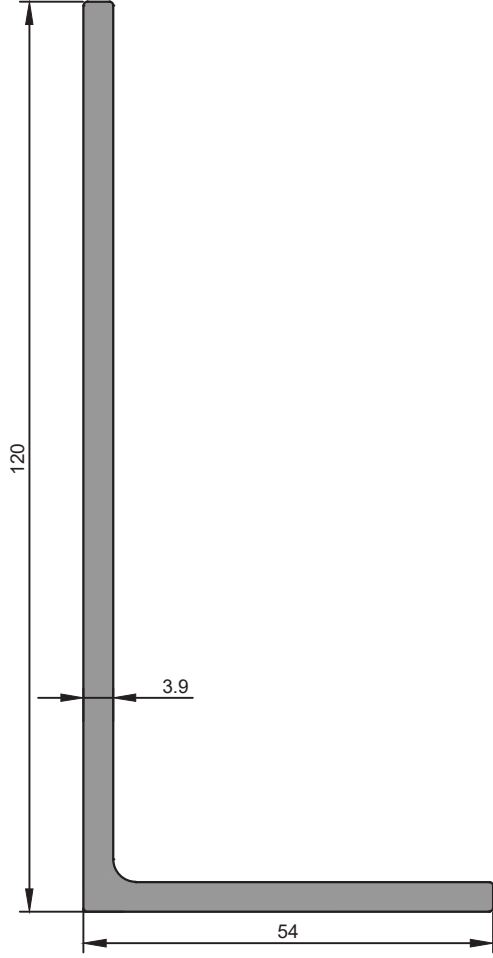

1369
1,802 kg/m

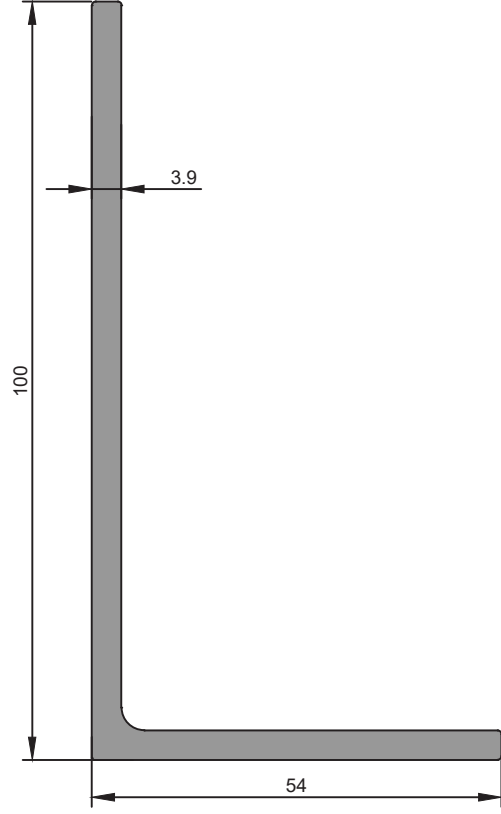

1370
1,590 kg/m

SERAMİK PROFİLLERİ

CERAMIC PROFILES

★ Yandaki profil birim ağırlıkları, bilgisayarla hesaplanmış teorik ağırlıklardır.

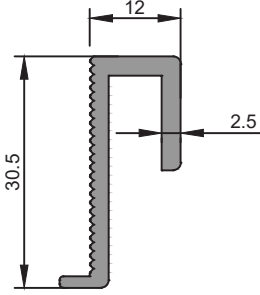

2900

0,353 kg/m

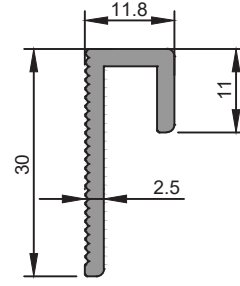

2901

0,297 kg/m

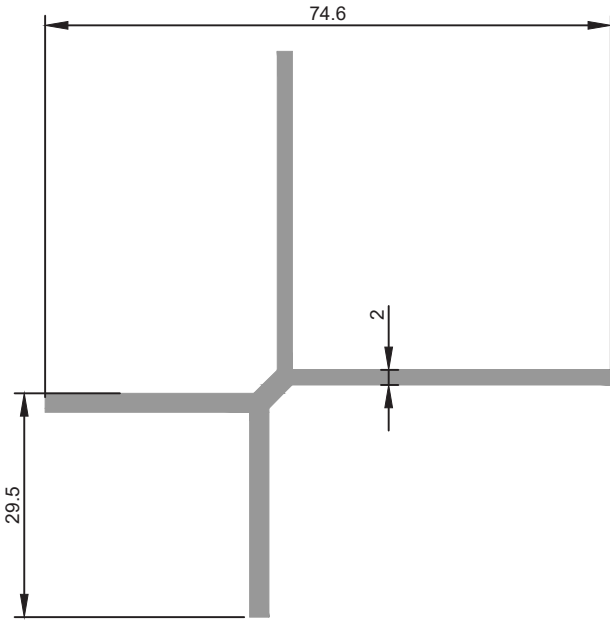

3025

0,871 kg/m

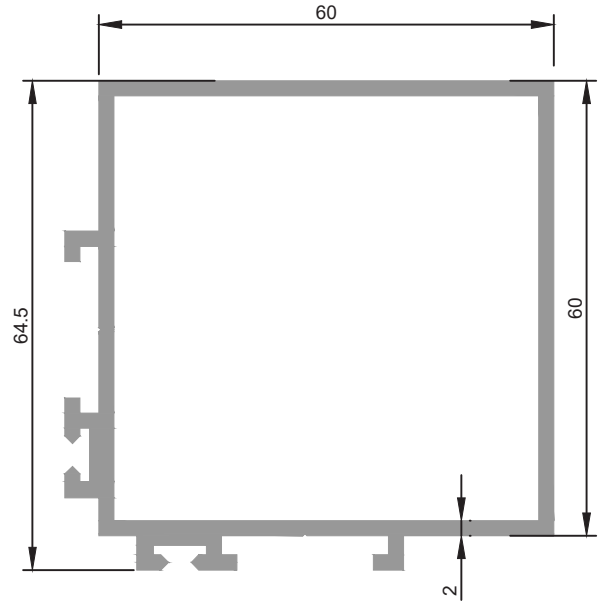

3026

1,531 kg/m

SERAMİK PROFİLLERİ

CERAMIC PROFILES

★ Yandaki profil birim ağırlıkları, bilgisayarda hesaplanmış teorik ağırlıklardır.

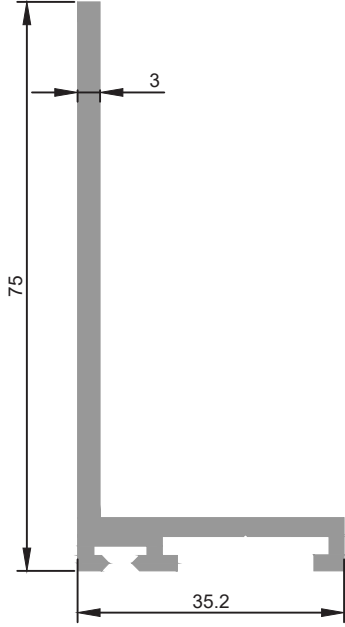

3027

0,928 kg/m

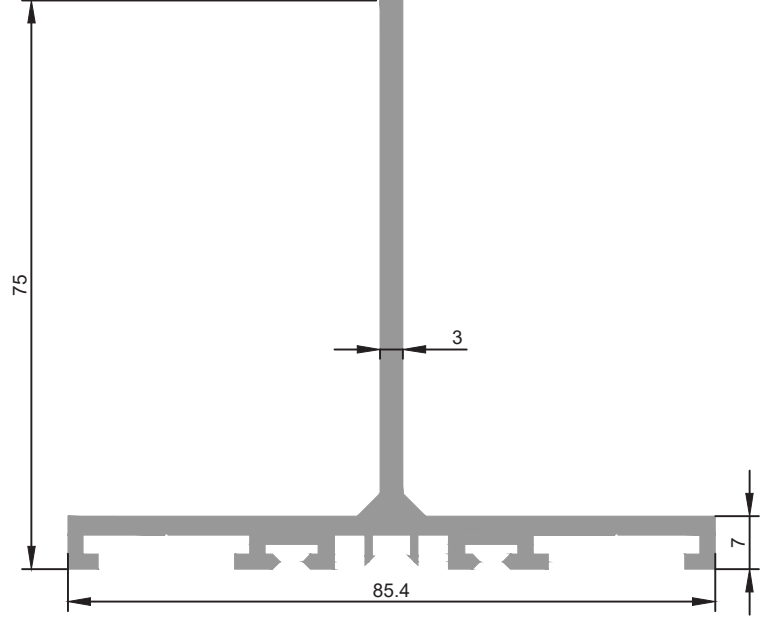

3028

1,448 kg/m

PROFİL KATALOĐU

TEMİZ ODA PROFİLLERİ

COOLING ROOM PROFILES







* Profil Ağırlıkları Teorik Olup Teslim Anındaki Ağırlık Geçerlidir

* *Weight of profiles are theoretical, net weight will valid at the time of delivery.*

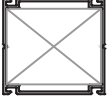
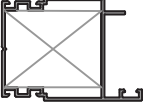
TEMİZ ODA PROFİLLERİ

COOLING ROOM PROFILES

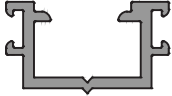
★ Yandaki profil birim ağırlıkları, bilgisayarda hesaplanmış teorik ağırlıklardır.

PROFİL KESİTİ	PROFİL KODU	PROFİL ADI	AĞIRLIK	ATALET MOMENTLERİ		SAYFA NO
				J_x (cm ⁴)	J_y (cm ⁴)	
	3486	Panel Kasa	0,945 kg/m	15,95	14,21	
	3485	Panel Kapı	1,197 kg/m	26,67	18,52	
	3487	Kapı Çıtası	0,257 kg/m	
	3489	Orta Kayıt Çıtası	0,538 kg/m	
	3294	Cam Arası Kapağı	0,127 kg/m	
	3297	Cam Arası Kapağı	0,382 kg/m	
	2916	Köşe Takoza	4,919 kg/m	

TEMİZ ODA PROFİLLERİ

COOLING ROOM PROFILES

★ Yandaki profil birim ağırlıkları, bilgisayararda hesaplanmış teorik ağırlıklardır.

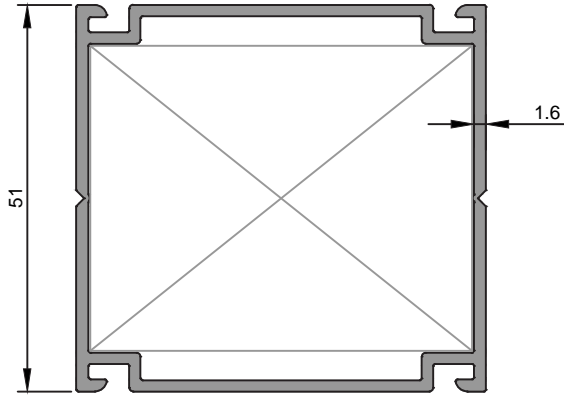

3486
Panel Kasa
0,945 kg/m
Jx=15,95 cm ⁴ Jy=14,21 cm ⁴

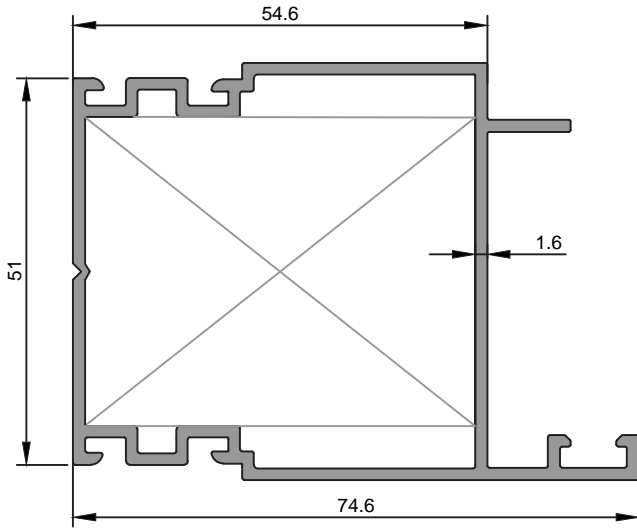

3485
Panel Kapı
1,197 kg/m
Jx=26,67 cm ⁴ Jy=18,52 cm ⁴

TEMİZ ODA PROFİLLERİ

COOLING ROOM PROFILES

★ Yandaki profil birim ağırlıkları, bilgisayarla hesaplanmış teorik ağırlıklardır.

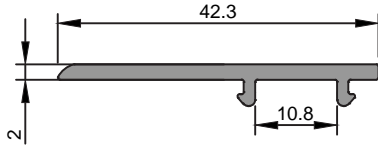

3487
Kapı Çıtası
0,257 kg/m

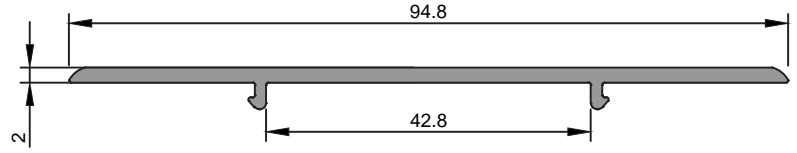

3489
Orta Kayıt Çıtası
0,538 kg/m

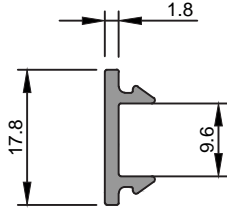

3294
Cam Arası Kapağı
0,127 kg/m

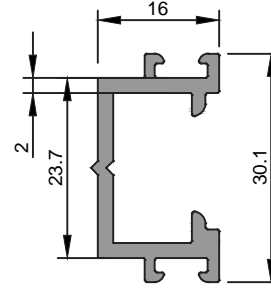

3297
Cam Arası Kapağı
0,382 kg/m

KÖŞE TAKOZU KESİM ÖLÇÜLERİ

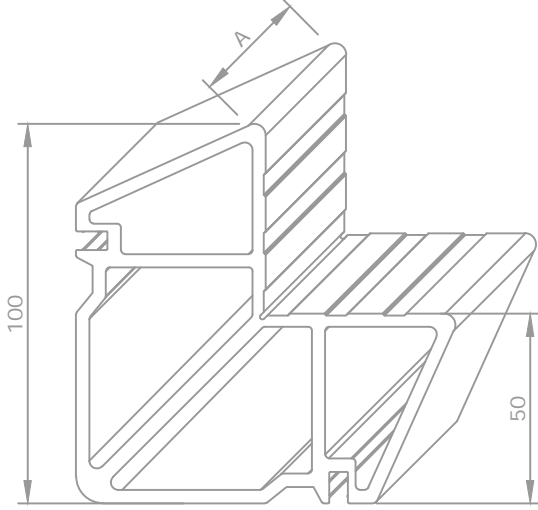

2916

Köşe Takozu

4,919 kg/m

Aksesuar Kodu	Profil Kodu	Kesim Ölçüsü A(mm)
K2916 402	3485	40.2
K2916 402	3486	40.2

★ Yandaki profil birim ağırlıkları, bilgisayarla hesaplanmış teorik ağırlıklardır.

DETAY-1
ÖLÇEK:1/1

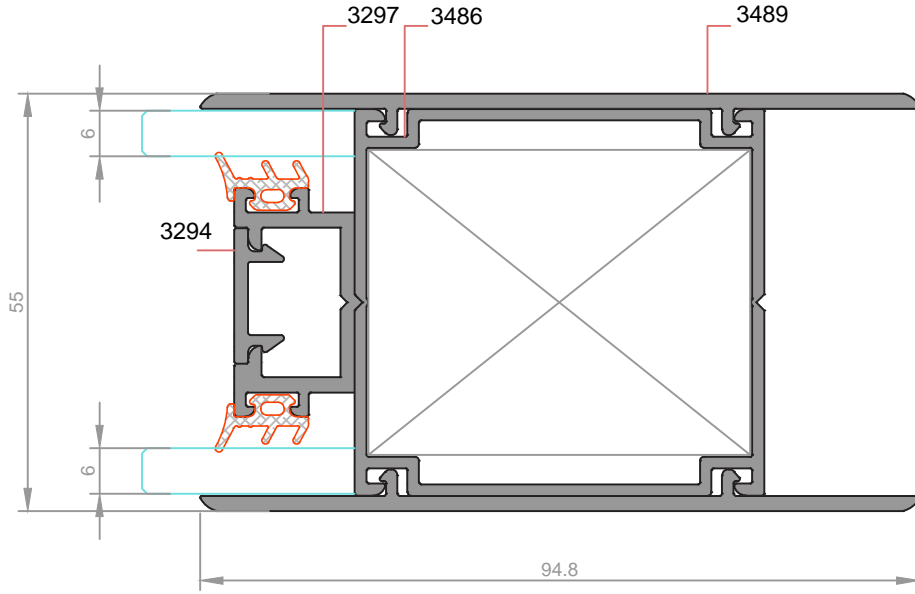

★ Yandaki profil birim ağırlıkları, bilgisayarda hesaplanmış teorik ağırlıklardır.

DETAY-2
ÖLÇEK:1/1

★ Yandaki profil birim ağırlıkları, bilgisayarda hesaplanmış teorik ağırlıklardır.

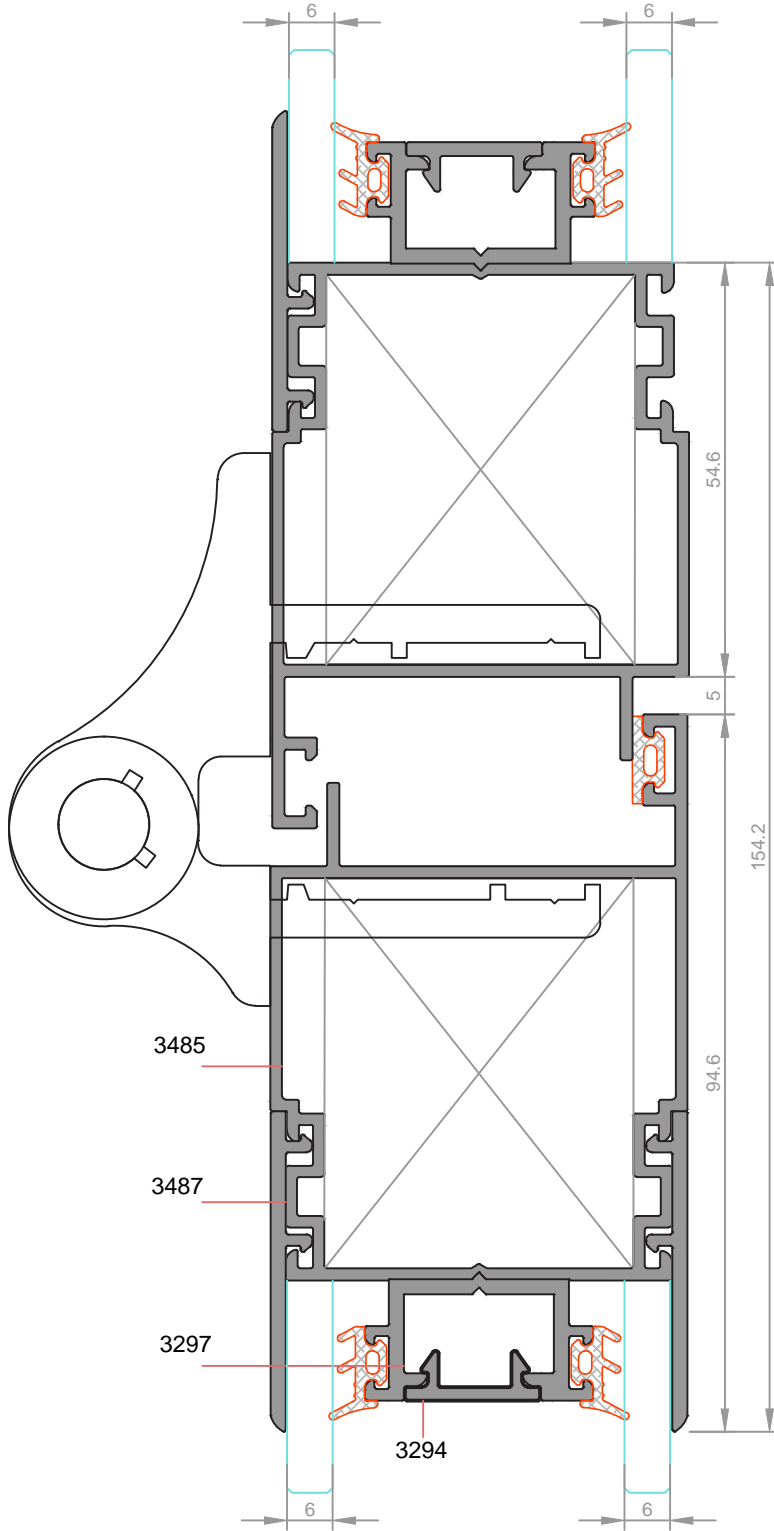

PROFİL KATALOĐU

VİTRİN PROFİLLERİ

SHOWCASE PROFILE









* Profil Ağırlıkları Teorik Olup Teslim Anındaki Ağırlık Geçerlidir

* *Weight of profiles are theoretical, net weight will valid at the time of delivery.*

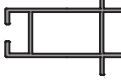
VİTRİN PROFİLLERİ

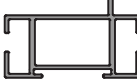
SHOWCASE PROFILE

★ Yandaki profil birim ağırlıkları, bilgisayarda hesaplanmış teorik ağırlıklardır.

PROFİL KESİTİ	PROFİL KODU	PROFİL ADI	AĞIRLIK	ATALET MOMENTLERİ		SAYFA NO
				J_x (cm ⁴)	J_y (cm ⁴)	
	1399	...	0,540 kg/m	
	1143	...	0,665 kg/m	
	1061	...	0,572 kg/m	
	1052	...	0,727 kg/m	
	1246	...	0,727 kg/m	
	1802	...	0,768 kg/m	
	1803	...	0,740 kg/m	
	1100	...	0,655 kg/m	
	1051	...	0,606 kg/m	
	1101	...	0,935 kg/m	

VİTRİN PROFİLLERİ

SHOWCASE PROFILE

★ Yandaki profil birim ağırlıkları, bilgisayarda hesaplanmış teorik ağırlıklardır.

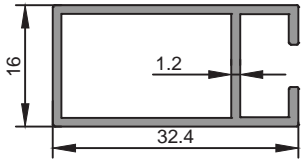

1399

0,540 kg/m

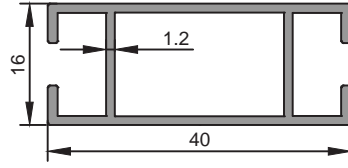

1143

0,665 kg/m

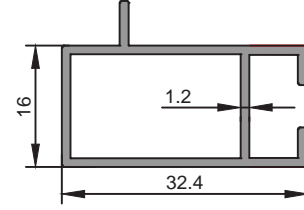

1061

0,572 kg/m

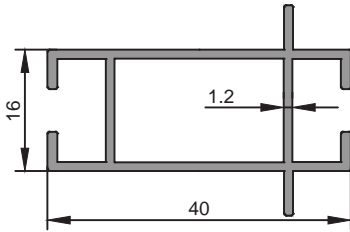

1052

0,727 kg/m

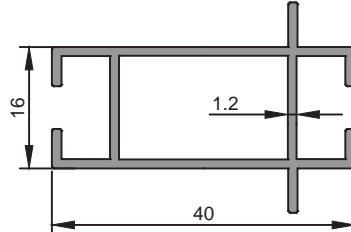

1246

0,727 kg/m

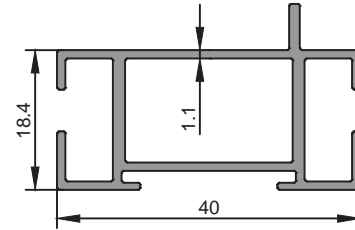

1802

0,768kg/m

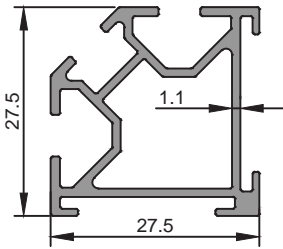

1803

0,740 kg/m

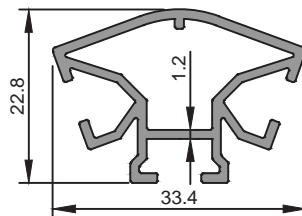

1100

0,655 kg/m

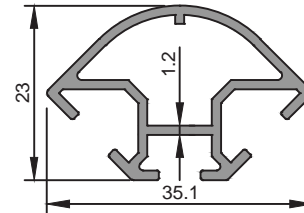

1051

0,606 kg/m

VİTRİN PROFİLLERİ

SHOWCASE PROFILE

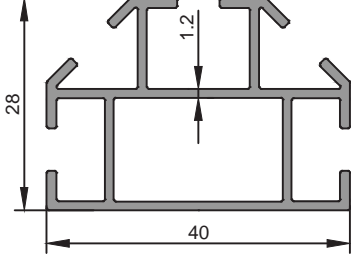

1101
0,935 kg/m

★ Yandaki profil birim ağırlıkları, bilgisayarda hesaplanmış teorik ağırlıklardır.

PROFİL KATALOĞU

GÜNEŞ KIRICI PROFİLLER

SUNBREAKER PROFILES







* Profil Ağırlıkları Teorik Olup Teslim Anındaki Ağırlık Geçerlidir

* *Weight of profiles are theoretical, net weight will valid at the time of delivery.*

GÜNEŞ KIRICI PROFİLLER

SUNBREAKER PROFILES

★ Yandaki profil birim ağırlıkları, bilgisayarda hesaplanmış teorik ağırlıklardır.

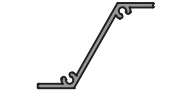
PROFİL KESİTİ	PROFİL KODU	PROFİL ADI	AĞIRLIK	ATALET MOMENTLERİ		SAYFA NO
				J_x (cm ⁴)	J_y (cm ⁴)	
	1895	Güneş Kırıcı Profili	1,290 kg/m	49,76	4,67	
	1896	Güneş Kırıcı Profili	1,047 kg/m	47,02	1,50	
	3283	Güneş Kırıcı Lameli Profili	0,618 kg/m	33,33	0,22	
	3282	Güneş Kırıcı Dikme Profili	1,327 kg/m	48,91	11,60	
	2255	Güneş Kırıcı Profili	0,870 kg/m	29,14	0,65	
	2256	Menfez Kasa Profili	0,535 kg/m	8,10	2,16	
	1456	40'lık Menfez Lameli Profili	0,385 kg/m	

GÜNEŞ KIRICI PROFİLLER

SUNBREAKER PROFILES

★ Yandaki profil birim ağırlıkları, bilgisayarda hesaplanmış teorik ağırlıklardır.

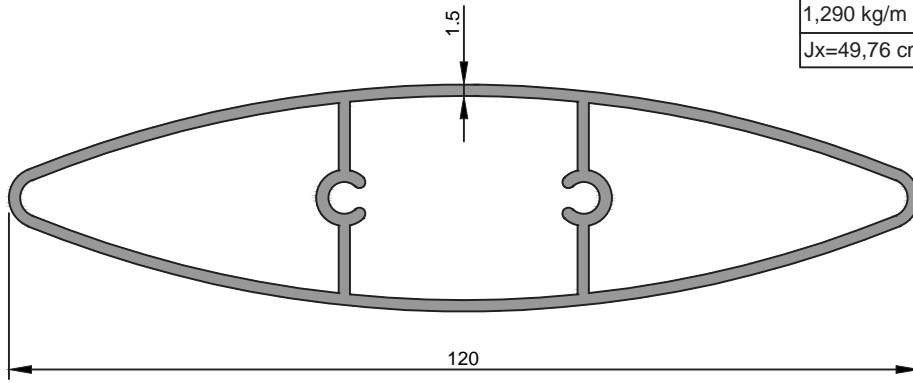

1895
Güneş Kırıcı Profili
1,290 kg/m
$Jx=49,76 \text{ cm}^4$ $Jy=4,67 \text{ cm}^4$

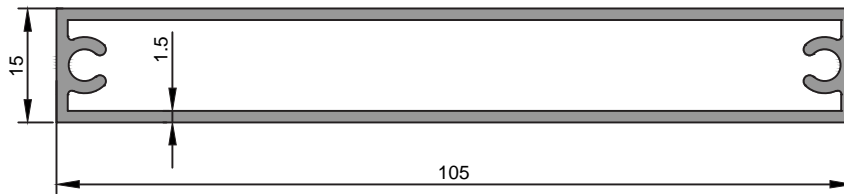

1896
Güneş Kırıcı Profili
1,047 kg/m
$Jx=47,02 \text{ cm}^4$ $Jy=1,50 \text{ cm}^4$

GÜNEŞ KIRICI PROFİLLER

SUNBREAKER PROFILES

★ Yandaki profil birim ağırlıkları, bilgisayarla hesaplanmış teorik ağırlıklardır.

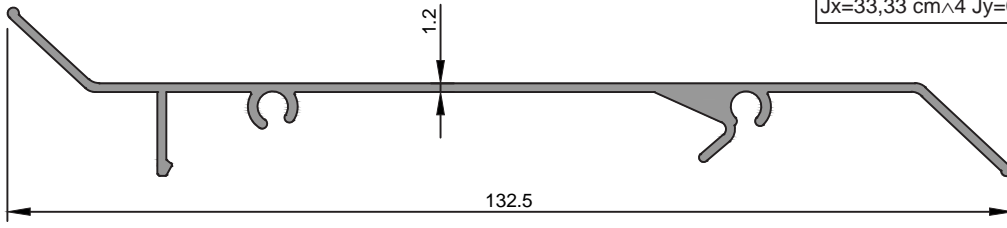

3283
Güneş Kırıcı Lameli Profili
0,618 kg/m
$J_x=33,33 \text{ cm}^4$ $J_y=0,22 \text{ cm}^4$

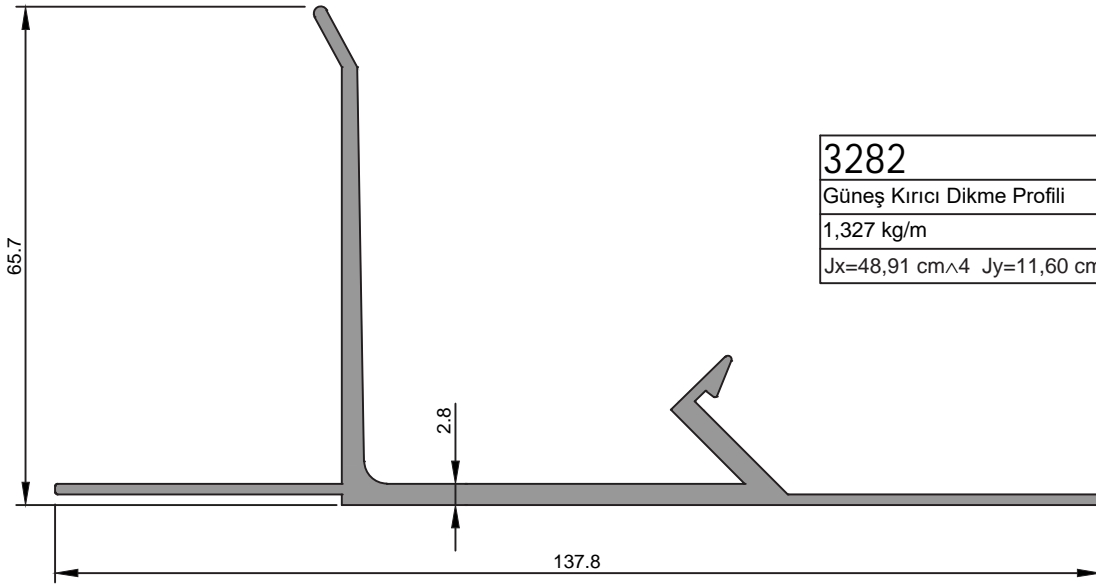

3282
Güneş Kırıcı Dikme Profili
1,327 kg/m
$J_x=48,91 \text{ cm}^4$ $J_y=11,60 \text{ cm}^4$

GÜNEŞ KIRICI PROFİLLER

SUNBREAKER PROFILES

★ Yandaki profil birim ağırlıkları, bilgisayarla hesaplanmış teorik ağırlıklardır.

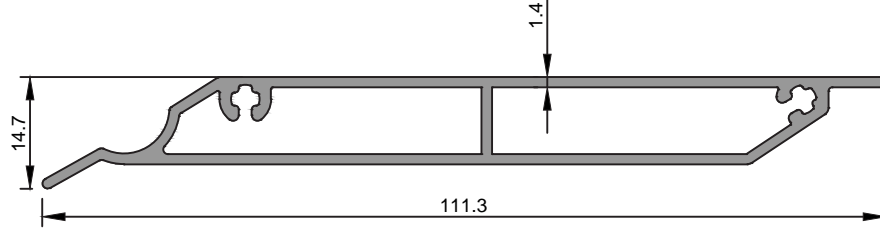

2255
Güneş Kırıcı Profili
0,870 kg/m
$Jx=29,14 \text{ cm}^4$ $Jy=0,65 \text{ cm}^4$

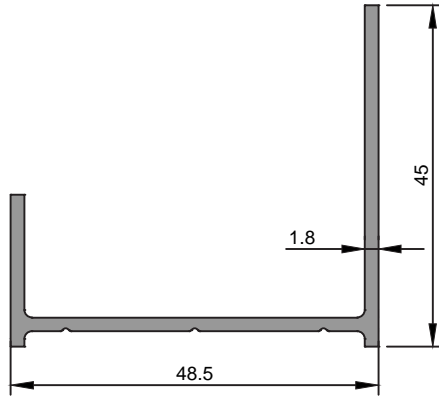

2256
Menfez Kasa Profili
0,535 kg/m
$Jx=8,10 \text{ cm}^4$ $Jy=2,16 \text{ cm}^4$

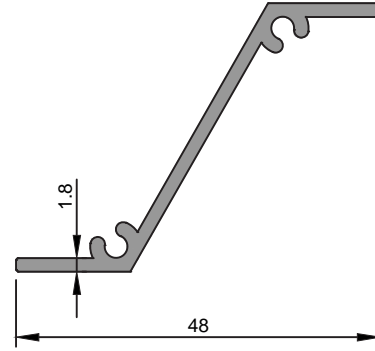

1456
40'luk Menfez Lameli Profili
0,385 kg/m

PROFİL KATALOĞU

ZEMİN PROFİLLER

FLOORING PROFILE















* Profil Ağırlıkları Teorik Olup Teslim Anındaki Ağırlık Geçerlidir

* *Weight of profiles are theoretical, net weight will valid at the time of delivery.*

ZEMİN PROFİLLERİ

FLOORING PROFILE













★ Yandaki profil birim ağırlıkları, bilgisayarda hesaplanmış teorik ağırlıklardır.

PROFİL KESİTİ	PROFİL KODU	PROFİL ADI	AĞIRLIK	ATALET MOMENTLERİ		SAYFA NO
				J_x (cm ⁴)	J_y (cm ⁴)	
	1822	...	0,158 kg/m	
	1253	...	0,116 kg/m	
	1752	...	0,126 kg/m	
	1254	...	0,64 kg/m	
	1572	...	1,92 kg/m	
	1774	...	0,96 kg/m	
	1746	...	0,99 kg/m	
	1031	...	0,133 kg/m	
	1795	...	0,87 kg/m	
	1475	...	0,183 kg/m	
	1295	...	0,151kg/m	
	2751	...	0,196 kg/m	
	1574	...	0,101 kg/m	
	1681	...	0,75 kg/m	

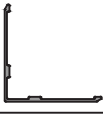
ZEMİN PROFİLLERİ

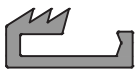
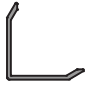
FLOORING PROFILE

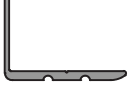













★ Yandaki profil birim ağırlıkları, bilgisayarda hesaplanmış teorik ağırlıklardır.

PROFİL KESİTİ	PROFİL KODU	PROFİL ADI	AĞIRLIK	ATALET MOMENTLERİ		SAYFA NO
				J_x (cm ⁴)	J_y (cm ⁴)	
	1773	...	0,97 kg/m	
	1781	...	0,110 kg/m	
	1780	...	0,144 kg/m	
	1775	...	0,141 kg/m	
	1575	...	0,105 kg/m	
	1571	...	0,81 kg/m	
	1577	...	0,57 kg/m	
	1862	...	0,252 kg/m	
	2082	...	0,177 kg/m	
	1272	...	0,322 kg/m	
	1573	...	0,108 kg/m	
	1700	...	0,140 kg/m	
	1810	...	0,155 kg/m	
	1268	...	0,101 kg/m	

ZEMİN PROFİLLERİ

FLOORING PROFILE















★ Yandaki profil birim ağırlıkları, bilgisayarda hesaplanmış teorik ağırlıklardır.

PROFİL KESİTİ	PROFİL KODU	PROFİL ADI	AĞIRLIK	ATALET MOMENTLERİ		SAYFA NO
				J_x (cm ⁴)	J_y (cm ⁴)	
	2051	...	0,216 kg/m	
	1784	...	0,130 kg/m	
	1387	...	0,137 kg/m	
	1019	...	0,162 kg/m	
	1568	...	0,85 kg/m	
	1861	...	0,250 kg/m	
	1652	...	0,168 kg/m	
	1390	...	0,424 kg/m	
	1389	...	0,225 kg/m	
	2083	...	0,232 kg/m	
	1691	...	0,272 kg/m	
	2357	...	0,341 kg/m	
	2358	...	0,163 kg/m	
	2241	...	0,226 kg/m	

ZEMİN PROFİLLERİ

FLOORING PROFILE















★ Yandaki profil birim ağırlıkları, bilgisayarda hesaplanmış teorik ağırlıklardır.

PROFİL KESİTİ	PROFİL KODU	PROFİL ADI	AĞIRLIK	ATALET MOMENTLERİ		SAYFA NO
				J_x (cm ⁴)	J_y (cm ⁴)	
	2353	...	0,98 kg/m	
	2354	...	0,111 kg/m	
	2828	...	0,146 kg/m	
	2781	...	0,282 kg/m	
	2352	...	0,103 kg/m	
	2752	...	0,148 kg/m	
	1142	...	0,128 kg/m	
	1683	...	0,118 kg/m	
	1257	...	0,123 kg/m	
	1730	...	0,113 kg/m	
	1074	...	0,83 kg/m	
	1823	...	0,121 kg/m	
	1552	...	0,103 kg/m	
	1397	...	0,118 kg/m	

ZEMİN PROFİLLERİ

FLOORING PROFILE





★ Yandaki profil birim ağırlıkları, bilgisayarda hesaplanmış teorik ağırlıklardır.

PROFİL KESİTİ	PROFİL KODU	PROFİL ADI	AĞIRLIK	ATALET MOMENTLERİ		SAYFA NO
				J_x (cm ⁴)	J_y (cm ⁴)	
	1757	...	0,101 kg/m	
	1917	...	0,144 kg/m	
	1651	...	0,156 kg/m	
	1660	...	0,155 kg/m	
	1602	...	0,158 kg/m	
	1570	...	0,138 kg/m	
	1576	...	0,134 kg/m	
	1777	...	0,116 kg/m	
	1793	...	0,104 kg/m	
	1783	...	0,108 kg/m	
	1782	...	0,101 kg/m	
	1616	...	0,142 kg/m	
	1274	...	0,138 kg/m	
	1032	...	0,162 kg/m	

ZEMİN PROFİLLERİ

FLOORING PROFILE

★ Yandaki profil birim ağırlıkları, bilgisayarda hesaplanmış teorik ağırlıklardır.

PROFİL KESİTİ	PROFİL KODU	PROFİL ADI	AĞIRLIK	ATALET MOMENTLERİ		SAYFA NO
				J _x (cm ⁴)	J _y (cm ⁴)	
	1380	...	0,146 kg/m	
	1229	...	0,106 kg/m	
	1669	...	0,424 kg/m	
	1320	...	0,686 kg/m	
	1792	...	0,519 kg/m	

ZEMİN PROFİLLERİ

FLOORING PROFILE

★ Yandaki profil birim ağırlıkları, bilgisayarla hesaplanmış teorik ağırlıklardır.

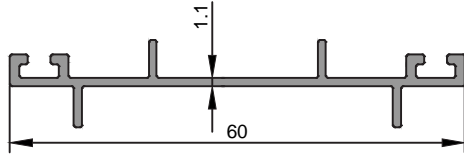

1755
0,290 kg/m

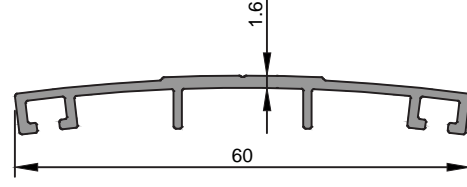

1756
0,319 kg/m

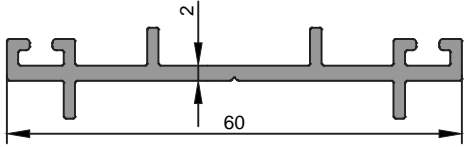

1121
0,486 kg/m

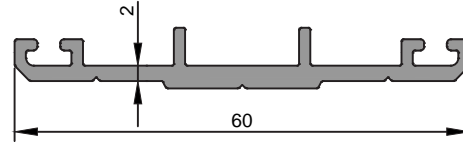

1222
0,490 kg/m

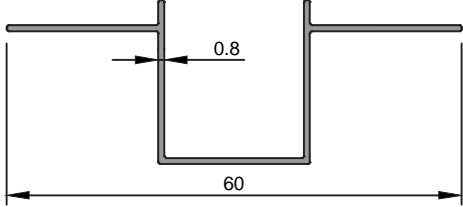

1831
0,220 kg/m

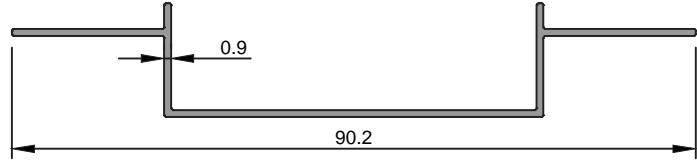

1834
0,288 kg/m

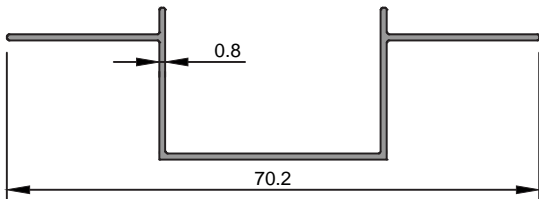

1832
0,235 kg/m

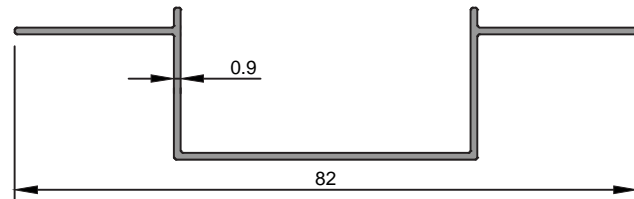

1833
0,293 kg/m

ZEMİN PROFİLLERİ

FLOORING PROFILE

★ Yandaki profil birim ağırlıkları, bilgisayarda hesaplanmış teorik ağırlıklardır.

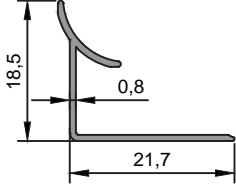

1574
0,101 kg/m

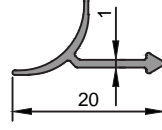

1681
0,75 kg/m

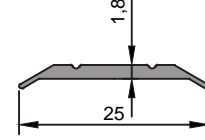

1773
0,97 kg/m

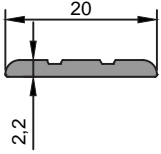

1781
0,110 kg/m

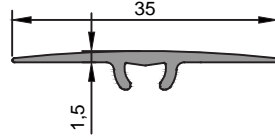

1780
0,144 kg/m

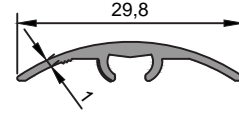

1775
0,141 kg/m

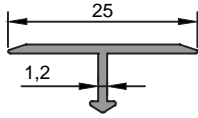

1575
0,105 kg/m

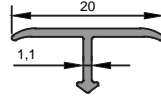

1571
0,81 kg/m

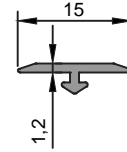

1577
0,57 kg/m

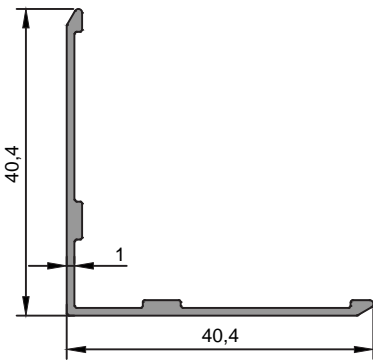

1862
0,252 kg/m

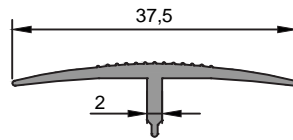

2082
0,177 kg/m

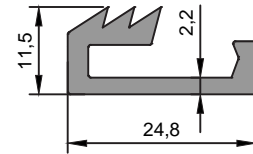

1272
0,322 kg/m

ZEMİN PROFİLLERİ

FLOORING PROFILE

★ Yandaki profil birim ağırlıkları, bilgisayarda hesaplanmış teorik ağırlıklardır.

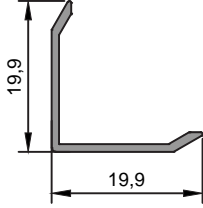

1573
0,108 kg/m

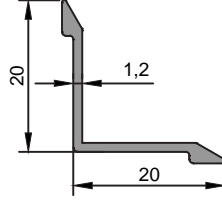

1700
0,140 kg/m

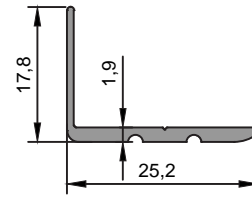

1810
0,155 kg/m

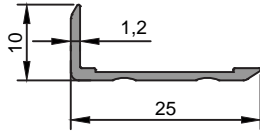

1268
0,101 kg/m

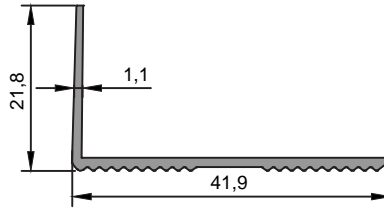

2051
0,216 kg/m

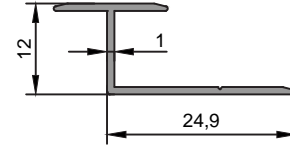

1784
0,130 kg/m

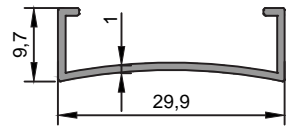

1387
0,137 kg/m

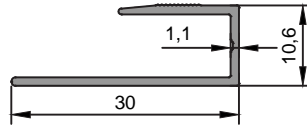

1019
0,162 kg/m

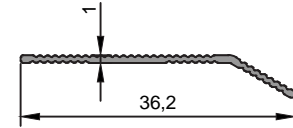

1568
0,85 kg/m

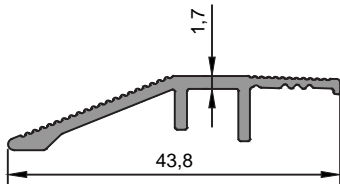

1861
0,250 kg/m

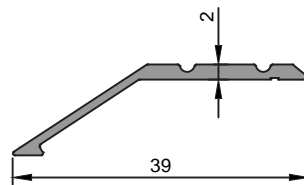

1652
0,168 kg/m

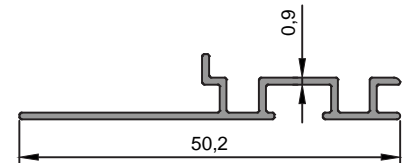

1390
0,424 kg/m

ZEMİN PROFİLLERİ

FLOORING PROFILE

★ Yandaki profil birim ağırlıkları, bilgisayarda hesaplanmış teorik ağırlıklardır.

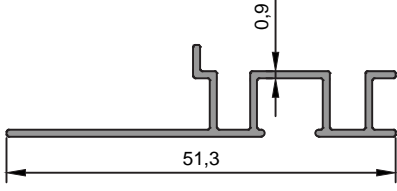

1389

0,225 kg/m

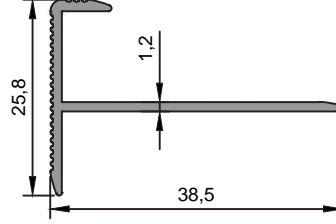

2083

0,232 kg/m

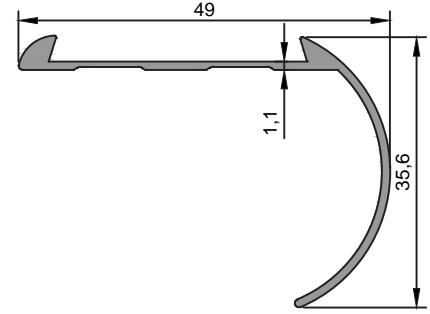

1691

0,272 kg/m

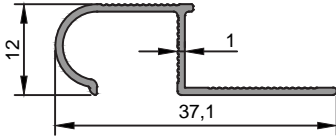

2357

0,341 kg/m

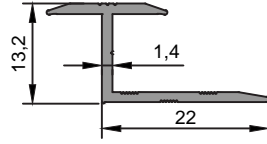

2358

0,163 kg/m

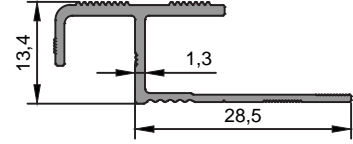

2241

0,226 kg/m

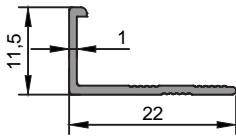

2353

0,98 kg/m

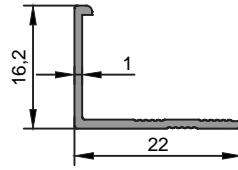

2354

0,111 kg/m

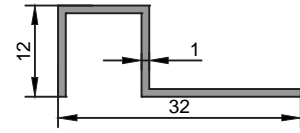

2828

0,146 kg/m

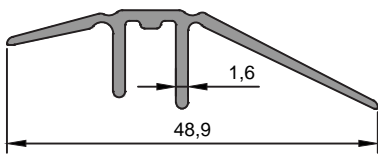

2781

0,282 kg/m

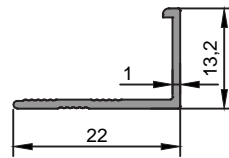

2352

0,103 kg/m

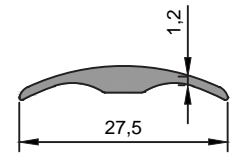

2752

0,148 kg/m

ZEMİN PROFİLLERİ

FLOORING PROFILE

★ Yandaki profil birim ağırlıkları, bilgisayarda hesaplanmış teorik ağırlıklardır.

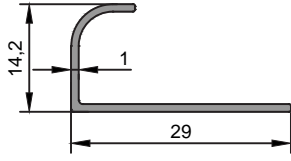

1142

0,128 kg/m

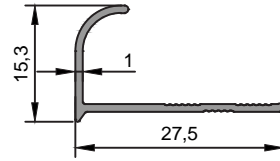

1683

0,118 kg/m

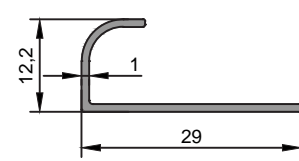

1257

0,123 kg/m

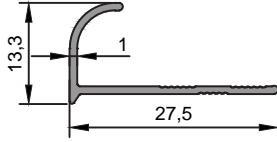

1730

0,113 kg/m

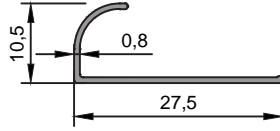

1074

0,83 kg/m

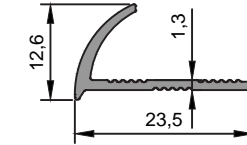

1823

0,121 kg/m

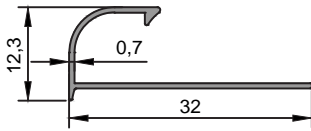

1552

0,103 kg/m

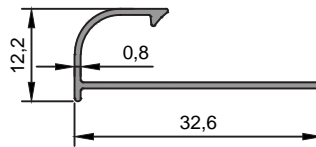

1397

0,118 kg/m

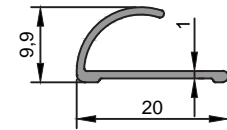

1757

0,101 kg/m

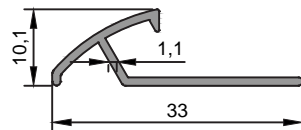

1617

0,144 kg/m

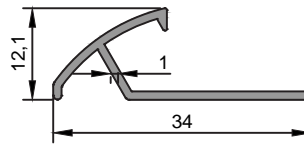

1651

0,156 kg/m

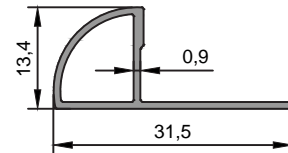

1660

0,155 kg/m

ZEMİN PROFİLLERİ

FLOORING PROFILE

★ Yandaki profil birim ağırlıkları, bilgisayarda hesaplanmış teorik ağırlıklardır.

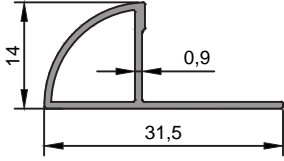

1602

0,158 kg/m

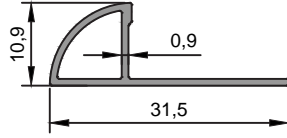

1570

0,138 kg/m

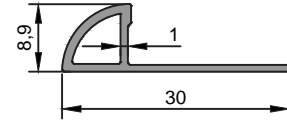

1576

0,134 kg/m

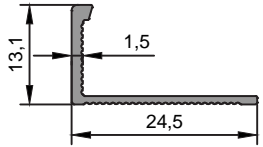

1777

0,116 kg/m

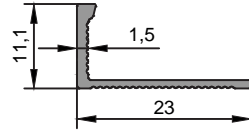

1793

0,104 kg/m

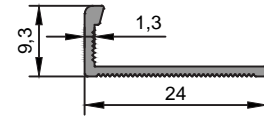

1783

0,108 kg/m

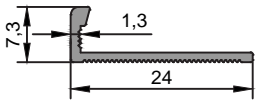

1782

0,101 kg/m

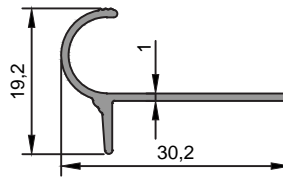

1616

0,142 kg/m

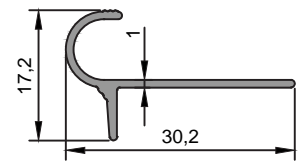

1274

0,138 kg/m

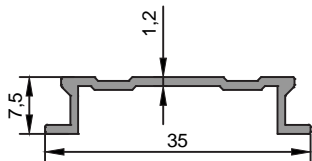

1032

0,162 kg/m

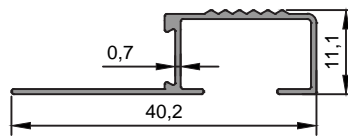

1380

0,146 kg/m

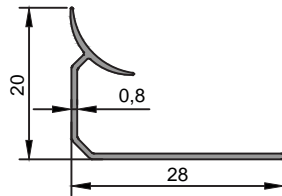

1229

0,106 kg/m

ZEMİN PROFİLLERİ

FLOORING PROFILE

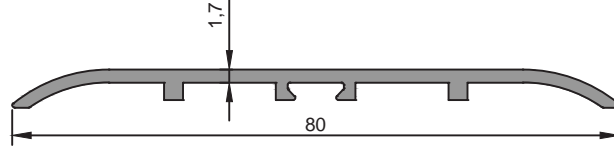

1669
0,424 kg/m

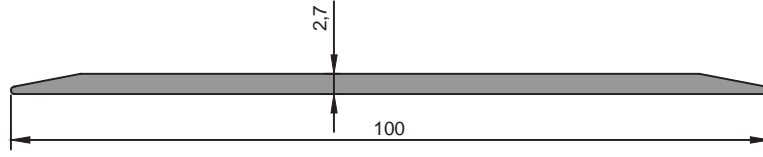

1320
0,686 kg/m

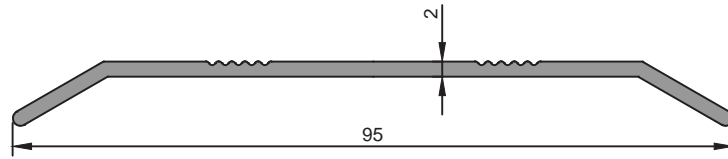

1792
0,519 kg/m

★ Yandaki profil birim ağırlıkları, bilgisayarda hesaplanmış teorik ağırlıklardır.

PROFİL KATALOĐU

PANJUR PROFİLLERİ

SHUTTER PROFILES









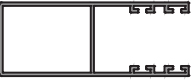
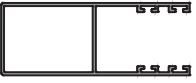
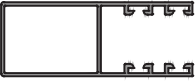

* Profil Ağırlıkları Teorik Olup Teslim Anındaki Ağırlık Geçerlidir

* *Weight of profiles are theoretical, net weight will valid at the time of delivery.*

PANJUR PROFİLLERİ

SHUTTER PROFILES

★ Yandaki profil birim ağırlıkları, bilgisayarda hesaplanmış teorik ağırlıklardır.

PROFİL KESİTİ	PROFİL KODU	PROFİL ADI	AĞIRLIK	ATALET MOMENTLERİ		SAYFA NO
				J_x (cm ⁴)	J_y (cm ⁴)	
	1324	Panjur Profili	1,296 kg/m	
	1686	Panjur Profili	1,133 kg/m	
	1323	Panjur Profili	0,880 kg/m	
	1322	Panjur Profili	0,591 kg/m	
	1325	Panjur Profili	0,409 kg/m	
	1685	Panjur Profili	0,588 kg/m	
	1138	Panjur Profili	0,580 kg/m	
	1326	Panjur Profili	0,585 kg/m	
	1558	Panjur Profili	0,601 kg/m	
	1327	Panjur Profili	0,451 kg/m	
	1562	Panjur Profili	0,353 kg/m	
	1556	Panjur Profili	0,381 kg/m	

PANJUR PROFİLLERİ

SHUTTER PROFILES

★ Yandaki profil birim ağırlıkları, bilgisayararda hesaplanmış teorik ağırlıklardır.

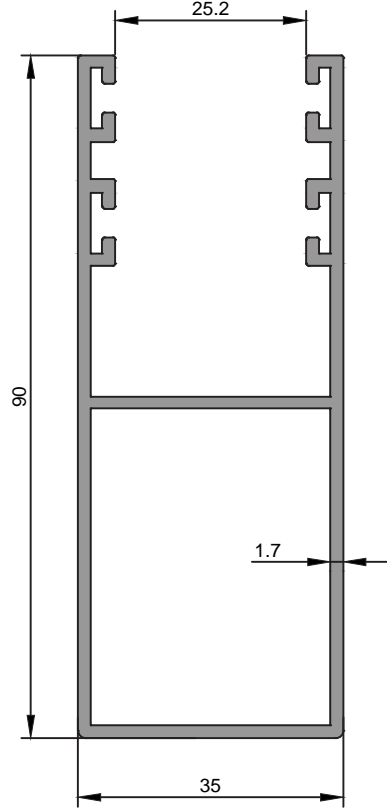

1324

Panjur Profili

1,296 kg/m

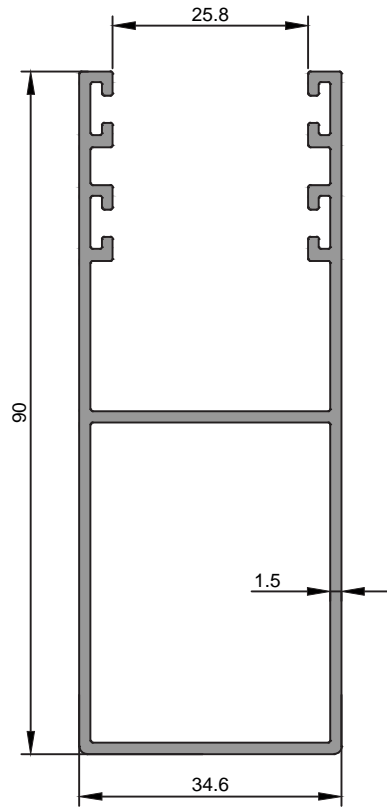

1686

Panjur Profili

1,133 kg/m

PANJUR PROFİLLERİ

SHUTTER PROFILES

★ Yandaki profil birim ağırlıkları, bilgisayarda hesaplanmış teorik ağırlıklardır.

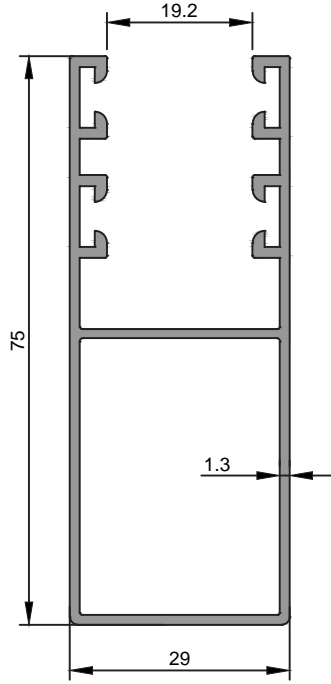

1323
Panjur Profili
0,880 kg/m

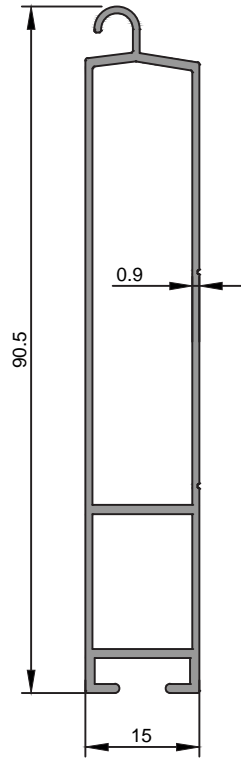

1322
Panjur Profili
0,591 kg/m

PANJUR PROFİLLERİ

SHUTTER PROFILES

★ Yandaki profil birim ağırlıkları, bilgisayarda hesaplanmış teorik ağırlıklardır.

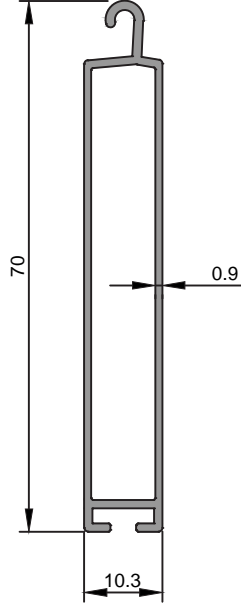

1325
Panjur Profili
0,409 kg/m

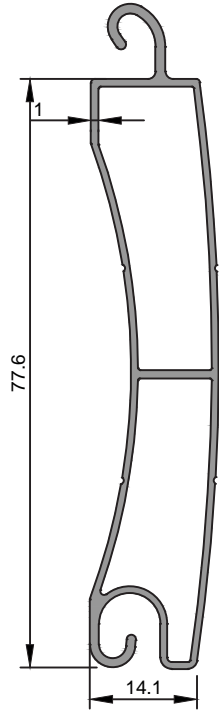

1685
Panjur Profili
0,588 kg/m

PANJUR PROFİLLERİ

SHUTTER PROFILES

★ Yandaki profil birim ağırlıkları, bilgisayarda hesaplanmış teorik ağırlıklardır.

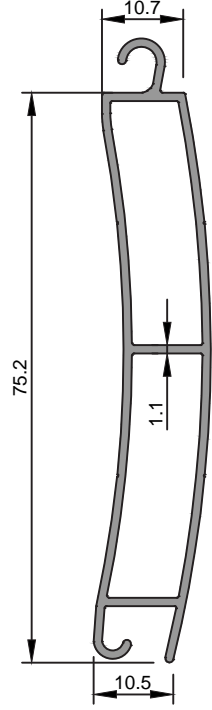

1138
Panjur Profili
0,580 kg/m

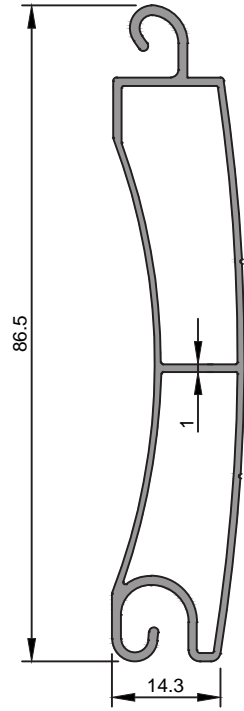

1326
Panjur Profili
0,585 kg/m

PANJUR PROFİLLERİ

SHUTTER PROFILES

★ Yandaki profil birim ağırlıkları, bilgisayararda hesaplanmış teorik ağırlıklardır.

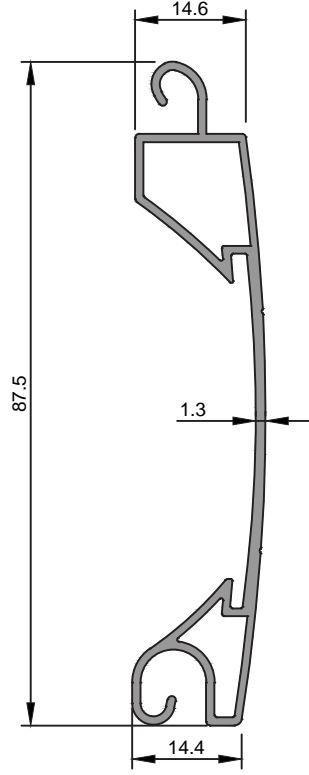

1558
Panjur Profili
0,601 kg/m

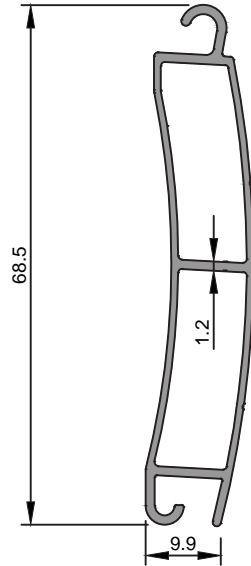

1327
Panjur Profili
0,451 kg/m

PANJUR PROFİLLERİ

SHUTTER PROFILES

★ Yandaki profil birim ağırlıkları, bilgisayarda hesaplanmış teorik ağırlıklardır.

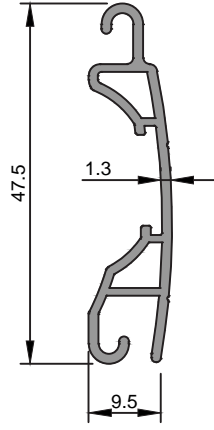

1562
Panjur Profili
0,353 kg/m

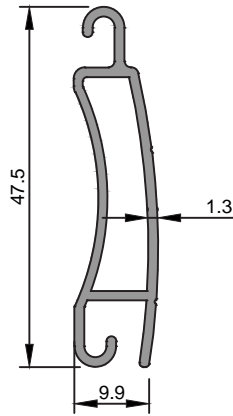

1556
Panjur Profili
0,381 kg/m

PROFİL KATALOĐU

DENİZLİK SÜPÜRGELİK PROFİLLERİ

WINDOWSILL , SKIRTING PROFILES

★ Profil Ağırlıkları Teorik Olup Teslim Anındaki Ağırlık Geçerlidir

★ *Weight of profiles are theoretical, net weight will valid at the time of delivery.*

DENİZLİK SÜPÜRGELİK PROFİLLERİ

WINDOWSILL , SKIRTING PROFILES

★ Yandaki profil birim ağırlıkları, bilgisayarda hesaplanmış teorik ağırlıklardır.

PROFİL KESİTİ	PROFİL KODU	PROFİL ADI	AĞIRLIK	ATALET MOMENTLERİ		SAYFA NO
				J_x (cm ⁴)	J_y (cm ⁴)	
	1455	...	0,456 kg/m	27,02	0,49	
	1136	...	0,593 kg/m	35,69	0,68	
	1653	...	0,276 kg/m	3,33	0,02	
	1778	...	0,201 kg/m	1,13	0,02	
	1779	...	0,364 kg/m	8,11	0,02	
	1205	...	0,375 kg/m	3,88	0,18	
	1786	...	0,420 kg/m	8,90	0,24	
	1785	...	0,328 kg/m	3,64	0,18	
	1206	...	0,120 kg/m	0,11	0,04	

DENİZLİK SÜPÜRGELİK PROFİLLERİ

WINDOWSILL , SKIRTING PROFILES

★ Yandaki profil birim ağırlıkları, bilgisayarda hesaplanmış teorik ağırlıklardır.

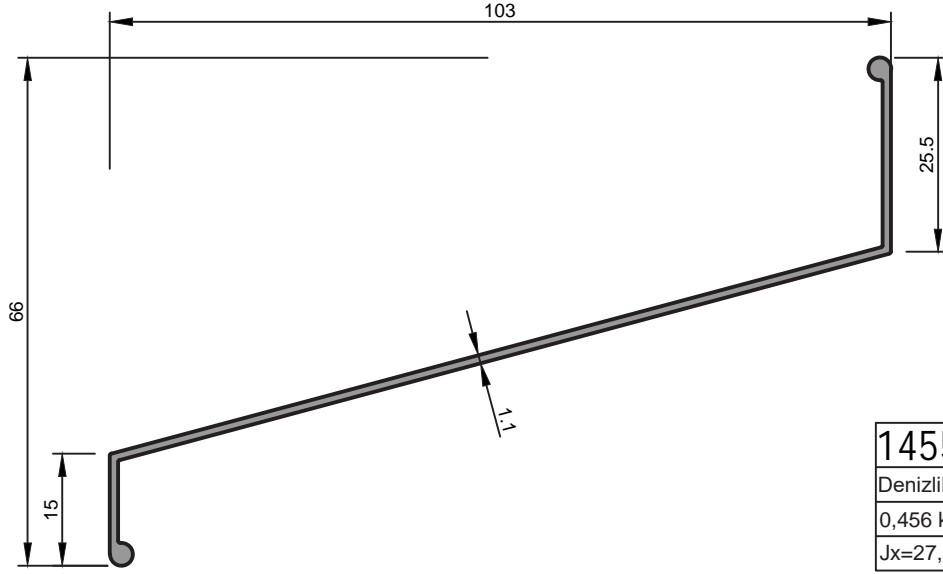

1455
Denizlik Süpürgelik Profili
0,456 kg/m
$J_x=27,02 \text{ cm}^4$ $J_y=0,49 \text{ cm}^4$

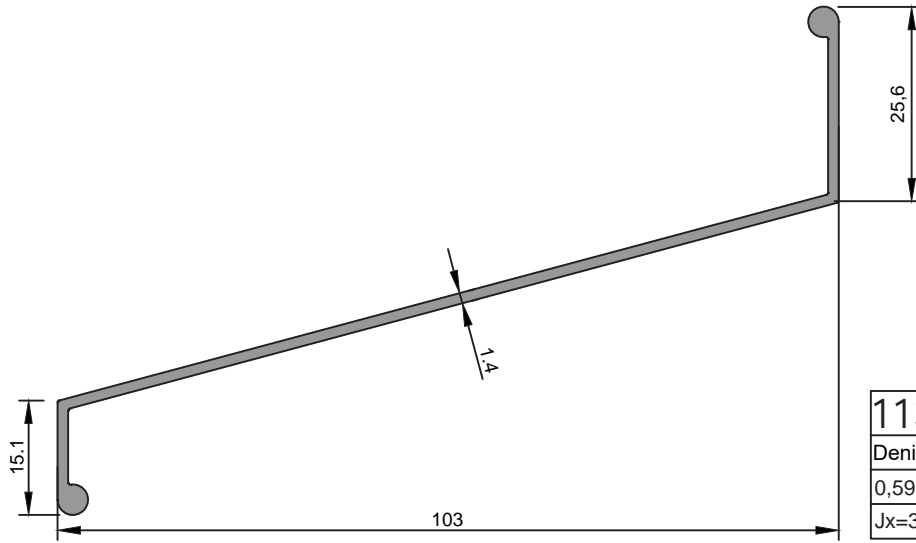

1136
Denizlik Süpürgelik Profili
0,593 kg/m
$J_x=35,69 \text{ cm}^4$ $J_y=0,68 \text{ cm}^4$

DENİZLİK SÜPÜRGELİK PROFİLLERİ

WINDOWSILL , SKIRTING PROFILES

★ Yandaki profil birim ağırlıkları, bilgisayarla hesaplanmış teorik ağırlıklardır.

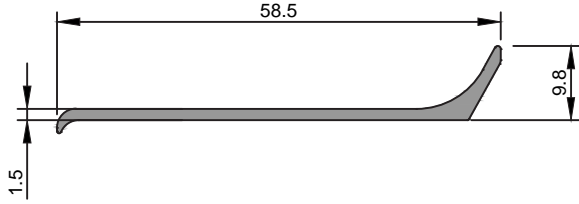

1653
Denizlik Süpürgelik Profili
0,276 kg/m
$Jx=3,33 \text{ cm}^4$ $Jy=0,02 \text{ cm}^4$

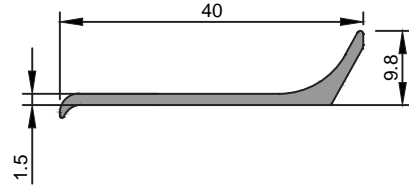

1778
Denizlik Süpürgelik Profili
0,201 kg/m
$Jx=1,13 \text{ cm}^4$ $Jy=0,02 \text{ cm}^4$

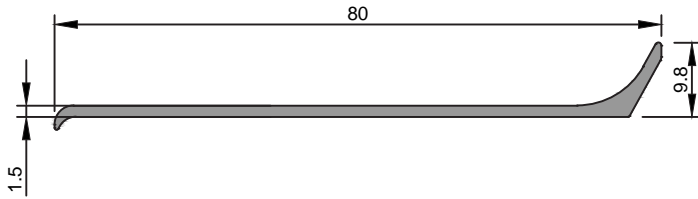

1779
Denizlik Süpürgelik Profili
0,364 kg/m
$Jx=8,11 \text{ cm}^4$ $Jy=0,02 \text{ cm}^4$

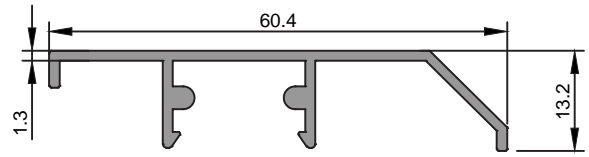

1205
Denizlik Süpürgelik Profili
0,375 kg/m
$Jx=3,88 \text{ cm}^4$ $Jy=0,18 \text{ cm}^4$

DENİZLİK SÜPÜRGELİK PROFİLLERİ

WINDOWSILL , SKIRTING PROFILES

★ Yandaki profil birim ağırlıkları, bilgisayarda hesaplanmış teorik ağırlıklardır.

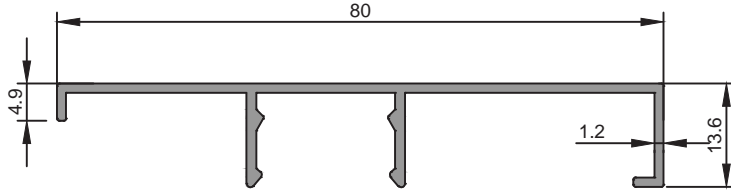

1786
Denizlik Süpürgelik Profili
0,420 kg/m
$J_x=8,90 \text{ cm}^4$ $J_y=0,24 \text{ cm}^4$

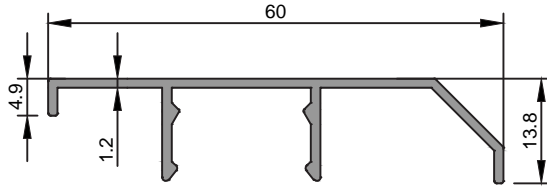

1785
Denizlik Süpürgelik Profili
0,328 kg/m
$J_x=3,64 \text{ cm}^4$ $J_y=0,18 \text{ cm}^4$

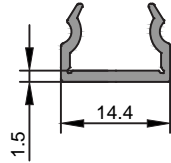

1206
Denizlik Süpürgelik Profili
0,120 kg/m
$J_x=0,11 \text{ cm}^4$ $J_y=0,04 \text{ cm}^4$

PROFİL KATALOĞU

BORU PROFİLLERİ

PIPE PROFILES

* Profil Ağırlıkları Teorik Olup Teslim Anındaki Ağırlık Geçerlidir

* *Weight of profiles are theoretical, net weight will valid at the time of delivery.*

BORU PROFİLLERİ

PIPE PROFILES

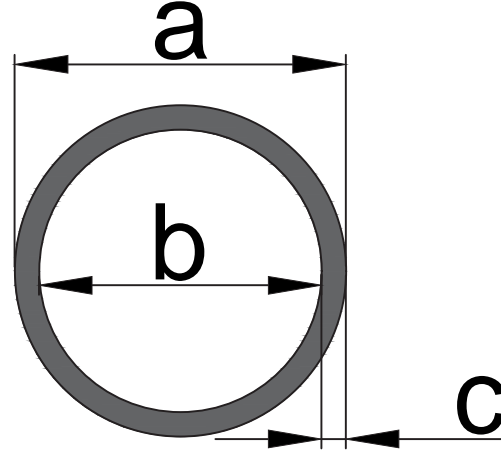

★ Yandaki profil birim ağırlıkları, bilgisayarla hesaplanmış teorik ağırlıklardır.

No	a	b	c	gr/m
1835	11,95	10,15	0,9	85
1540	12	10,1	0,95	89
1763	12	10,2	0,9	85
1525	12,8	10,4	1,2	244
1011	16	12	2	228
1063	16	13	1,5	185
1172	16	6	5	468
1308	16	8	4	409
1606	16	13,6	1,2	151
1804	16	14	1	128
1195	17	8,5	4,5	479
1006	18,4	16,4	1	148
1171	19,4	16,4	1,5	228
1220	20	12	4	545
1555	20	18	1	163
1863	20	18,1	0,95	154
2042	20	17	1,5	236
1146	24	18	3	536
2092	24	22	1	196
1281	24,5	18	3,25	588
1200	25	18	3,5	640
1419	25	23	1	204
1864	25	23,1	0,95	195
2041	25	22	1,5	300
2195	25	20	2,5	479
1048	30	24	3	690
1173	30	26	2	477
1215	30	10	10	1702

No	a	b	c	gr/m
1218	30	22	4	885
1418	30	28	1	246
1865	30	28,1	0,95	235
2193	30	23	3,5	789
1318	45	20,2	12,4	3441
1416	45	35	2	1703
1674	45	8	18,5	4174
2150	55	51	2,0	902
2736	35	31	2,0	562
2641	35	32	1,5	427
2640	35	32,4	1,30	373
2639	19	17	1,00	153
2569	38	35	1,50	466
1837	45	39	3	1072
1603	48	46	1	400
2068	49	27	11	3558
1046	50	45	2,5	1010
1047	50	45	2	1011
1417	50	40	5	1916
2025	50	46,7	1,65	679
2026	50	45,8	2,1	856
1054	50	47	1,5	620
2078	50,5	45	2,75	1118
1346	53	41	6	2400
1673	53	30	11,5	4061
1004	54	50,4	1,8	800
1076	58	20,4	18,8	6274
2495	50	47,4	1,30	539

No	a	b	c	gr/m
1679	60	54	3	1456
1980	60	56,4	1,8	891
1672	70	40,3	14,+7	6973
2000	70	67	1,5	874
2094	70	67,4	1,3	760
1331	80	74	3	1967
1053	40,2	10	15,1	3227
1104	39	30,4	4,3	1270
1147	60	55	2,5	1224
1169	40	36	2	647
1526	10	4	3	179
1541	10	8	1	77
1604	32	30	1	263
1738	32	26	3	1740
1739	45	42,6	1,2	447
1805	8	6	1	59
1836	9,7	8	0,85	64
1926	40	35	2,5	798
1836	8	5	1,5	83
2194	35	29	3	817
1929	8	5	1,5	83
1904	53	8	22,5	5842
2895	20	14	3	434
2928	25	10	7,2	1117
1363	49,9	46,4	1,75	717
2519	19	16,6	1,20	181
3459	32	25	3,5	848
2736	35	31	2	562
1054	50	47	1,5	620

DOLU BORU PROFİLLERİ

PIPE PROFILES

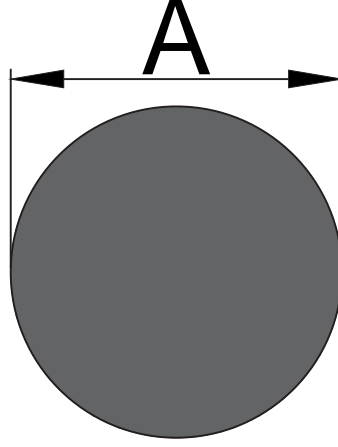

★ Yandaki profil birim ağırlıkları, bilgisayarda hesaplanmış teorik ağırlıklardır.

No	a	gr/m
1776	10	213
1212	16	545
1799	16	545
1381	18	689
1198	19,8	834
1234	22	1030
1197	24,95	1330
1328	30	1915
1329	35	2607
1165	41	3571
1167	51	5536
1282	55	6438
1166	60,5	7790
1227	65,5	9131
2786	16,3	566
2711	4,3	43
2451	6	77
2480	4,9	43

PROFİL KATALOĞU

DİKDÖRTGEN VE KARE PROFİLLER

RECTANGULAR AND SQUARE PROFILES

* Profil Ağırlıkları Teorik Olup Teslim Anındaki Ağırlık Geçerlidir

* *Weight of profiles are theoretical, net weight will valid at the time of delivery.*

KARE PROFİLLER

SQUARE PROFILES

★ Yandaki profil birim ağırlıkları, bilgisayarda hesaplanmış teorik ağırlıklardır.

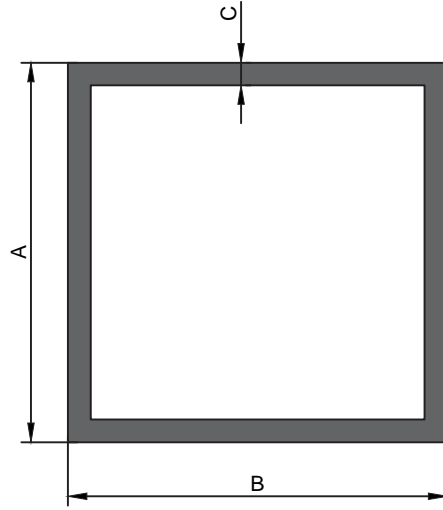

No	A	B	C	gr/m
1196	10	10	1,8	160
1737	12	12	1	119
1992	15	15	2	282
1990	20	20	2	390
1400	20	20	2,1	407
2151	22	22	2	434
1642	25	25	2	499
2578	25	25	1,2	310
1471	30	30	2	607
1352	35	35	1,2	440
1362	40	40	0,8	340
1068	40	40	1,1	464
1344	40	40	2	824
2415	60	60	1,4	889
3123	39,7	39,7	0,8	237
1465	50	50	2	1040
2939	80	80	2	1691

DİKDÖRTGEN PROFİLLER

RECTANGULAR PROFILES

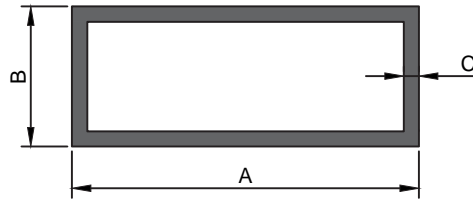

No	A	B	C	gr/m
1420	20	10	1	152
1614	20	10	1,2	180
1069	25	17	1,2	258
1513	25	17	2	412
1400	20	20	1,9	579
1066	40	20	1,2	375
1022	60	20	2	624
1624	80,2	20,2	0,86	453
1433	100	20	0,95	608
1869	100	25	1,3	862
2280	100	25	1,8	1184
1991	40	30	2	715
1415	50	30	2	824
1887	50	30	3	1185
1680	60	30	2	932
1426	70	32	0,8	435
1056	75	32	1,2	680
2421	45	35	1,75	726
1353	50	35	1,2	537
1067	50	40	1,2	570
1410	50	40	1,5	707
2414	95	50	1,5	1154
2423	80	75	1,5	1236
2555	30	20	2	499
2826	80	60	2	1142

★ Yandaki profil birim ağırlıkları, bilgisayarda hesaplanmış teorik ağırlıklardır.

PROFİL KATALOĞU

KÖŞEBENT, T, U VE LAMA PROFİLLERİ

KÖŞEBENT, T, U AND FLAT BAR PROFILES

* Profil Ağırlıkları Teorik Olup Teslim Anındaki Ağırlık Geçerlidir

* *Weight of profiles are theoretical, net weight will valid at the time of delivery.*

KÖŞEBENT PROFİLLERİ

BRACKET PROFILES

★ Yandaki profil birim ağırlıkları, bilgisayarla hesaplanmış teorik ağırlıklardır.

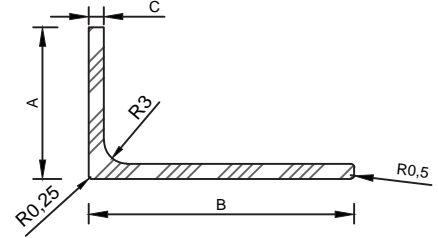
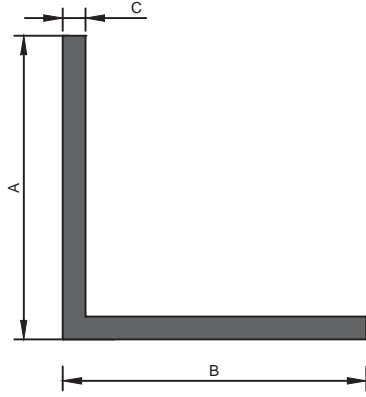

No	A	B	C	gr/m
1772	10	10	1,2	0,61
1127	10	15	1,2	0,77
1771	10	20	1,2	0,94
2300	10	20	2	0,152
1036	14	22	2,4	0,219
1693	15	15	1,4	0,109
1806	15	15	1,5	0,116
2427	15	15	3	0,220
1113	19	30	1,2	0,142
1313	20	19	0,8	0,81
1258	20	20	0,8	0,85
1128	20	20	1,2	0,126
1341	20	20	2	0,206
1342	20	25	2	0,233
1796	20	30	1	0,133
1350	20	30	2	0,260
1769	20	40	1	0,160
1112	20	40	1,2	0,191
1539	20	40	2	0,314
1707	20	53,2	2	0,386
1111	20	60	1,2	0,256
2416	20	80	1,5	0,400
1137	15	15	1,2	0,93

No	A	B	C	gr/m
1105	20	60	1,5	320
1247	25	25	0,8	107
1129	25	25	1,2	159
1514	25	25	2	260
1037	25	25	2,4	310
1706	27,7	53,2	2	427
1250	30	30	0,8	128
1110	30	30	1,2	191
1466	30	30	2	314
1343	30	30	3	463
2534	30	30	1,5	238
1829	30	50	3	626
1108	40	40	1,2	256
1107	40	40	2	422
1114	40	40	4	823
1115	40	60	2	531
2028	40	60	2,5	660
1109	50	50	1,5	398
2283	50	50	3	788
1106	50	50	5	1287
1839	50	85	4	1420
2768	50	20	1,2	224

No	A	B	C	gr/m
1365	54	60	3	907
1367	54	80	3	1070
1370	54	100	3	1230
1369	54	120	3	1395
1748	25	50	1,8	356
1368	25	50	2	395
3432	33	20	1	141
3425	35	25	2	315
3426	25	40	2	342
2518	25	25	1	258
2538	50	35	4	878
2512	80	120	2	1073
2511	50	50	2	531
2510	25	50	2	396
2305	20	20	2	203

T PROFİLLERİ

T PROFILES

★ Yandaki profil birim ağırlıkları, bilgisayarda hesaplanmış teorik ağırlıklardır.

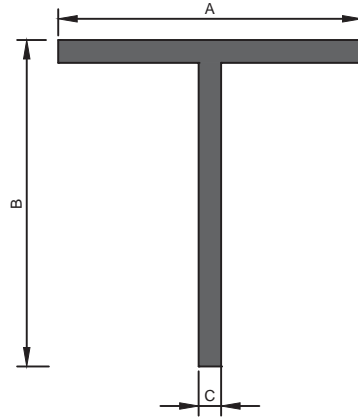

No	A	B	C	gr/m
1123	20	20	1,5	157
1125	20	20	2	206
1124	25	25	2	260
1126	30	30	1,2	191
1564	30	30	1,5	238
1635	30	30	3	463
1639	50	50	2	531
1797	100	60	2	856
2029	100	60	2,5	1067
1809	110	30	2	748
2455	110	50	2	833
2509	100	52	2	813

U PROFİLLERİ

U PROFILES

★ Yandaki profil birim ağırlıkları, bilgisayarla hesaplanmış teorik ağırlıklardır.

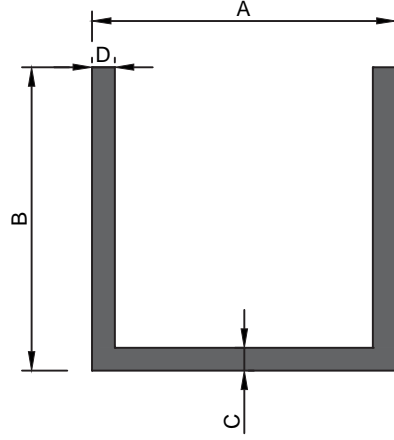

No	A	B	C	D	gr/m
1018	8	19,9	1	1	122
1294	10	20	0,8	0,8	105
1807	13	15	1,5	1,5	163
1949	15	23,5	1,6	1,6	255
1201	25	20	1,2	1,2	203
1629	42	5	1	1	190
1791	48	18,8	1	1	226
1790	50	20	1	1	238
1145	8,2	8,1	0,9	0,9	55
1894	50	50	3	3	1170
1788	69	18,8	1	1	283
3191	21	25	1,2	1,2	223
2777	111	30	2	3	1138
2567	40	20	2	2	412
2247	40	30	1,5	1,5	394

No	A	B	C	D	gr/m
1789	70	20	1	1	292
1634	40	30	2	2	667
1950	50	30	3	3	255
2242	105	11	2	2	661
2301	26	8	2	2	206
2443	20	20	1,5	1,5	233
2537	40	40	4	4	1214
2606	9,8	6	1	1	54
2780	17	17	1,1	1,1	145
2789	14,8	9,4	1,6	1,6	131

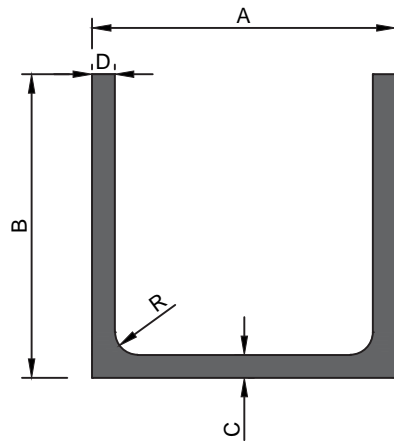

No	A	B	C	D	R	gr/m
3333	23	20	25	25	2	422

LAMA PROFİLLERİ

FLAT BAR PROFILES

★ Yandaki profil birim ağırlıkları, bilgisayararda hesaplanmış teorik ağırlıklardır.

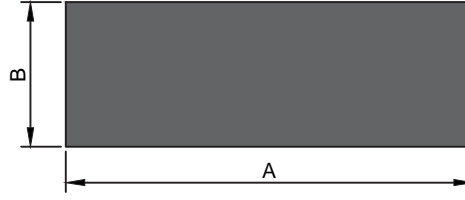

No	A	B	gr/m
1770	10	2	54
1140	15	2,5	102
1958	17	8	369
1029	19,5	4,5	238
1055	20	3	163
2288	20	2	108
1648	20	20	1084
1729	25	25	1694
2282	30	3	244
1938	30	5	407
1959	30	8	650
1351	34	4,8	440
1450	34	3	275
1321	40	3	325
3205	28	23	1745

No	A	B	gr/m
1703	40	5	542
1030	44	10	1192
2366	45	2	244
1448	50	6	813
2424	50	1,5	203
2492	60	1,3	211
1973	60	5	813
2196	70	1,5	285
2425	70	1,6	304
1702	70	8	1518
2888	80	1,4	304
2889	100	1,5	407
1519	100	4	1084
1509	100	5	1355

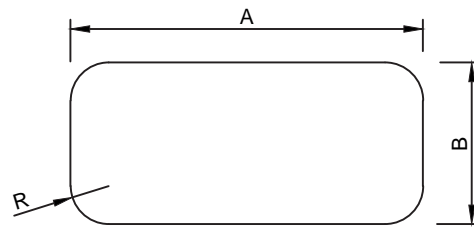

No	A	B	R	gr/m
2529	1485	9.9	1	314



ALCER GLOBAL METAL ENDÜSTRİ LTD. ŞTİ.

İzzetpaşa Mah. Yeni Yol Cad. Nurol Tower

No: 3 Kat:2 Şişli /Istanbul ,TR

Tel : +90 212 709 74 64

Mobile: +90 535 951 87 52

Email: info@alcerglobal.com

Web: www.alcerglobal.com